

# Slots & Dots

48V Low Voltage Track  
Deep Profile Pendant/  
Surface



## TRACK



SD-TSD

## Features

Slots & Dots, a 48V Track lighting system, connects all the dots for architects and lighting designers: color, comfort, controls and configurability. Slots & Dots is an easily configurable low voltage track lighting system that creates visual ambience for hospitality, residential, commercial and retail environments. Featuring surface, recessed or pendant mounting options, with easy light module in linear and accent that can be easily snapped in and out as needed. Slots are made up of linear modules to create visual interest, wall grazing and glare free accent. Dots deliver focused beams of light from either an accent pendant or surface mounted accent that bring items into focus.

## PROJECT:

### SLOTS & DOTS

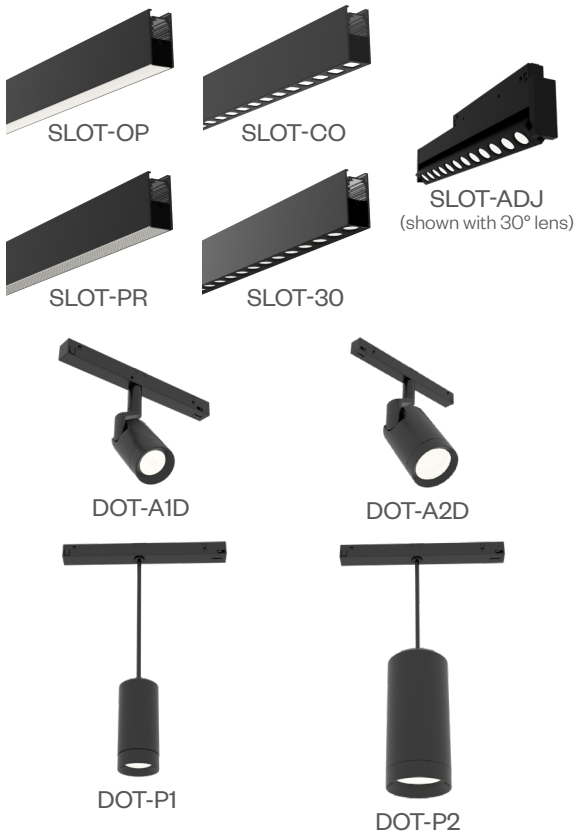

## TYPE:

### Product Overview

#### Track (SD-TSD) Deep Profile Pendant/Surface

Type	48V Low Voltage Track
Circuit(s)/Amps:	1 circuit + Data Bus: $\pm 15A/0-48V + D+/D-$
Voltage:	48V
Weight (lbs):	2.9 (4'), 5.8 (8')

#### Slots (SLOT-xx) (Linear Modules)

Type:	48V Track Linear System
Watts:	6W/ft
Lumen Output:	490 lm (OP), 343 lm (PR), 511 lm (CO), 527 lm (30)
Color Temp:	2700K, 3000K, 3500K, 4000K
CRI:	90 typ.
Driver:	DALI 1% dim, 0-10V 1% dim

Weight (lbs):						
	1'	2'	4'	1'	2'	
SLOT-OP	0.4	0.7	1.3	SLOT-ADJ-CO	0.45	0.9
SLOT-PR	0.4	0.7	1.4	SLOT-ADJ-30	0.45	0.9
SLOT-CO	0.5	0.9	1.8	SLOT-ADJ-26x42	0.45	0.9
SLOT-30	0.5	0.9	1.7			

#### Dots (DOT-Ax/DOT-Px) (Accent Modules)

Type:	48V Track Accent & Pendant System
Watts (per head):	Small - 7W (A1/P1) Large - 16W (A2/P2)
Lumen Output:	391 lm (A1/P1), 1206 lm (A2/P2)
Color Temp-CRI:	Small - 3500K-80, 4000K-80, 2700K-90+, 3000K-90+ Large - 2200K-90+, 2700K-90+, 3000K-90+, 3500K-90+, 4000K-90+, CrispWhite, 3K Class A
Driver:	DALI 1% dim, 0-10V 1% dim
Weight (lbs):	0.4 (DOT-A1), 0.8 (DOT-A2) 0.6 (DOT-P1), 1.1 (DOT-P2)



(JA8/Title 24 compliant on DOT models with certain options (see pg 6))

# Slots & Dots

48V Low Voltage Track, Deep Profile Pendant/Surface



## PROJECT:

## TYPE:

### Track Ordering Information



- 1** Track Model  
**SD-TSD-4** - pendant/surface deep profile track, 48"  
**SD-TSD-8** - pendant/surface deep profile track, 96"  
**Note: All tracks are field cuttable. SD-TOOL is required for cutting track conductors (ordered separately, see Accessories below)**

- 2** Finish  
**B** - black  
**W** - white

### Component Ordering Information



- 1** End Cap  
 (1 required for each end of track run)  
**SD-EC-TD** - end cap  
**SD-EC-F-TD** - end cap with feed hole
- Connectors  
 (required to make electrical connection between tracks)  
**SD-CNS-POL** - middle connector, polarized, straight  
**SD-CNS-M** - middle connector, mechanical, non-electrical  
**SD-LF-I** - L connector, same plane, polarized, internal  
**SD-LF-E** - L connector, same plane, polarized, external  
**SD-XF-POL\*** - flex connector, wall to ceiling, polarized  
**SD-T-I-R** - T connector, polarized, internal right  
**SD-T-I-L** - T connector, polarized, internal left  
**SD-T-E-R** - T connector, polarized, external right  
**SD-T-E-L** - T connector, polarized, external left  
**SD-X** - X connector, polarized

*\* Can be used as in-plane with variable angle*

- Mechanical Joints  
**SD-90D-S** - L joint, mechanical  
**SD-90D-CG-S** - L joint with cable gripper, mechanical  
**SD-TD** - T joint, mechanical  
**SD-TD-CG** - T joint with cable gripper, mechanical  
**SD-XD** - X joint, mechanical  
**SD-XD-CG** - X joint with cable gripper, mechanical

- End Feed  
 (1 live feed required for feed end of track)  
**SD-SF-L-POL** - end feed, polarized, left, straight  
**SD-SF-R-POL** - end feed, polarized, right, straight

- Mounting Kits  
Pendant Mount:  
Power Feed Canopy Kit  
 (1 kit for feed end of track, includes 10' mounting cable w/gripper)  
**SD-FCAN-S** - canopy/feed kit with bracket
- Non-Power Feed Canopy Kits/Aircraft Cable  
 (1 kit for every 36" of track, 55lbs max load)  
**SD-CAN-L** - canopy kit with sliding suspension bracket  
**636-0264** - canopy kit, black (when suspending to L, T, X Connector with cable gripper)  
**636-0268** - canopy kit, white (when suspending to L, T, X Connector with cable gripper)  
**SD-CABLE** - 10' mounting cable with gripper & sliding suspension bracket  
**614-0004** - aircraft cable (with eyehook) only, 10'

**See Mounting example on page 13**

- Surface Mount:  
T-Bar Clip Kit  
**SD-916TKIT** - 9/16 T-Bar clip kit  
**SD-1516TKIT** - 15/16 T-Bar clip kit



- Accessories  
**SD-4BLANK** - 48" blank to cover track without light module  
**SD-8BLANK** - 96" blank to cover track without light module  
**SD-TOOL** - cutting tool for track conductors  
**Note: All Blank sections are field cuttable**

- 2** Finish  
**B** - black  
**W** - white

### Transformer Ordering Information



- 1** Transformer (connect with 18AWG wire, plenum rated cable supplied, 30' max distance fixture to transformer, 120/277 input, 48V DC output)  
**TR-48V100W** - 100W, 48V transformer with enclosure\*, capable of providing 80W of power  
**TR-48V260W** - 260W, 48V transformer with enclosure\*, capable of providing 208W of power  
**TR-48V320W** - 320W, 48V transformer with enclosure\*, capable of providing 256W of power

**\* Enclosure size: 15 1/16" x 4 5/16" x 2 3/16"**

**Note: Ensure that the transformer does not exceed 80% of the total wattage in order to maintain its optimal performance.**

**See pg 13 for voltage drop & max track length information.**

# Slots & Dots

48V Low Voltage Track, Deep Profile Pendant/Surface



## PROJECT:

## TYPE:

### Specifications - Track

#### 48V Low Voltage Track

##### Application

48V power supply for Amerlux® track lighting fixtures, 18AWG, 15 Amp

##### Construction

Architectural grade, extruded aluminum housing  
Milled grounding bar provides continuous ground contact  
Continuously crimped conductor ensures mechanical strength and electrical reliability

##### Finish

Black or white

##### Mounting

Surface or pendant mounted  
Max "on center" suspension points, see page 5

##### Certifications

cUL listed for dry locations only

## TRACK

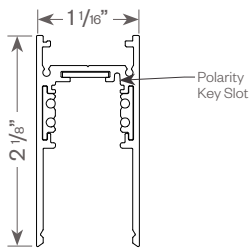

SD-TSD



Max Load: 55 lbs

### SURFACE MOUNT DETAILS

Mount holes 1' from ends and then every 2'.

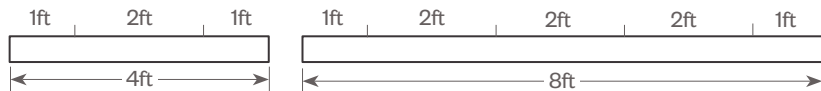

## END CAPS

### For SD-TSD Track

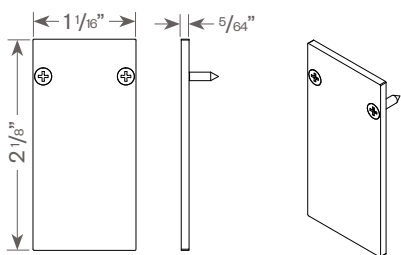

SD-EC-TD

(Required on each end of a track run)

### With Feed hole

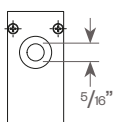

SD-EC-F-TD

(Required when feeding track from the side)

# Slots & Dots

48V Low Voltage Track, Deep Profile Pendant/Surface



Slots & Dots - 48V LVT-Deep Profile P/S

## PROJECT:

## TYPE:

### END FEED

#### End Feed

##### Left Polarity

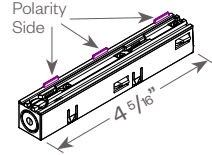

**SD-SF-L-POL**

##### Right Polarity

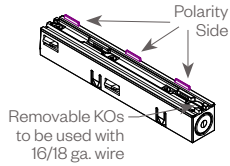

**SD-SF-R-POL**

### CONNECTORS

#### Middle Straight Connector

##### Polarized

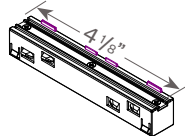

**SD-CNS-POL**

##### Mechanical (non-electrical)

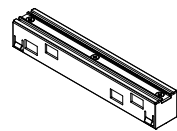

**SD-CNS-M**

**(Used to create dead ends in between two sections of track)**

#### L Connector

##### Internal Polarity

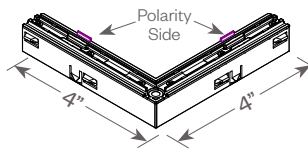

**SD-LF-I**

##### External Polarity

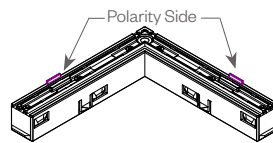

**SD-LF-E**

#### Flex Connector

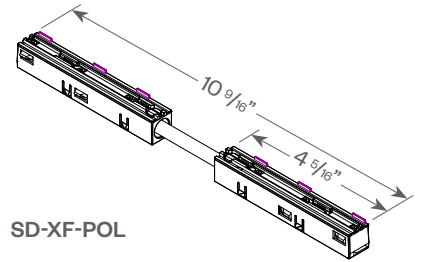

**SD-XF-POL**

#### Note:

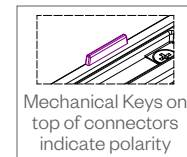

## MOUNTING KITS

### PENDANT MOUNT:

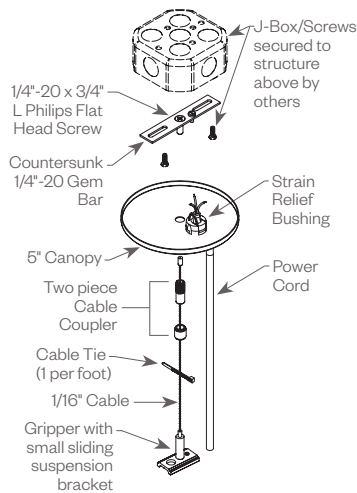

**Power Feed**  
(with sliding suspension bracket)

**SD-FCAN-S**

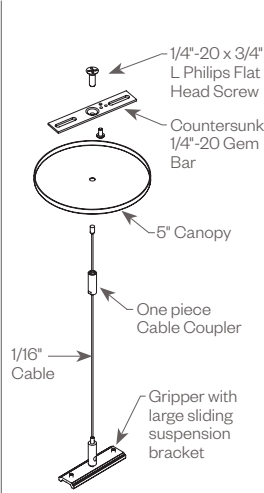

**Non-Power Feed**  
(with sliding suspension bracket)

**SD-CAN-L**

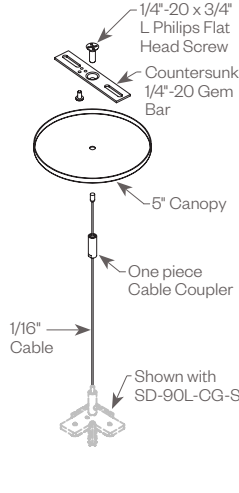

**Non-Power Feed**  
(when suspending to L, T, X Connector with cable gripper)

**636-0264 (black)**  
**636-0268 (white)**

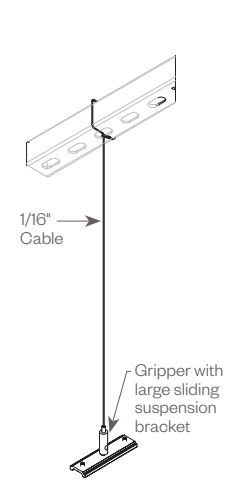

**Wrap Around**  
(with sliding suspension bracket)

**SD-CABLE**

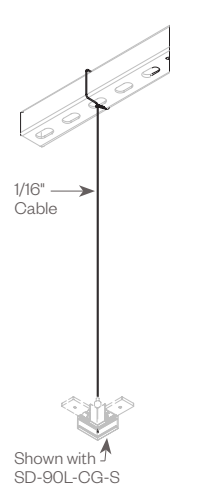

**Wrap Around Aircraft Cable only**  
(when suspending to L, T, X Connector with cable gripper)

**614-0004**

### SURFACE MOUNT:

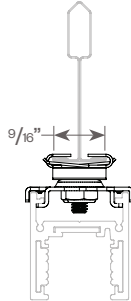
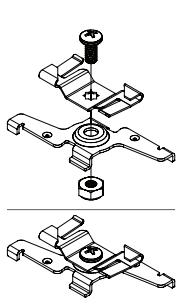

#### 9/16 T-Bar Clip

**SD-916TKIT-B (black)**  
**SD-916TKIT-W (white)**

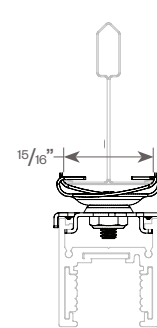
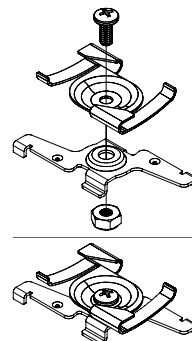

#### 15/16 T-Bar Clip

**SD-1516TKIT-B (black)**  
**SD-1516TKIT-W (white)**

# Slots & Dots

48V Low Voltage Track, Deep Profile Pendant/Surface



**PROJECT:**

**TYPE:**

## POLARIZED FEEDS

**Polarized T Feed  
(Internal Right)**

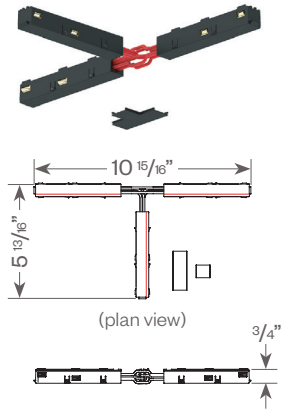

Covers (x2) included



**SD-T-I-R**

**Polarized T Feed  
(Internal Left)**

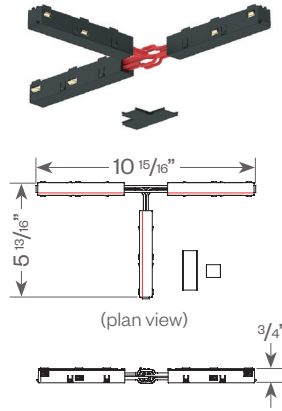

Covers (x2) included



**SD-T-I-L**

**Polarized T Feed  
(External Right)**

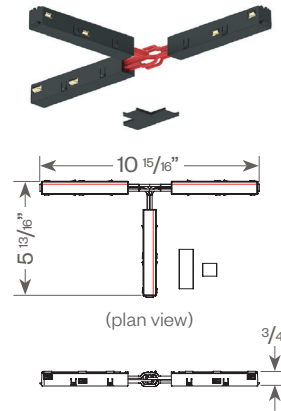

Covers (x2) included



**SD-T-I-E**

**Polarized T Feed  
(External Left)**

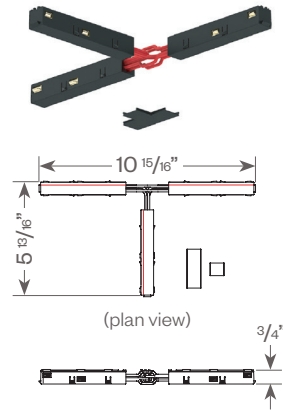

Covers (x2) included

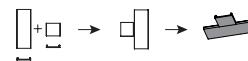

**SD-T-E-L**

**Polarized X Feed**

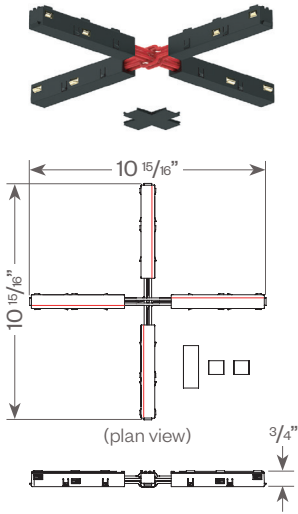

Covers (x3) included

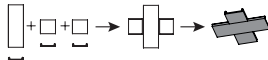

**SD-X**

## MECHANICAL JOINTS

**L - Joint**

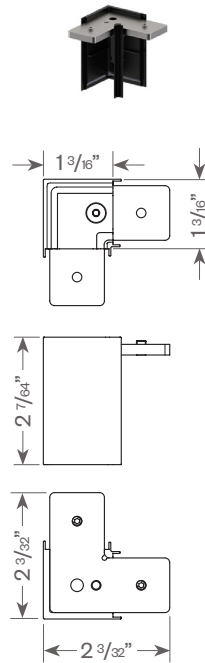

**SD-90D-S**

With Aircraft Cable Gripper attached:

**SD-90D-CG-S**

**T - Joint**

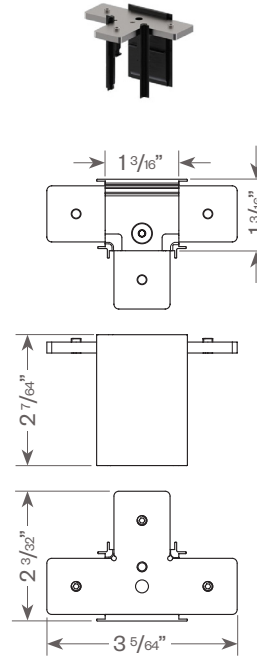

**SD-TD**

With Aircraft Cable Gripper attached:

**SD-TD-CG-S**

**X - Joint**

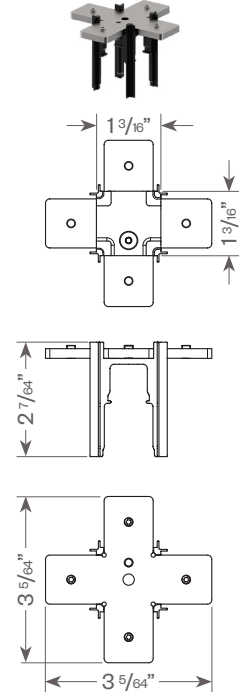

**SD-XD**

With Aircraft Cable Gripper attached:

**SD-XD-CG-S**



# Slots & Dots

48V Low Voltage Track, Deep Profile Pendant/Surface



## PROJECT:

## TYPE:

### Specifications - Light Modules

#### Slots (Linear Light Module)

##### Application

Hospitality and retail task lighting

##### Construction

Extruded aluminum heatsink  
No exposed wiring

##### Optical

Lens options: Opal, Microprismatic, Comfort or 30°

##### LED

Color Temp Options: 2700K, 3000K, 3500K, 4000K  
CRI: 90 typ.  
Binning: 3 MacAdam (SDCM)  
Life: 50,000+ hrs, > 70% of initial lumens at 50,000 hrs

##### Electrical

Wattage: 6W/ft  
Electronic constant current LED driver, 48V input  
18AWG, 15 Amp

##### Drivers

DALI driver, 1% dimming  
0-10V driver, 1% dim

##### Finish

Powder coat paint, matte black or matte white

##### Mounting

A mechanical adapter allows for a quick and tool-less mounting to Amerlux's 48V track system, which saves times during installation and allows for easy reconfiguration

##### Certifications

cUL listed  
Indoor use only

##### Warranty

5 year limited warranty

#### Dots (Accent/Pendant Light Module)

##### Application

Hospitality and retail task lighting

##### Construction

Complete die-cast optical head construction  
No exposed wiring

##### Optical

Tilt: 0-90° (for accent head)  
Rotation: 360°+ (for accent head)  
Beam Spreads: A1/P1: Spot, 13°; Narrow Flood, 18°; Flood, 28°  
A2/P2: Spot, 15°; Narrow Flood, 22°; Medium Flood, 25°; flood, 28°; wide flood, 45°; very wide flood, 60°  
linear spread, 60° x 10°

##### LED

Color Temp Options\*: 2700K, 3000K, 3500K, 4000K  
CRI\*: 80 typ. or 90+ typ.  
R9 Values: A1/P1: 7 (80 CRI), 77 (90+ CRI)  
A2/P2: 55 (90+ CRI)  
Binning: 3 MacAdam (SDCM)  
Life: 50,000+ hrs, > 70% of initial lumens at 50,000 hrs

\* see ordering page for details

##### Electrical

Wattage: 7W (A1/P1), 16W (A2/P2)  
Electronic constant current LED driver, 48V input  
18AWG, 15 Amp

##### Drivers

DALI driver, 1% dimming  
0-10V driver, 1% dim

##### Finish

Powder coat paint, matte black or matte white

##### Mounting

A mechanical adapter allows for a quick and tool-less mounting to Amerlux's 48V track system, which saves times during installation and allows for easy reconfiguration

##### Certifications

CSA listed  
Indoor use only  
JA8/Title 24 Compliant (see ordering page for options that apply)

##### Warranty

5 year limited warranty

# Slots & Dots

48V Low Voltage Track, Deep Profile Pendant/Surface



PROJECT:

TYPE:

## SLOTS

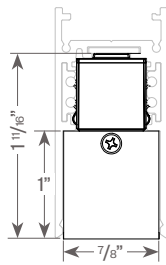

SD-TSD w/SLOT-xx

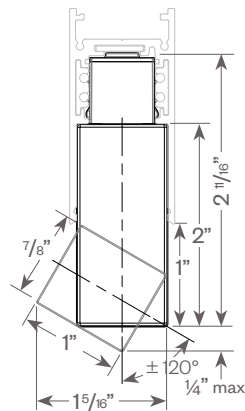

SD-TSD w/SLOT-ADJ-xx

1 FOOT NOMINAL

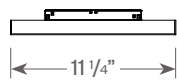

2 FOOT NOMINAL

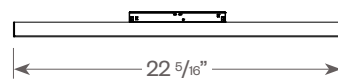

4 FOOT NOMINAL

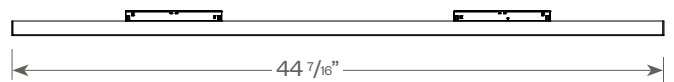

## SLOT - LENSES



Opal  
(SLOT-OP)



Microprismatic  
(SLOT-PR)



Comfort  
(SLOT-CO)



30°  
(SLOT-30)

## MINIMUM DISTANCE WITH LIVE END & L CONNECTOR

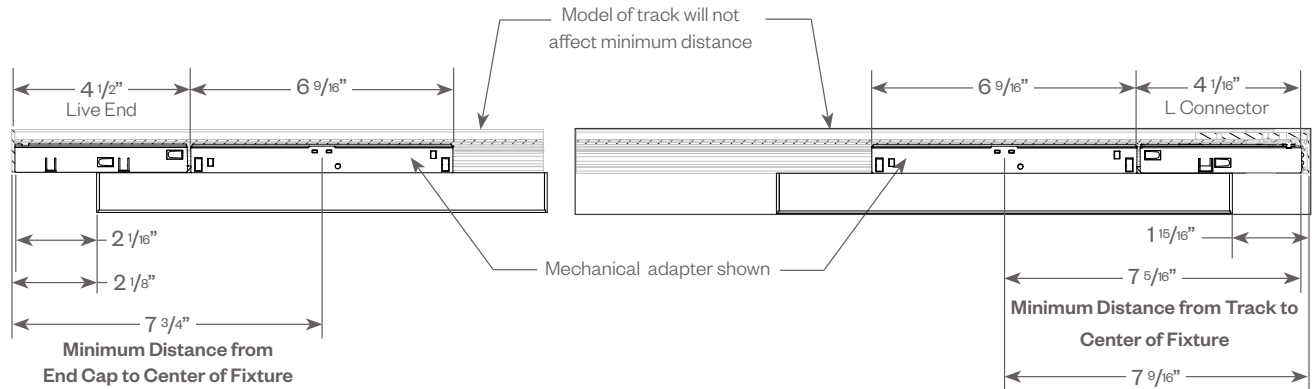



# Slots & Dots

48V Low Voltage Track, Deep Profile Pendant/Surface



**PROJECT:**

**TYPE:**

## DOTS WITH SD-TSD TRACK (SURFACE/PENDANT DEEP PROILE)

### DOT-A1D

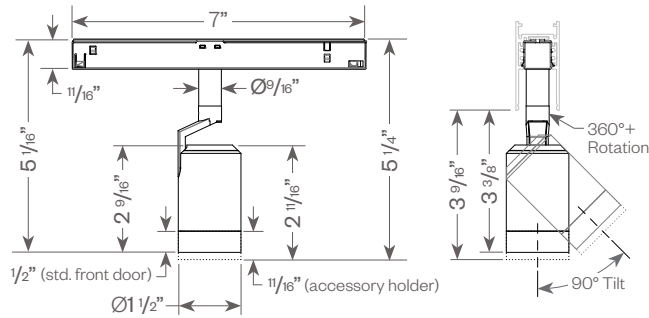

### DOT-A2D

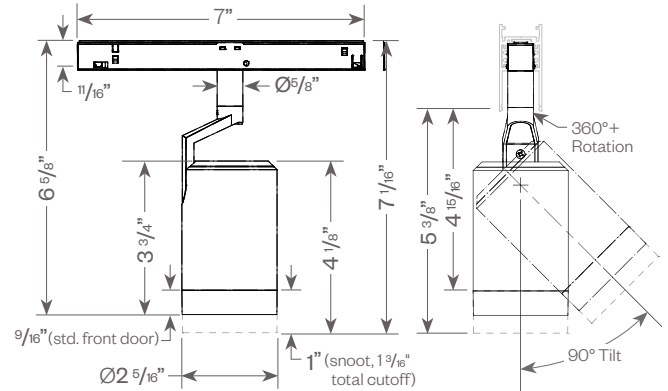

### DOT-P1

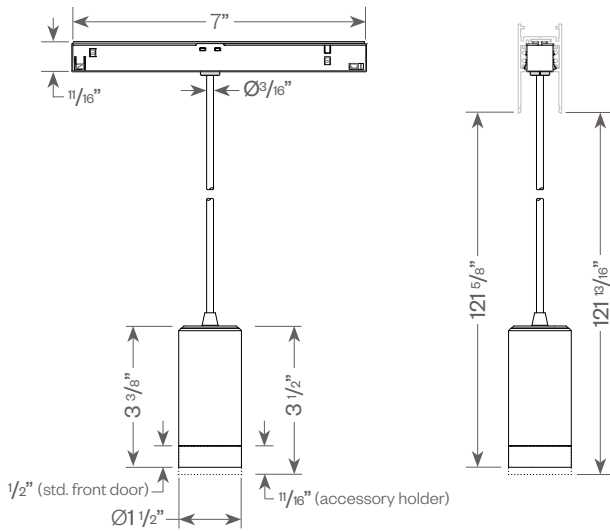

### DOT-P2

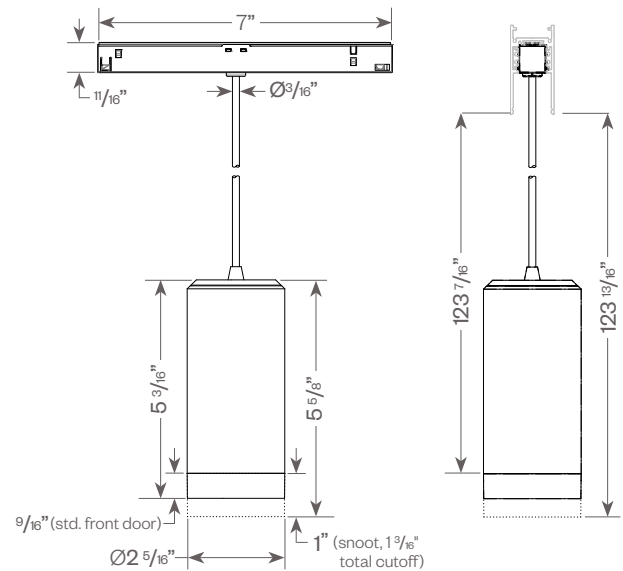

## MINIMUM DISTANCE WITH LIVE END & L CONNECTOR

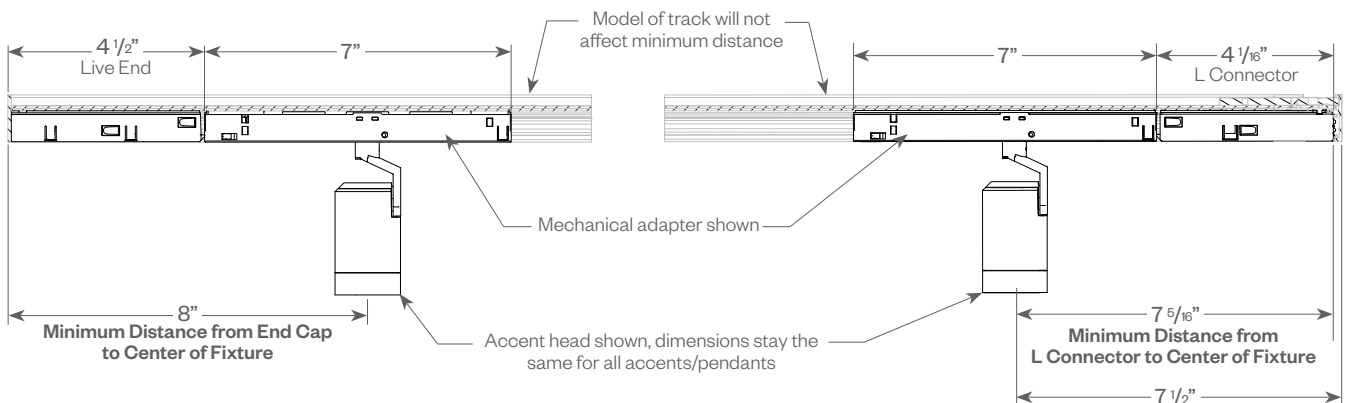

# Slots & Dots

48V Low Voltage Track, Deep Profile Pendant/Surface



**PROJECT:**

**TYPE:**

**FIXTURE DATA:** (Complete photometric data (.ies format) available upon request)

**MULTIPLYING FACTORS:** (Multiplying Factor is based on 3000K-90 120V IES file on website)

CCT:	2700K-90	3000K-90	3500K-90	4000K-90
Factor:	0.98	1.0	1.03	1.07

## SLOT-OP-1-309

Total Watts: 6  
Total Lumens: 490  
Lumens/Watt: 81.7

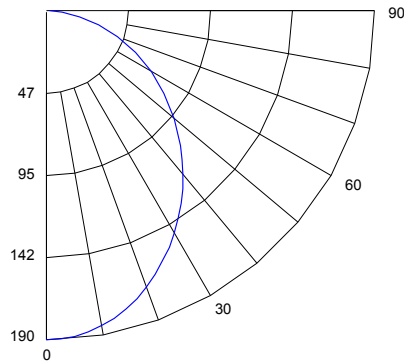

### ZONAL LUMEN SUMMARY

Zone	Lumens	%Fixt
0-40	228	46.6
0-60	390	79.7
0-90	490	100.0
0-180	490	100.0

**Total Luminaire Efficiency = 82%**

## SLOT-PR-1-309

Total Watts: 6  
Total Lumens: 343  
Lumens/Watt: 57.2

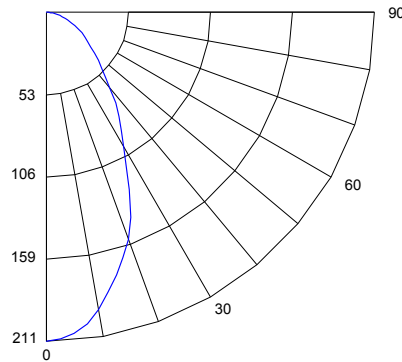

### ZONAL LUMEN SUMMARY

Zone	Lumens	%Fixt
0-40	60.8	17.7
0-60	301	87.5
0-90	342	99.7
0-180	343	100.0

**Total Luminaire Efficiency = 57%**

## SLOT-CO-1-309

Total Watts: 6  
Total Lumens: 511  
Lumens/Watt: 85.2

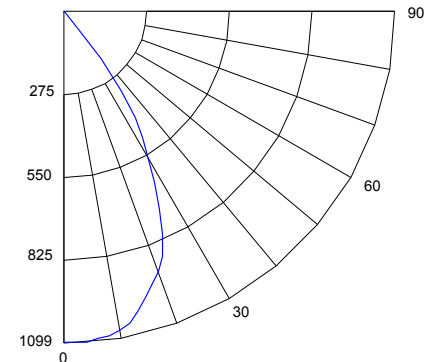

### ZONAL LUMEN SUMMARY

Zone	Lumens	%Fixt
0-40	488	95.5
0-60	511	99.9
0-90	511	100.0
0-180	511	100.0

**Luminaire Efficacy = 91%**

## SLOT-30-1-309

Total Watts: 6  
Total Lumens: 527  
Lumens/Watt: 87.8

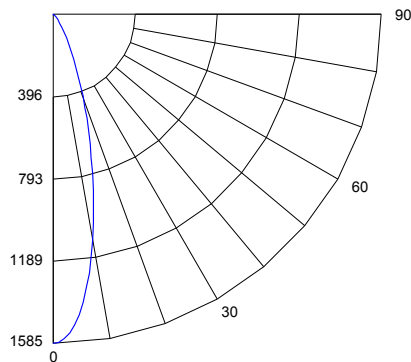

### ZONAL LUMEN SUMMARY

Zone	Lumens	%Fixt
0-40	492	93.3
0-60	523	99.2
0-90	527	99.7
0-180	527	100.0

**Luminaire Efficacy = 95%**

## SLOT-ADJ-26X42-1-309

Total Watts: 6  
Total Lumens: 474  
Lumens/Watt: 79

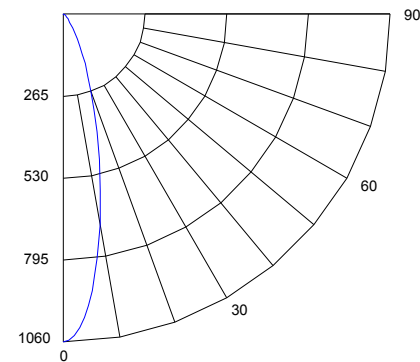

### ZONAL LUMEN SUMMARY

Zone	Lumens	%Fixt
0-40	428	90.4
0-60	468	98.7
0-90	474	100.0
0-180	474	100.0

**Luminaire Efficacy = 85%**

# Slots & Dots

48V Low Voltage Track, Deep Profile Pendant/Surface



**PROJECT:**

**TYPE:**

**FIXTURE DATA:** (Complete photometric data (.ies format) available upon request)

**MULTIPLYING FACTORS:** (Multiplying Factor is based on 3000K-90+ 120V IES file on website)

CCT:	3500K-80	4000K-80	2700K-90+	3000K-90+
Factor:	1.20	1.25	0.96	1.0

## 7W LED, 3000K-90+

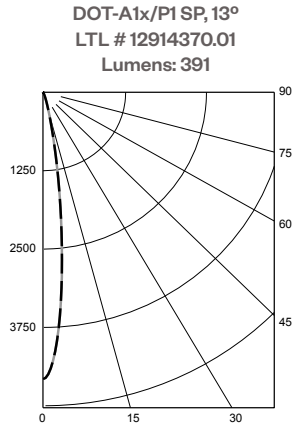

**Candelas at Nadir**

Deg	Candela
0	4573
5	3137
15	340
25	48
35	15
45	10

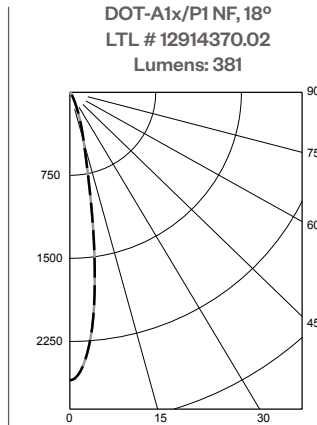

**Candelas at Nadir**

Deg	Candela
0	2601
5	2140
15	440
25	102
35	31
45	13

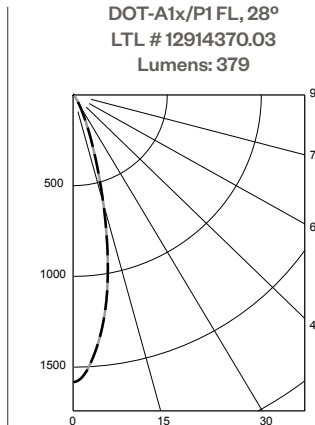

**Candelas at Nadir**

Deg	Candela
0	1583
5	1394
15	576
25	132
35	33
45	10

## APPLICATION DATA:

### Notes and Definitions:

Beam spread is to 50% center beam candlepower (CBCP).

**D**=Distance to floor or wall.

**FC**=Footcandles on floor or wall at center beam aiming location.

**L**=Effective Visual Beam length in feet (50% of maximum footcandle level).

**W**=Effective Visual Beam width in feet (50% of maximum footcandle level).

**CB**=Distance across or down to center beam location.

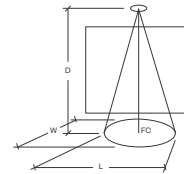

**0° Aiming Angle**  
**Horizontal**  
**Footcandles**

	0° Aiming Angle Horizontal Footcandles			
	D	FC	L	W
<b>Spot</b>	5.0'	102	1.6	1.6
	7.5'	60	2.2	2.2
	10.0'	38	2.8	2.8
	12.5'	26	3.3	3.3
<b>Narrow Flood</b>	5.0'	71	1.9	1.9
	7.5'	39	2.6	2.6
	10.0'	23	3.3	3.3
	12.5'	16	3.9	3.9
<b>Flood</b>	5.0'	50	2.5	2.5
	7.5'	25	3.4	3.4
	10.0'	15	4.5	4.5
	12.5'	10	5.5	5.5

# Slots & Dots

48V Low Voltage Track, Deep Profile Pendant/Surface



**PROJECT:**

**TYPE:**

**FIXTURE DATA:** (Complete photometric data (.ies format) available upon request)

**MULTIPLYING FACTORS:** (Multiplying Factor is based on 3000K-90+ 120V IES file on website)

CCT:	2200K-90	2700K-90	3000K-90	3500K-90+	4000K-90+	CRISP	3CLA
Factor:	0.86	0.96	1.0	1.05	1.08	0.76	0.90

**16W LED, 3000K-90+**

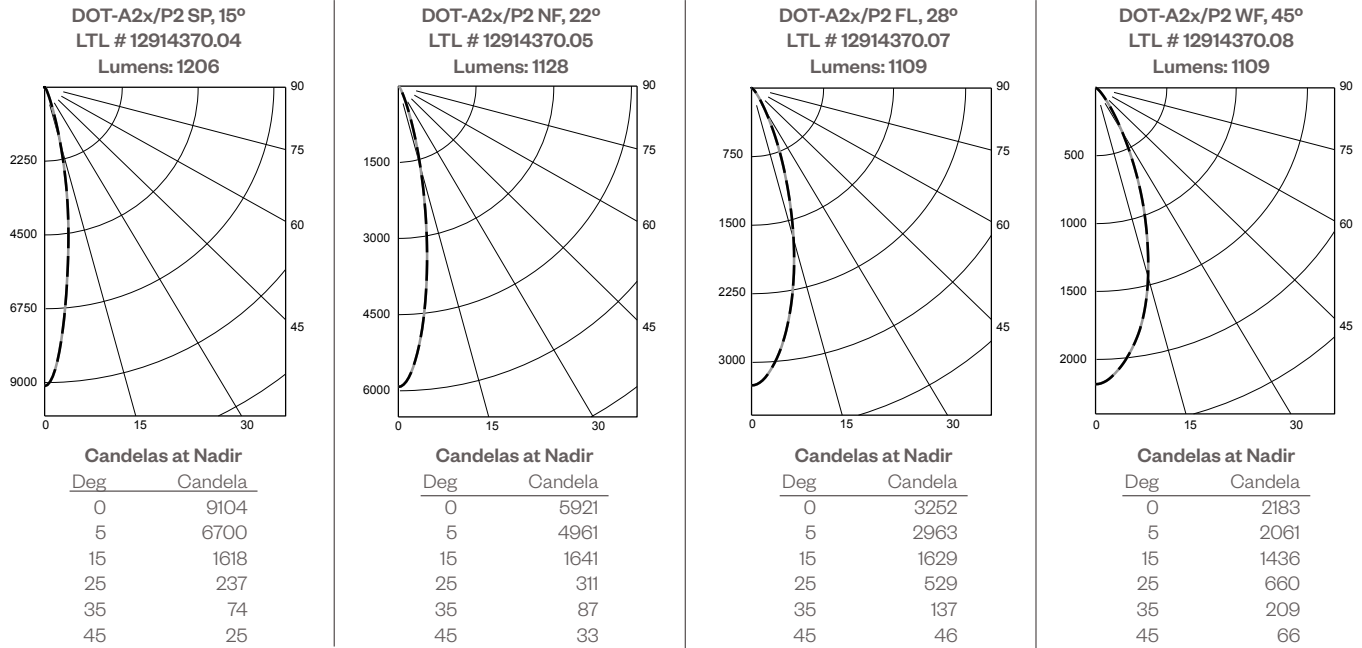

**APPLICATION DATA:**

**Notes and Definitions:**

- Beam spread is to 50% center beam candlepower (CBCP).
- D**=Distance to floor or wall.
- FC**=Footcandles on floor or wall at center beam aiming location.
- L**=Effective Visual Beam length in feet (50% of maximum footcandle level).
- W**=Effective Visual Beam width in feet (50% of maximum footcandle level).
- CB**=Distance across or down to center beam location.

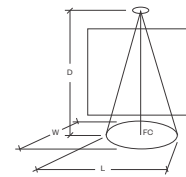

**0° Aiming Angle  
Horizontal  
Footcandles**

	D	FC	L	W
<b>Spot</b>	5.0'	232	2.0	2.0
	7.5'	126	2.7	2.7
	10.0'	77	3.3	3.3
	12.5'	52	4.0	4.0
<b>Narrow Flood</b>	5.0'	174	2.3	2.3
	7.5'	90	3.1	3.1
	10.0'	54	3.9	3.9
	12.5'	35	4.8	4.8
<b>Flood</b>	5.0'	109	2.9	2.9
	7.5'	53	3.9	3.9
	10.0'	31	5.2	5.2
	12.5'	20	6.5	6.5
<b>Wide Flood</b>	5.0'	77	3.4	3.4
	7.5'	37	4.9	4.9
	10.0'	21	6.5	6.5
	12.5'	14	8.0	8.0

# Slots & Dots

48V Low Voltage Track, Deep Profile Pendant/Surface



Slots & Dots - 48V LVT-Deep Profile P/S

**PROJECT:**

**TYPE:**

## TSD TRACK BREAKDOWN

### NOTES:

1. Junction Box not included for canopy mounting
2. 48V Transformer is remote mounted no further than 30'. Wires from transformer to J-Box are to be 16 ga.

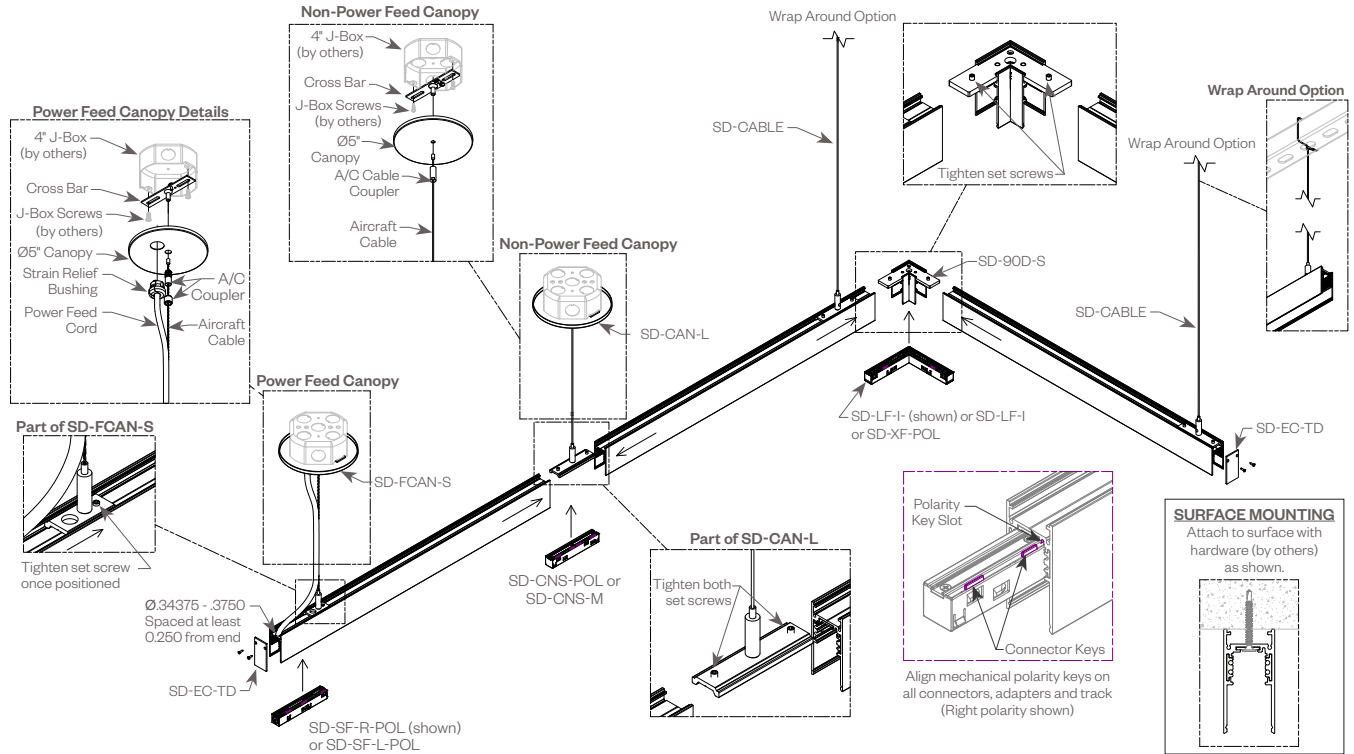

## END FEED WIRING

### Left End Feed

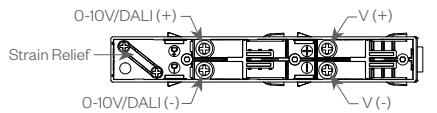

### Right End Feed

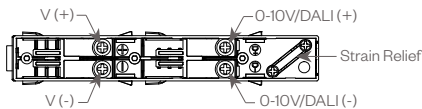

### Wire Details

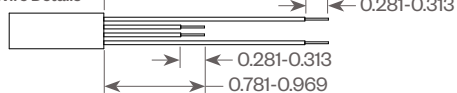

## PENDANT WIRING

Note: Refer to Wired Control wiring schematics, pg 14.

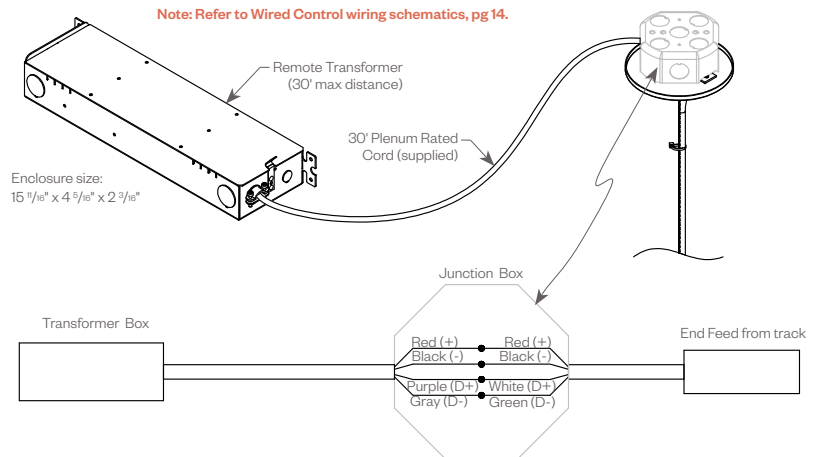

## VOLTAGE DROP

Maximum allowed track length for a 30' plenum rated cable supplied by Amerlux according to the selected wattages.

Power Supply (W)/	Max.Track Length (ft)
100W	750
260W	200
320W	150

Voltage drop approximately 12.5%, 6V

**Note: Ensure that the transformer does not exceed 80% of the total wattage in order to maintain its optimal performance.**

# Slots & Dots

48V Low Voltage Track, Deep Profile Pendant/Surface



## PROJECT:

## TYPE:

### DIMMING COMPATIBILITY:

Amerlux® Slots & Dots 48V system is compatible with DALI system. Please see below for wiring diagrams. Amerlux recommends testing your unique dimming configuration as the exact full configuration (Dimmer, Fixture Quantity, Voltage, etc) may affect dimming performance.

### WIRED CONTROL - DALI

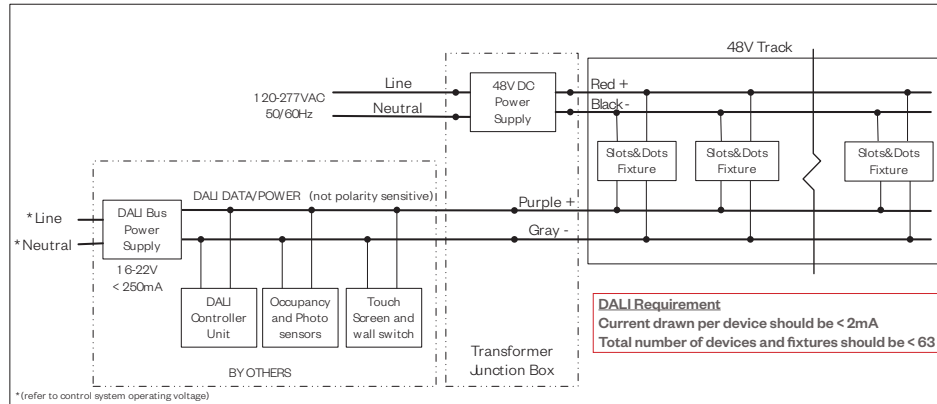

### SUGGESTED SWITCHES FOR WIRED CONNECTION

Manufacturer	Model	
Loytec DALI PSU	L-DALI-PWR2-U	DALI Bus Power Supply, 85-240VAC input, 2 channel DALI PSU, 116 mA per channel
Loytec Controller	L-DALI-ME204-U	DALI Controller, 4 channel DALI
Loytec Controller	L-DALI-ME201-U	DALI Controller, 1 DALI channel with integrated DALI power supply
B.E.G	PP-DALI-PS	DALI Bus Power Supply, 120-277VAC input, 100 mA bus power

### WIRED CONTROL - 0-10V

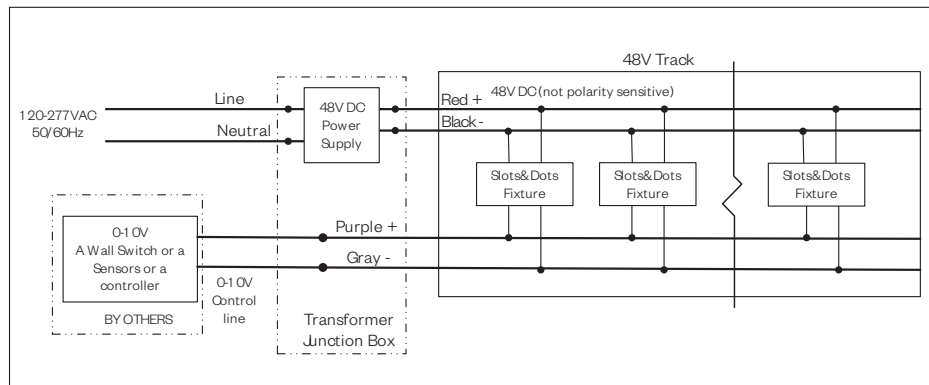

#### Notes:

- 120V or 277V\*
- Dims down to 1% light output
- Requires interface to turn off power to driver
- Consult Dimming manufacturer for installation instructions - DO NOT SHARE NEUTRALS!

#### Compatible Dimmers†:

##### Wall Box

Lutron "Diva" - DTV with PP-120H Interface  
Leviton Renoir II 0-10V

##### Central System

Lutron Grafik Eye with GRX-TVI Interface

#### Notes:

- \* Driver is 277V dimmable with appropriate dimmer (by others). All provided wiring diagrams show 120V wiring colors and method. Please refer to 277V dimmer installation instructions for 277V wiring diagrams.
- † The absence of a dimmer from the lists above does not imply incompatibility. Please consult factory for compatibility inquiries.