

Hornet® HP

Surface Canopy



Features

The brand new Hornet® HP LED replaces the 20W ceramic metal halide fixture you've grown to love. Small and compact, the Hornet HP delivers the power of the 20W CMH, but surpasses it with enhanced control, instant on, dimmability and long lifespan. Available in surface canopy mount, the Hornet-HP-SC's quality, energy efficient light source provides better maintained and more secure lumens, and consistent color rendering.

Product Overview

Type:	Track Accent & Display
Wattage:	11, 16, 18, 20
Lumen Output:	1,785 max; 88.3 lm/W (spot optic)
CBCP:	14,280 max (spot optic)
Color Temp:	2200K, 2700K, 3000K, 3500K, 4000K
CRI:	83 typ. (2700K, 3000K, 3500K, 4000K) 90+ typ. (2200K, 2700K, 3000K, 3500K, 4000K) CrispWhite & Class A LED's available
Dimming:	TRIAC & ELV (120/277VAC) - 5% Dim

PROJECT:

TYPE:

Fixture Summary *(see following pages for more information)*

Performance Chart

Watts	Delivered Lumens	LPW	CBCP	Color Temp
11	1030	93.7	8,243	3000K-83
16	1451	102.2	11,610	3000K-83
18	1640	96.4	13,119	3000K-83
20	1785	88.3	14,280	3000K-83

*Data is based on Spot optic
See pg 5 for other beam spreads*

Electrical Data

	11W		16W		18W		20W	
	System Watts	Amps	System Watts	Amps	System Watts	Amps	System Watts	Amps
120V	11	0.09	14.2	0.12	17	0.14	20.2	0.17
277V	11	0.04	14.2	0.05	17	0.06	20.2	0.07

Electronic constant current LED driver



Hornet® HP

Surface Canopy



PROJECT:

TYPE:

Ordering Information



1 Model
HORNET-HP-SC

2 Wattage
11
16
18
20

3 Finish
WT - white texture
BT - black texture
ST - silver texture
Other finishes, consult factory

4 Voltage
120-277

5 Beam Spreads
SP - spot, 15°
NF - narrow flood, 22°
MFL - medium flood, 25°
FL - flood, 28°
WF - wide flood, 40°
VWF - very wide flood, 60°
LS - linear spread, 60° x 10°

6 Color Temp
83 CRI: **90+ CRI:**
27 - 2700K-83 **229[†]** - 2200K-90+ **CRISP[†]** - CrispWhite
30 - 3000K-83 **279** - 2700K-90+ **3CLA[†]** - 3K Class A
35 - 3500K-83 **309** - 3000K-90+
40 - 4000K-83 **359** - 3500K-90+
 409 - 4000K-90+

[†] Not available for 18W or 20W

7 Driver
LE/TE - TRIAC/ELV dimming

8 Options/Accessories
SNAH - snoot accessory holder, 1" length, matte black interior, exterior finish matches fixture finish, accepts cross blade plus 2 additional forms of media
AH - accessory holder, finish matches fixture finish, accepts 2 forms of media
HEX - hexcell louver, 1/8" x 1/8" (requires SNAH or AH)
SOL - solite lens (requires SNAH or AH)
CB - cross blade, matte black finish (requires SNAH)

Hornet[®] HP

Surface Canopy



PROJECT:

TYPE:

Specifications

Application

Retail and Commercial accent and display lighting

Construction

Complete die-cast construction
No exposed wiring

Optical

0-180° tilt, 360° rotation
Beam spreads: Spot, 15°; Narrow Flood, 22°;
Medium Flood, 25°; Flood, 28°; Wide Flood, 40°;
Very Wide Flood, 60°; Linear Spread, 60° x 10°

LED

Color Temp Options:

2200K, 2700K, 3000K, 3500K, 4000K

CRI: 83 typ. (2700K, 3000K, 3500K, 4000K)

90+ typ. (2200K, 2700K, 3000K, 3500K, 4000K)

CrispWhite* LED available, 16W max

Class A** 3000K (high CRI, high gamut)

R9 Values: 11 (83 CRI), 55 (90+ CRI)

Binning: 3-step MacAdam ellipse (SDMC)

Life: 50,000+ hrs, > 70% of initial lumens at 50,000 hrs

**CrispWhite: CrispWhite Technology delivers the warmth of colors expected from a high 90 CRI solution but also creates the natural crisp white color that is pleasing to the eye. It creates the most impactful lighting ever available, by revealing the richest whites and vibrant colors that pop.*

***Class A LED: Class A LED's have a CRI > 80 and a GAI > 80. CRI defines color "Naturalness" and GAI defines color "Saturation." Both being high delivers rich colors and pure whites.*

Electrical

Wattage: 11, 16, 18, 20

Electronic constant current LED driver, 120/277VAC input
This product complies with IEEE C62.41 for surge endurance up to 2.5KV. Amerlux® recommends using additional surge protection with this unit (supplied by others), surge and over voltage damage is not covered under warranty.

Driver

LE/TE - Leading Edge (Triac, Forward Phase) or Trailing Edge (ELV, Reverse Phase) autosensing driver dims down to 5% on most dimming systems.

See dimming pages for more information.

Finish

Powder coat paint.

Standard colors: White Texture, Black Texture, Silver Texture

Consult factory for custom RAL powder coat finishes

Mounting

Surface canopy mounting

Certifications

Approved to UL standards as tested by CSA.
Intended for indoor use only.

Warranty

5 year limited warranty

Hornet[®] HP

Surface Canopy



PROJECT:

TYPE:

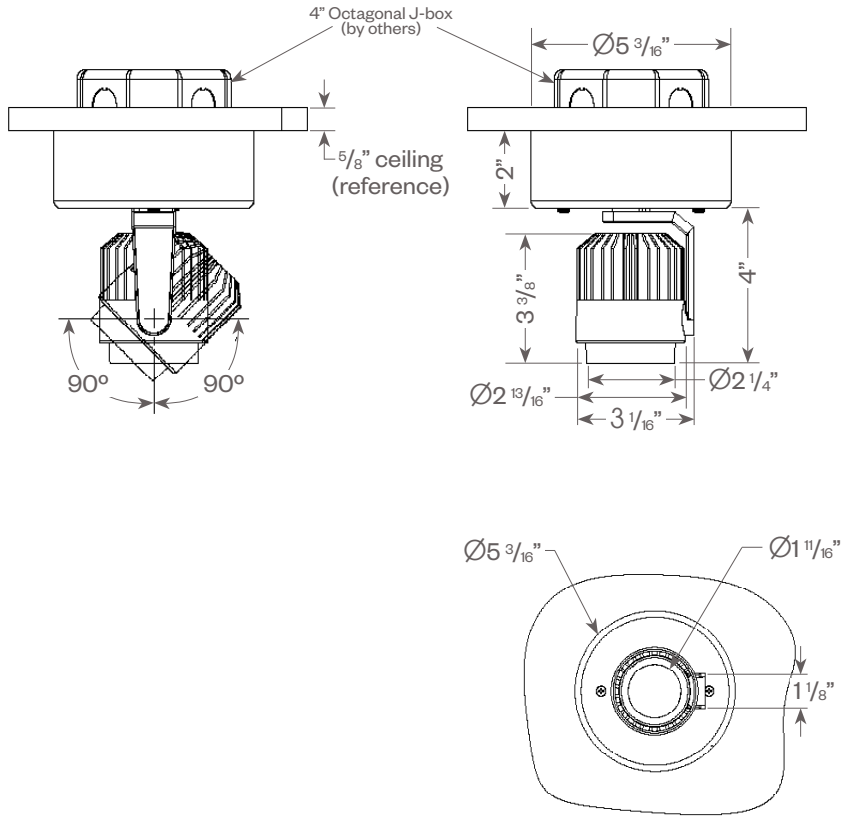

Accessories

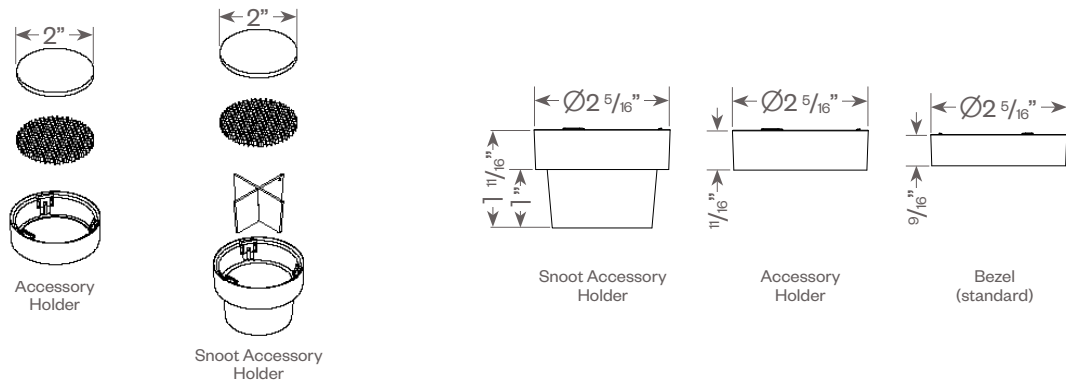

Hornet[®] HP

Surface Canopy



PROJECT:

TYPE:

FIXTURE DATA: (Complete photometric data (.ies format) available upon request)

MULTIPLYING FACTORS: (Multiplying Factor is based on 3000K-83 120V IES file on website)

Wattage:	11W	16W	18W	20W
Factor:	0.71	1.0	1.13	1.23

CCT:	2700K-83	3000K-83	3500K-83	4000K-83
Factor:	0.96	1.0	1.02	1.04

CCT:	2200K-90+*	2700K-90+	3000K-90+	3500K-90+	4000K-90+	CRISP*	3CLA*
Factor:	0.71	0.80	0.83	0.87	0.90	0.65	0.75

* Not available for use with 18W or 20W

16W, 3000K-83

Spot (SP) Distribution, 15°
LTL #14346087.01
Lumens: 1,451

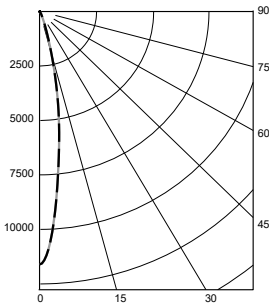

Candelas at Nadir

Deg	Candela
0	11610
5	8378
15	1825
25	257
35	86
45	31

Narrow Flood (NF) Distribution, 22°
LTL #14346087.02
Lumens: 1,390

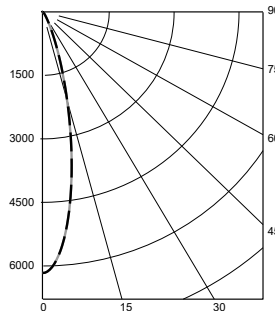

Candelas at Nadir

Deg	Candela
0	6167
5	5391
15	2012
25	426
35	119
45	52

Flood (FL) Distribution, 28°
LTL #14346087.04
Lumens: 1,370

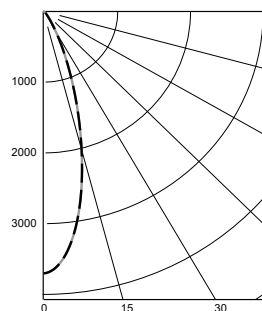

Candelas at Nadir

Deg	Candela
0	3703
5	3440
15	1925
25	651
35	179
45	67

Wide Flood (WF) Distribution, 40°
LTL #14346087.05
Lumens: 1,374

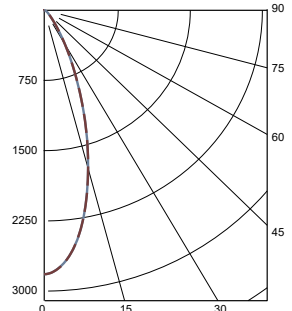

Candelas at Nadir

Deg	Candela
0	2820
5	2674
15	1750
25	763
35	248
45	86

Application Data:

Notes and Definitions:

- Beam spread is to 50% center beam candlepower (CBCP).
- D=Distance to floor or wall.
- FC=Footcandles on floor or wall at center beam aiming location.
- L=Effective Visual Beam length in feet (50% of maximum footcandle level).
- W=Effective Visual Beam width in feet (50% of maximum footcandle level).
- CB=Distance across or down to center beam location.

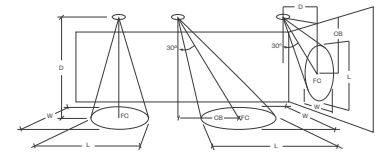

	0° Aiming Angle Horizontal Footcandles				30° Aiming Angle Horizontal Footcandles					30° Aiming Angle Vertical Footcandles					60° Aiming Angle Vertical Footcandles				
	D	FC	L	W	D	FC	L	W	CB	D	FC	L	W	CB	D	FC	L	W	CB
Spot	5.0'	463	1.4	1.4	5.0'	213	2.3	2.2	3.0	3.0'	135	3.4	2.2	5.0	3.0'	403	1.8	1.6	2.0
	7.5'	206	2.1	2.1	7.5'	110	3.3	2.9	4.0	4.0'	87	4.2	2.6	6.0	4.0'	295	2.1	1.8	2.0
	10.0'	116	2.9	2.9	10.0'	64	4.3	3.7	5.0	5.0'	58	5.2	3.2	8.0	5.0'	205	2.5	2.2	3.0
	12.5'	74	3.6	3.6	12.5'	44	5.1	4.5	7.0	6.0'	42	6.2	3.6	9.0	6.0'	162	2.8	2.5	3.0
Narrow Flood	5.0'	247	1.9	1.9	5.0'	133	2.9	2.7	3.0	3.0'	97	3.7	2.4	4.0	3.0'	280	2.1	1.8	2.0
	7.5'	110	3.0	3.0	7.5'	67	4.0	3.6	4.0	4.0'	57	4.8	3.1	5.0	4.0'	201	2.4	2.2	2.0
	10.0'	62	3.9	3.9	10.0'	40	5.2	4.6	5.0	5.0'	39	5.7	3.6	7.0	5.0'	131	3.0	2.7	3.0
	12.5'	40	5.0	5.0	12.5'	26	6.4	5.7	6.0	6.0'	28	6.9	4.3	8.0	6.0'	99	3.4	3.0	3.0
Flood	5.0'	168	2.5	2.5	5.0'	86	3.6	3.2	2.0	3.0'	70	3.9	2.9	4.0	3.0'	194	2.4	2.2	2.0
	7.5'	72	3.7	3.7	7.5'	42	5.0	4.6	4.0	4.0'	43	5.1	3.5	5.0	4.0'	138	2.8	2.7	2.0
	10.0'	40	5.0	5.0	10.0'	25	6.5	5.9	5.0	5.0'	28	6.2	4.4	6.0	5.0'	87	3.6	3.2	2.0
	12.5'	25	6.3	6.3	12.5'	16	8.2	7.4	6.0	6.0'	20	7.5	5.2	7.0	6.0'	65	4.0	3.7	3.0
Wide Flood	5.0'	113	3.0	3.0	5.0'	71	3.9	3.5	2.0	3.0'	60	4.1	3.1	3.0	3.0'	156	2.7	2.5	2.0
	7.5'	50	4.5	4.5	7.5'	34	5.5	5.1	3.0	4.0'	36	5.3	3.9	4.0	4.0'	110	3.1	3.0	2.0
	10.0'	28	6.0	6.0	10.0'	19	7.4	6.8	5.0	5.0'	24	6.4	4.8	5.0	5.0'	72	3.9	3.5	2.0
	12.5'	18	7.5	7.5	12.5'	13	9.1	8.4	6.0	6.0'	17	7.7	5.7	7.0	6.0'	52	4.5	4.2	3.0

PROJECT:

TYPE:

DIMMING COMPATIBILITY:

Amerlux® Hornet® fixtures are compatible with all major dimming protocols prevalent in the United States. Please see below for general compatibilities and wiring diagrams. Amerlux recommends testing your unique dimming configuration as the exact full configuration (Dimmer, Fixture Quantity, Voltage, etc) may affect dimming performance.

--- NOTE: INFORMATION BELOW IS FOR WIRED DIMMERS ONLY. FOR WIRELESS DIMMERS, CONSULT FACTORY ---

TRIAC (Forward Phase) DIMMING (Standard)

Utilizes standard TRIAC dimmers that are in wide use in installations across the US. Best for retrofit applications where TRIAC dimmers are installed.

Notes:

- 120VAC or 277VAC*
- Dims down to 5% light output (most cases)
- Consult Dimming manufacturer for installation instructions - DO NOT SHARE NEUTRALS!
- Must meet dimmer Minimum Load Requirements per dimming manufacturer

TRIAC Wiring Diagram

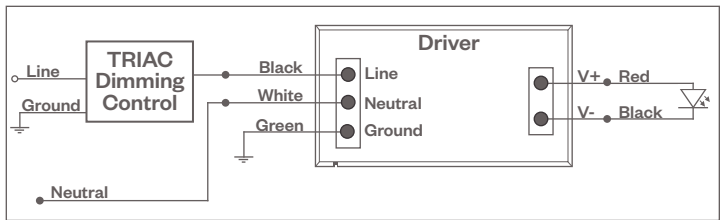

Compatible Dimmers†:

Wall Box (TRIAC 120VAC)	Central System
Lutron "Diva"	Lutron "GP" Panel
Lutron "Nova-T"	Lutron Grafik Eye QS
Lutron "Maestro"	
Lutron "Skylark"	

ELV - Electronic Low Voltage (Reverse Phase) DIMMING (Standard)

Utilizes specialized "ELV" dimmers.

Notes:

- 120VAC or 277VAC*
- Dims down to 5% light output (most cases)
- Consult Dimming manufacturer for installation instructions - DO NOT SHARE NEUTRALS!
- Must meet dimmer Minimum Load Requirements

ELV Wiring Diagram

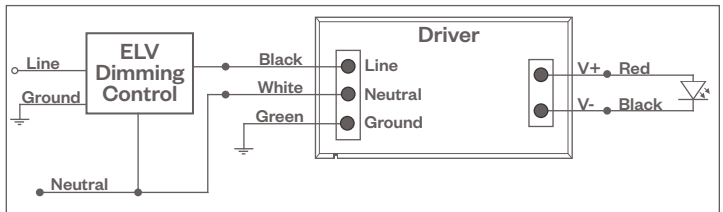

Compatible Dimmers†:

Wall Box (ELV 120VAC)	Wall Box (ELV 277VAC)	Central System
Lutron "Diva"	Leviton Revoir II AWSMT-E	Lutron "GP" Panel with PHPM-PA 120/277VAC
Lutron "Nova-T"		Lutron Grafik Eye QS with PHPM-PA 120/277VAC
Lutron "Maestro"		
Lutron "Skylark"		
Leviton "Surslide"		
Leviton "Vizio"		

Notes:

- * Driver is 277VAC dimmable with appropriate dimmer (by others). All provided wiring diagrams show 120VAC wiring colors and method. Please refer to 277VAC dimmer manufacturer installation instructions for 277VAC wiring diagrams.
- † The absence of a dimmer from the lists above does not imply incompatibility. Please consult factory for compatibility inquiries.