

# CYLINDRIX® III MINI

INTERNATIONAL MULTIPLE RECESSED 4 LIGHT TRIMLESS LED

I-C3MRTLX-4  
4LT LED

## APPLICATION:

Accent and display lighting for retail, commercial and hospitality environments

## CONSTRUCTION:

Stamped steel mounting frame  
Steel plaster frame  
Steel driver housing  
Extruded aluminum upper housing with knife-edge and mitered/welded corners  
Complete die-cast optical head construction  
No exposed wiring  
Powder coat paint

## ELECTRICAL:

Electronic constant current LED driver, 240v input  
ELV and Triac dimming standard.  
0-10v and DALI systems also available.

**This product complies with IEEE C62.41 for surge endurance up to 2.5KV. Amerlux® recommends using additional surge protection with this unit (supplied by others), surge damage is not covered by warranty.**

## OPTICS:

0-30° x 40° tilt, 360°+ rotation  
Available in a variety of beam spreads  
LED:  
Color Temp Options: 2200K, 2700K, 3000K, 3500K, 4000K  
CRI: 83 typ. (2700K, 3000K, 3500K, 4000K)  
90+ typ. (2200K, 2700K, 3000K, 3500K)  
CrispWhite & Class A LED available  
R9 Values: 11 (83CRI), 55 (92CRI)  
Binning: 3 MacAdam  
Lumen Maintenance: >70% of initial lumens @ 50,000 hrs  
Lumen Output (21W, 3000K): 1850 lm (89.6 lpw)  
CBCP (21Ww, 3000K): SP 13,578  
VNSP (18W only) 24,308

## MOUNTING:

Swing out lugs permit from below mounting into ceiling up 55 mm thick

## LABELING:

**CE**  
For indoor use only



## PROJECT:

TYPE:

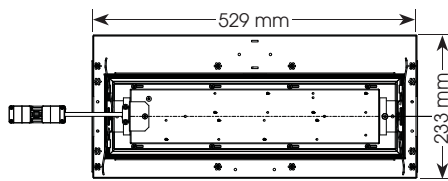

Ceiling Cut Out Dimension: 141 mm x 491 mm

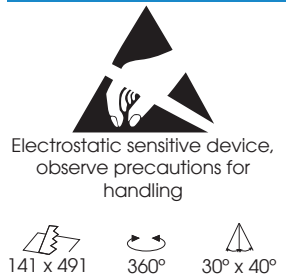
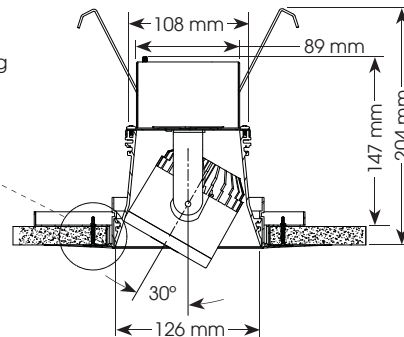
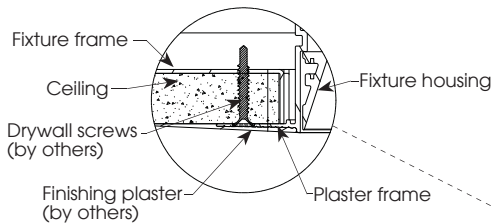
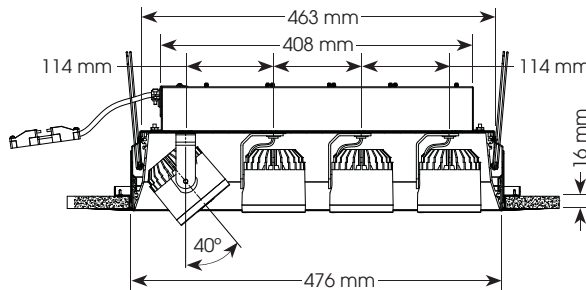

## ELECTRICAL

Electronic driver

240v	4x15W		4x18W		4x21W	
	System Watts	Amps	System Watts	Amps	System Watts	Amps
	60	0.24	72	0.32	84	0.36

## ORDERING INFORMATION:

Model	# Heads	Wattage	Lamp Type	Housing/Head Finish	Voltage	Beam Spreads*				Color Temp (CCT-CRI)	Listing	Options/Accessories
						Head 1	Head 2	Head 3	Head 4			
I-C3MRTLX	4	15	LED	WT - white texture	240	SP	SP	SP	SP	27 - 2700-83	CE	SN- snoot, 1" w/matte black interior standard HEX - hexcell louver LS - linear spread CB - cross blade, matte black, requires snoot SOL - solite beam softening lens 0-10V - 0-10v dimming DALI - DALI driver
						VNF	VNF	VNF	VNF	30 - 3000-83		
		NF				NF	NF	NF	35 - 3500-83			
		FL				FL	FL	FL	40 - 4000-83			
		WF				WF	WF	WF	229 - 2200-90+			
						279 - 2700-90+						
						VNSP** VNSP** VNSP** VNSP**	309 - 3000-90+					
						** (18w only)	359 - 3500-90+					
							3CLA - 3K Class A					
							CRISP - CrispWhite					

\*SP - spot 14°, VNF - very narrow flood 18°, NF - narrow flood 23°, FL - flood 34°, WF - wide flood 44°, VNSP - very narrow spot 8°

Example: I-C3MRTLX-4-21-LED-WT-240-SP-SP-SP-SP-30-CE

Cat #:

Amerlux reserves the right to change details that do not affect overall function and performance.



**3** year limited warranty  
AMERLUX INTERNATIONAL  
(see website for details)

# CYLINDRIX® III MINI

INTERNATIONAL MULTIPLE RECESSED 4 LIGHT TRIMLESS LED

I-C3MRTLX-4  
4LT LED



TYPE:



**FIXTURE DATA:** For 15W data, multiply by 0.71; For 18W data see next page

Complete photometric data (ies format) available upon request.

CCT Correction Factors: 2700-83 = 0.96; 3500-83 = 1.02; 4000-83 = 1.04; 2200-90+ = 0.71; 2700-90+ = 0.80; 3000-90+ = 0.83; 3500-90+ = 0.87; Crisp = 0.65

**21W LED (3000K-83) Note: Data per head**

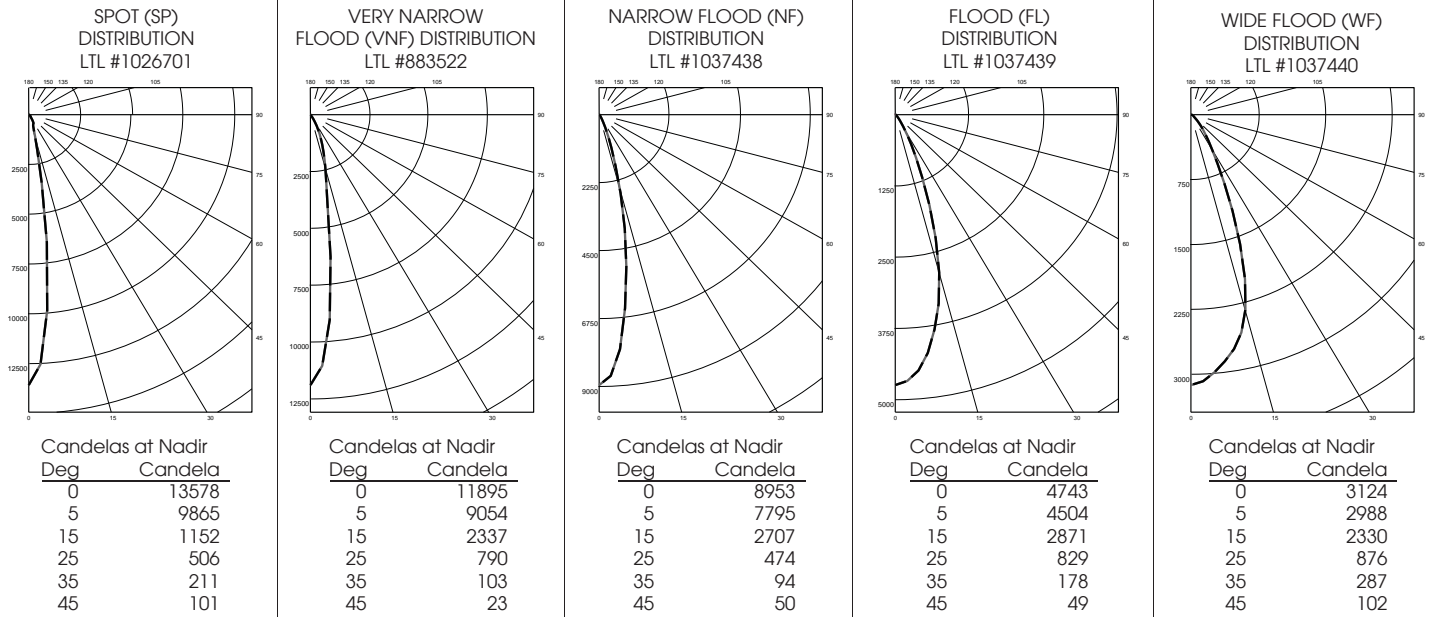

**APPLICATION DATA:**

**Notes and Definitions:**

Beam spread is to 50% center beam candlepower (CBCP).  
 D=Distance to floor or wall.  
 FC=Footcandles on floor or wall at center beam aiming location.  
 L=Effective Visual Beam length in feet (50% of maximum footcandle level).  
 W=Effective Visual Beam width in feet (50% of maximum footcandle level).  
 CB=Distance across or down to center beam location.

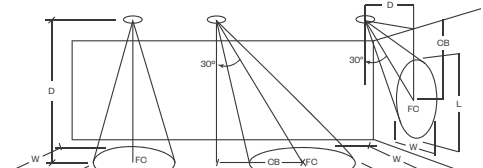

	0° Aiming Angle Horizontal Footcandles				30° Aiming Angle Horizontal Footcandles				30° Aiming Angle Vertical Footcandles				60° Aiming Angle Vertical Footcandles						
	D	FC	L	W	D	FC	L	W	CB	D	FC	L	W	CB	D	FC	L	W	CB
SPOT	5.0'	540	1.2	1.2	5.0'	348	1.6	1.4	3.0	3.0'	200	2.8	1.4	5.0	3.0'	726	1.3	1.1	2.0
	7.5'	241	1.8	1.8	7.5'	155	2.5	2.2	4.0	4.0'	121	3.5	1.8	6.0	4.0'	518	1.5	1.2	2.0
	10.0'	136	2.6	2.6	10.0'	85	3.4	3.0	6.0	5.0'	77	4.3	2.5	8.0	5.0'	334	1.8	1.3	3.0
	12.5'	87	3.2	3.2	12.5'	57	4.2	3.6	7.0	6.0'	54	5.2	2.9	9.0	6.0'	230	2.2	1.6	3.0
VERY NARROW FLOOD	5.0'	473	1.4	1.4	5.0'	305	1.9	1.5	3.0	3.0'	176	3.4	1.5	5.0	3.0'	651	1.6	1.2	2.0
	7.5'	211	2.1	2.1	7.5'	136	2.9	2.5	4.0	4.0'	108	4.1	2.0	6.0	4.0'	462	1.6	1.3	2.0
	10.0'	119	2.9	2.9	10.0'	75	3.8	3.3	6.0	5.0'	67	5.3	2.8	8.0	5.0'	293	2.0	1.5	3.0
	12.5'	76	3.5	3.5	12.5'	50	4.7	3.9	7.0	6.0'	49	6.3	3.2	9.0	6.0'	206	2.4	1.8	3.0
NARROW FLOOD	5.0'	358	1.9	1.9	5.0'	257	2.4	2.1	3.0	3.0'	181	3.2	1.8	4.0	3.0'	620	1.9	1.2	2.0
	7.5'	159	2.9	2.9	7.5'	115	3.5	3.2	4.0	4.0'	96	4.4	2.8	6.0	4.0'	426	1.9	1.5	2.0
	10.0'	90	3.8	3.8	10.0'	63	4.8	4.2	5.0	5.0'	63	5.3	3.3	7.0	5.0'	249	2.5	2.2	3.0
	12.5'	58	4.8	4.8	12.5'	40	6.1	5.4	7.0	6.0'	43	6.7	4.0	8.0	6.0'	182	2.9	2.6	3.0
FLOOD	5.0'	190	2.9	2.9	5.0'	130	3.5	3.1	2.0	3.0'	113	3.4	2.7	3.0	3.0'	340	2.3	1.8	1.0
	7.5'	85	4.3	4.3	7.5'	58	5.2	4.8	3.0	4.0'	64	4.6	3.5	4.0	4.0'	208	2.8	2.6	2.0
	10.0'	48	5.7	5.7	10.0'	34	6.8	6.4	5.0	5.0'	41	5.8	4.4	5.0	5.0'	133	3.5	3.1	2.0
	12.5'	31	7.2	7.2	12.5'	22	8.5	8.0	6.0	6.0'	29	7.0	5.2	7.0	6.0'	93	4.1	3.8	3.0
WIDE FLOOD	5.0'	125	3.3	3.3	5.0'	92	3.9	3.5	2.0	3.0'	92	3.2	2.7	3.0	3.0'	254	2.3	2.0	1.0
	7.5'	56	5.0	5.0	7.5'	41	5.6	5.4	3.0	4.0'	52	4.3	3.6	4.0	4.0'	138	3.2	3.0	2.0
	10.0'	32	6.7	6.7	10.0'	23	7.6	7.3	4.0	5.0'	34	5.3	4.6	5.0	5.0'	93	3.9	3.5	2.0
	12.5'	20	8.5	8.5	12.5'	15	9.6	9.2	5.0	6.0'	23	6.5	5.5	6.0	6.0'	64	4.7	4.5	2.0

# CYLINDRIX® III MINI

INTERNATIONAL MULTIPLE RECESSED 4 LIGHT TRIMLESS LED

I-C3MRTLX-4  
4LT LED



TYPE:



**FIXTURE DATA:** For 15W data, multiply by 0.71

Complete photometric data (ies format) available upon request.

CCT Correction Factors: 2700-83 = 0.96; 3500-83 = 1.02; 4000-83 = 1.04; 2200-90+ = 0.71; 2700-90+ = 0.80; 3000-90+ = 0.83; 3500-90+ = 0.87; Crisp = 0.65

**18W LED (3000K-83) Note: Data per head**

VERY NARROW SPOT (VNSP)  
DISTRIBUTION  
LTL #1170140

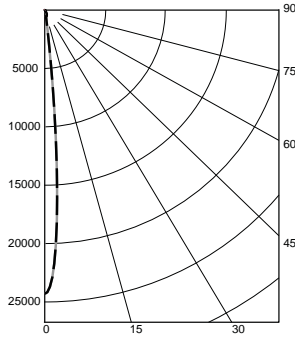

Candelas at Nadir	Deg	Candela
	0	24308
	5	8980
	15	527
	25	394
	35	131
	45	57

**APPLICATION DATA:**

**Notes and Definitions:**

Beam spread is to 50% center beam candlepower (CBCP).  
 D=Distance to floor or wall.  
 FC=Footcandles on floor or wall at center beam aiming location.  
 L=Effective Visual Beam length in feet (50% of maximum footcandle level).  
 W=Effective Visual Beam width in feet (50% of maximum footcandle level).  
 CB=Distance across or down to center beam location.

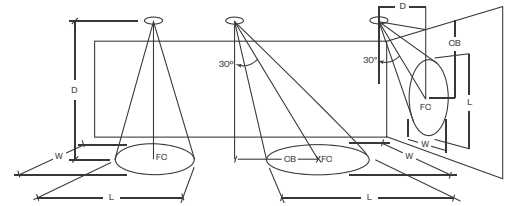

0° Aiming Angle  
Horizontal  
Footcandles



30° Aiming Angle  
Horizontal  
Footcandles



30° Aiming Angle  
Vertical  
Footcandles



60° Aiming Angle  
Vertical  
Footcandles

VERY NARROW SPOT	0° Aiming Angle Horizontal Footcandles				30° Aiming Angle Horizontal Footcandles					30° Aiming Angle Vertical Footcandles					60° Aiming Angle Vertical Footcandles				
	D	FC	L	W	D	FC	L	W	CB	D	FC	L	W	CB	D	FC	L	W	CB
	5.0'	967	1.0	1.0	5.0'	624	1.0	1.0	3.0	3.0'	360	1.5	1.0	5.0	3.0'	983	1.0	1.0	2.0
	7.5'	431	1.1	1.1	7.5'	251	1.8	1.1	4.0	4.0'	185	2.4	1.1	7.0	4.0'	729	1.1	1.0	2.0
	10.0'	243	1.3	1.3	10.0'	153	2.1	1.6	6.0	5.0'	129	2.7	1.2	8.0	5.0'	600	1.1	1.0	3.0
	12.5'	156	1.8	1.8	12.5'	102	2.4	2.2	7.0	6.0'	90	3.3	1.6	10.0	6.0'	325	1.9	1.0	3.0