

CONTOUR 3X4 MULTIPLE RECESSED 2LT LED

CNTR34R-2
LED

APPLICATION:

Retail & commercial accent & display lighting

CONSTRUCTION:

Extruded aluminum heat sink
Stamped aluminum end plates
Formed steel upper housing
Powder coat paint, available in over 200 finishes

ELECTRICAL:

Electronic constant current LED driver
120v or 277v input
Dimming down to less than 20%, available on 120v only with ELV (reverse phase) dimming equipment, consult factory for approved device list

This product complies with IEEE C62.41 for surge endurance up to 2.5KV. Amerlux recommends using additional surge protection with this unit (supplied by others), surge damage is not covered by warranty.

OPTICS:

LED cluster
Color Temp: 2700K, 3000K, 3500K, 4000K
CRI: 85
Life: 50,000 hrs
Lumen Maintenance: >70% of initial lumens @ 50,000 hrs
Lumen output (@ 2700K): 1551 typ Narrow Flood, 1631 typ Medium Flood, 1517 typ Flood 1448 typ Wide Flood
0-45° tilt, 360° rotation
Beam options: Narrow Flood 16°, Medium Flood 24°, Flood 30°, Wide Flood 45°, Very Wide Flood 60°

MOUNTING:

For use in T-Grid & sheet rock ceiling

LABELING:

 For indoor use only



PROJECT:

TYPE:

PRODUCT DISCONTINUED
Replacement Product: HomeTip or C3M Multiples

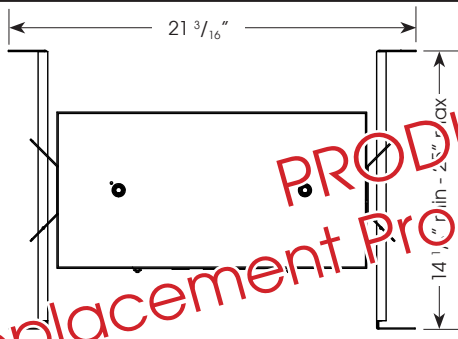

Ceiling cut out dimension: 8 1/8" x 16 1/8"

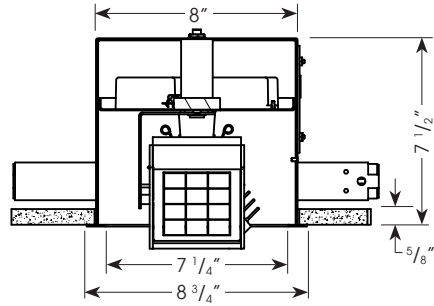
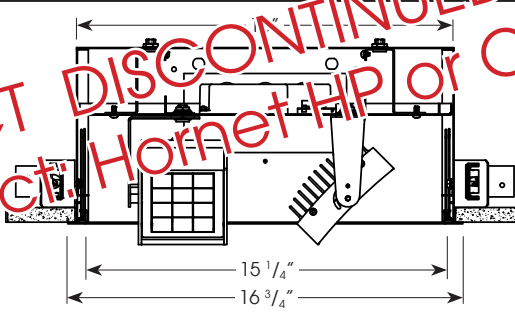

ELECTRICAL

Driver	2x24w Operating	
	Watts	Amps
Electronic 120v	48	.40
277v	48	.17

Class 2 constant current driver, 700 mA

ORDERING INFORMATION:

Model	# Heads	Wattage	Lamp Type	Driver	Housing/ Head Finish	Voltage	Beam Spread Head 1	Beam Spread Head 2	Trim Ring Finish	Color Temp	Options
CNTR34R	2	24	LED	E - electronic	WT - white texture BT - black texture ST - silver texture - (other RAL)	120 277	NF* MFL* FL* WF* VWF SL	NF* MFL* FL* WF* VWF SL	WT - white texture	2700 3000 3500 4000	DIM - dimming (120v only) Snoot (accepts up to 2 forms of light control media) SN - snoot 1", specify WT, BT, ST finish Light Control Media (requires snoot) CB - cross blade 1/2" deep, 9 cell, black (B) finish standard HEX - hexcell louver, 1/8"x1/8" SPR - prismatic spread lens (use only with NF, FL) LSPR - linear spread lens (do not use if SL beam spread is specified)

*Title 24 Compliant

Example: CNTR34R-2-24-LED-E-WT-120-NF-NF-WT-3000

Cat #:

Amerlux reserves the right to change details that do not affect overall function and performance.



CONTOUR 3X4 MULTIPLE RECESSED 2LT LED

CNTR34R-2
LED



TYPE:



FIXTURE DATA:

Note: Data is per lamp
24W LED 2700K

Complete photometric data (ies format) available upon request.

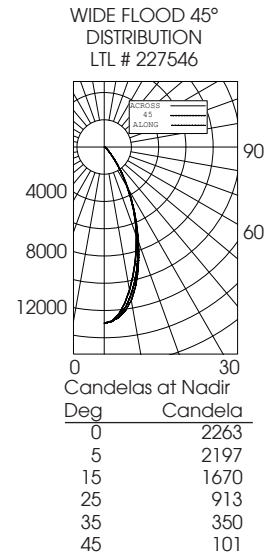
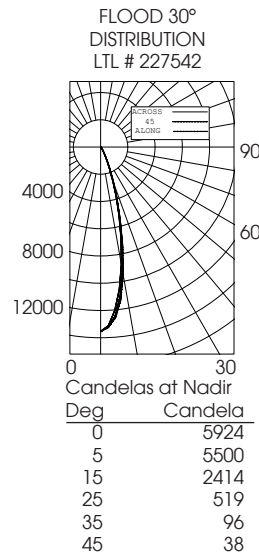
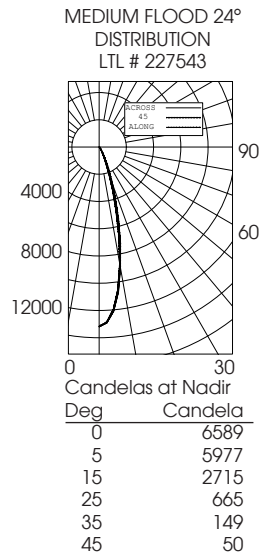
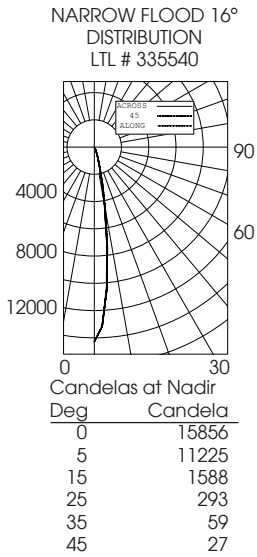

APPLICATION DATA:

Notes and Definitions:

Beam spread is to 50% center beam candlepower (CBCP).
D=Distance to floor or wall.
FC=Footcandles on floor or wall at center beam aiming location.
L=Effective Visual Beam length in feet (50% of maximum footcandle level).
W=Effective Visual Beam width in feet (50% of maximum footcandle level).
CB=Distance across or down to center beam location.

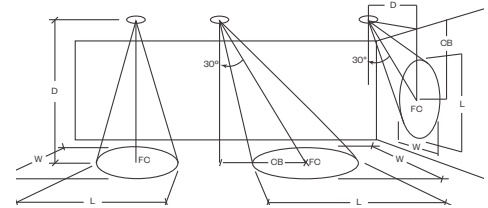

	0° Aiming Angle Horizontal Footcandles				30° Aiming Angle Horizontal Footcandles					30° Aiming Angle Vertical Footcandles					60° Aiming Angle Vertical Footcandles				
	D	FC	L	W	D	FC	L	W	CB	D	FC	L	W	CB	D	FC	L	W	CB
NARROW FLOOD	5.0'	239	2.4	2.3	5.0'	267	2.2	1.8	3.0	3.0'	177	3.1	1.8	5.0	3.0'	489	1.7	1.4	2.0
	7.5'	209	2.3	2.3	7.5'	152	2.9	2.6	4.0	4.0'	113	3.9	2.3	6.0	4.0'	362	2.0	1.6	2.0
	10.0'	131	2.9	2.9	10.0'	87	3.8	3.2	6.0	5.0'	78	4.8	2.7	8.0	5.0'	266	2.3	1.9	3.0
	12.5'	89	3.5	3.5	12.5'	61	4.4	3.8	7.0	6.0'	56	5.6	3.1	9.0	6.0'	195	2.6	2.2	3.0
MEDIUM FLOOD	5.0'	239	2.4	2.3	5.0'	145	3.2	2.8	3.0	3.0'	114	3.7	2.4	4.0	3.0'	320	2.2	1.8	2.0
	7.5'	115	3.4	3.3	7.5'	75	4.4	3.8	4.0	4.0'	68	4.8	3.1	5.0	4.0'	229	2.5	2.3	2.0
	10.0'	66	4.5	4.4	10.0'	43	5.8	5.0	5.0	5.0'	44	6.0	3.8	7.0	5.0'	146	3.2	2.8	3.0
	12.5'	42	5.6	5.5	12.5'	28	7.1	6.3	6.0	6.0'	32	7.2	4.5	8.0	6.0'	111	3.6	3.1	3.0
FLOOD	5.0'	216	2.5	2.4	5.0'	131	3.8	3.2	3.0	3.0'	105	3.6	2.5	4.0	3.0'	290	2.2	1.9	2.0
	7.5'	104	3.4	3.3	7.5'	67	4.5	3.9	4.0	4.0'	63	4.7	3.1	5.0	4.0'	208	2.5	2.3	2.0
	10.0'	60	4.6	4.4	10.0'	39	5.8	5.0	5.0	5.0'	41	5.9	3.9	6.0	5.0'	132	3.3	2.8	3.0
	12.5'	38	5.7	5.5	12.5'	26	7.1	6.2	6.0	6.0'	30	7.0	4.5	8.0	6.0'	101	3.7	3.2	3.0
WIDE FLOOD	5.0'	93	3.5	3.4	5.0'	61	4.3	3.8	2.0	3.0'	59	4.0	3.2	3.0	3.0'	142	2.9	2.6	1.0
	7.5'	42	5.2	5.0	7.5'	29	6.2	5.6	3.0	4.0'	35	4.9	4.0	4.0	4.0'	92	3.5	3.3	2.0
	10.0'	24	7.0	6.7	10.0'	17	8.2	7.4	4.0	5.0'	23	6.3	5.0	5.0	5.0'	63	4.3	3.8	2.0
	12.5'	15	8.8	8.4	12.5'	11	10.4	9.4	5.0	6.0'	16	7.6	6.1	6.0	6.0'	43	5.2	4.7	3.0