

# Concealed Modular Trough



## Product Overview

The Concealed Modular Trough (CMT4) is a linear recessed housing with an aperture of 4.75" that offers a world of flexibility. Allowing you to install various lighting modules within a slim, continuous, single recessed housing. Ceilings never looked so clean. Offered in the latest LED light sources with varying wattages to suit a broad range of applications.

The CMT4 housing only works in a gypsum board ceiling and must be installed before the sheet rock.

The 12" on center opening in the back of the housing must have either a light module or a blanking plate.

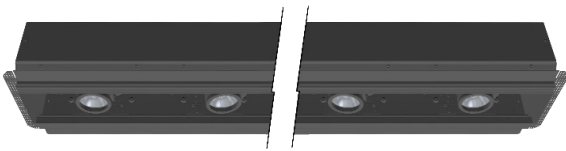

CMT4-HSG

## PROJECT:

SEE PAGES 5-15 FOR LIGHTING MODULES



CMT4-HHP-LM



CMT4-C3M-LM



CMT4-C3-LM

## TYPE:

## Fixture Summary (see following pages for more information)

### Performance Charts

CMT4-HHP-LM				
Watts	Delivered Lumens	LPW	CBCP	Color Temp
11	972	88	8,673	3000K-83
16	1,205	75	10,749	3000K-83
18	1,369	76	12,215	3000K-83

Data is based on 3000K-83, 120V IES files available on website.

Data is per head and based on Spot optic. See pg 8 for other beam spreads.

CMT4-C3M-LM				
Watts	Delivered Lumens	LPW	CBCP	Color Temp
15	1,508	100.5	9,415	3000K-83
18*	1,096	60.2	24,308	3000K-83
21	2,125	101.2	13,260	3000K-83

Data is based on 3000K-83 120V IES files available on website.

15W & 21W data is based on Very Narrow Flood optics, 18W data is Very Narrow Spot optic.

Data is per head. See pgs 10-11 for other beam spreads.

CMT4-C3-LM				
Watts	Delivered Lumens	LPW	CBCP	Color Temp
16	1,700	106.3	6,921	3000K-83
19	2,018	106.2	8,332	3000K-83
23	2,440	106.1	9,934	3000K-83
27	2,880	106.7	11,726	3000K-83
31	3,306	106.6	13,460	3000K-83

Data is based on 3000K-83 120V IES files available on website.

Data is "per head" and based on Flood optics. See pg 13 for other beam spreads.

# Concealed Modular Trough



**PROJECT:**

**TYPE:**

## Ordering Information for Housing



**1** **CMT4-HSG** (use with Horent-HP, C3M or C3 light modules, ordered separately see pages 6, 8 or 11)

**2** **Spacing** (for Light Module or Blanking Plate)  
12 - 12" spacing

**3** **Internal Finish\***  
BT - black texture      *\*White finish is not available*

**4** **Length/Configuration**  
**Individual** (2' - 8' in 1' increments, 9' includes 2 sections)  
2-IND - 2' individual fixture  
3-IND - 3' individual fixture  
4-IND - 4' individual fixture  
5-IND - 5' individual fixture  
6-IND - 6' individual fixture  
7-IND - 7' individual fixture  
8-IND - 8' individual fixture  
(see pg 3 for individual drawings)

**Continuous Run** (> 8', in 1' increments. See table below for breakout of runs. Please order required sections to make up run.)

- 8-BOR - 8' beginning of run
- 4-MOR - 4' middle of run
- 8-MOR - 8' middle of run
- 2-EOR - 2' end of run
- 3-EOR - 3' end of run
- 4-EOR - 4' end of run
- 5-EOR - 5' end of run
- 6-EOR - 6' end of run
- 7-EOR - 7' end of run
- 8-EOR - 8' end of run

**Patterns**  
12" x 12" 90° Corner available (provide drawing/sketch and consult factory)

**5** **Options**  
**1C** - 1 circuit harness 12/3, standard (for use with LE/TE driver only)  
**2C** - 2 circuit harness 12/3 (for use with LE/TE driver only)  
**1C6WIRE** - 1 circuit 12/6 dims (for use with 0-10V, HILUME-H, DALI drivers only)  
**2C6WIRE** - 2 circuit 12/6 dims (for use with 0-10V, HILUME-H, DALI drivers only)

**6** **Accessory**  
CP - Chicago Plenum

**NOTE:**  
**Order Light Modules separately.**  
**See following pages for ordering information.**

## Concealed Modular Trough Continuous Runs

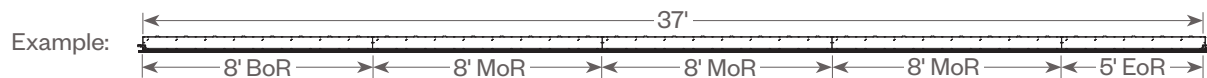

Run Length (ft)	BoR	MoR	EoR	Run Length (ft)	BoR	MoR	EoR	Run Length (ft)	BoR	MoR	EoR
9	(1) 5'	0	(1) 4'	20	(1) 8'	(1) 4'	(1) 8'	31	(1) 8'	(3) 8'	(1) 7'
10	(1) 8'	0	(1) 2'	21	(1) 8'	(1) 8'	(1) 5'	32	(1) 8'	(3) 8'	(1) 8'
11	(1) 8'	0	(1) 3'	22	(1) 8'	(1) 8'	(1) 6'	33	(1) 8'	(1) 4' + (2) 8'	(1) 5'
12	(1) 8'	0	(1) 4'	23	(1) 8'	(1) 8'	(1) 7'	34	(1) 8'	(1) 4' + (2) 8'	(1) 6'
13	(1) 8'	0	(1) 5'	24	(1) 8'	(1) 8'	(1) 8'	35	(1) 8'	(1) 4' + (2) 8'	(1) 7'
14	(1) 8'	0	(1) 6'	25	(1) 8'	(1) 4' + (1) 8'	(1) 5'	36	(1) 8'	(1) 4' + (2) 8'	(1) 8'
15	(1) 8'	0	(1) 7'	26	(1) 8'	(1) 4' + (1) 8'	(1) 6'	37	(1) 8'	(3) 8'	(1) 5'
16	(1) 8'	0	(1) 8'	27	(1) 8'	(1) 4' + (1) 8'	(1) 7'	38	(1) 8'	(3) 8'	(1) 6'
17	(1) 8'	(1) 4'	(1) 5'	28	(1) 8'	(1) 4' + (1) 8'	(1) 8'	39	(1) 8'	(3) 8'	(1) 7'
18	(1) 8'	(1) 4'	(1) 6'	29	(1) 8'	(3) 8'	(1) 5'				
19	(1) 8'	(1) 4'	(1) 7'	30	(1) 8'	(3) 8'	(1) 6'				

# Concealed Modular Trough



## PROJECT:

## TYPE:

### Specifications

#### Application

Retail, commercial and hospitality accent and display lighting

#### Finish

Black texture internal finish

*\*White finish is not available*

#### Construction

Extruded aluminum ceiling trim with grooved spackle surface  
Die-formed, cold-rolled steel housing, end plates and internal components

Wiring harness with quick connect plugs for easy module attachment

Housing lengths are offered in 1 ft. increments

#### Mounting

Housing mounted in gypsum board ceiling.

Installation and ceiling trim spackled by installing contractor.

#### Certifications

cUL listed

Suitable for damp locations

Indoor use only

Chicago Plenum (CCEA) optional

#### Electrical

**1C** - 1 circuit, 12 ga. 3 conductor wire harness (Dims: LE/TE)

**2C** - 2 circuit, 12 ga. 3 conductor wire harness (Dims: LE/TE)

**1C6WIRE** - 1 circuit, 12 ga. 6 conductors harness (Dims:

0-10V, Lutron, E1, E2)

**2C6WIRE** - 2 circuits, 12 ga. 6 conductors harness (Dims:

0-10V, Lutron, E1, E2)

#### Light Modules

Accepts a variety of CMT4-LM lighting modules

See pages 7, 9, and 12 for lighting module options

### Concealed Modular Trough Individual Lengths

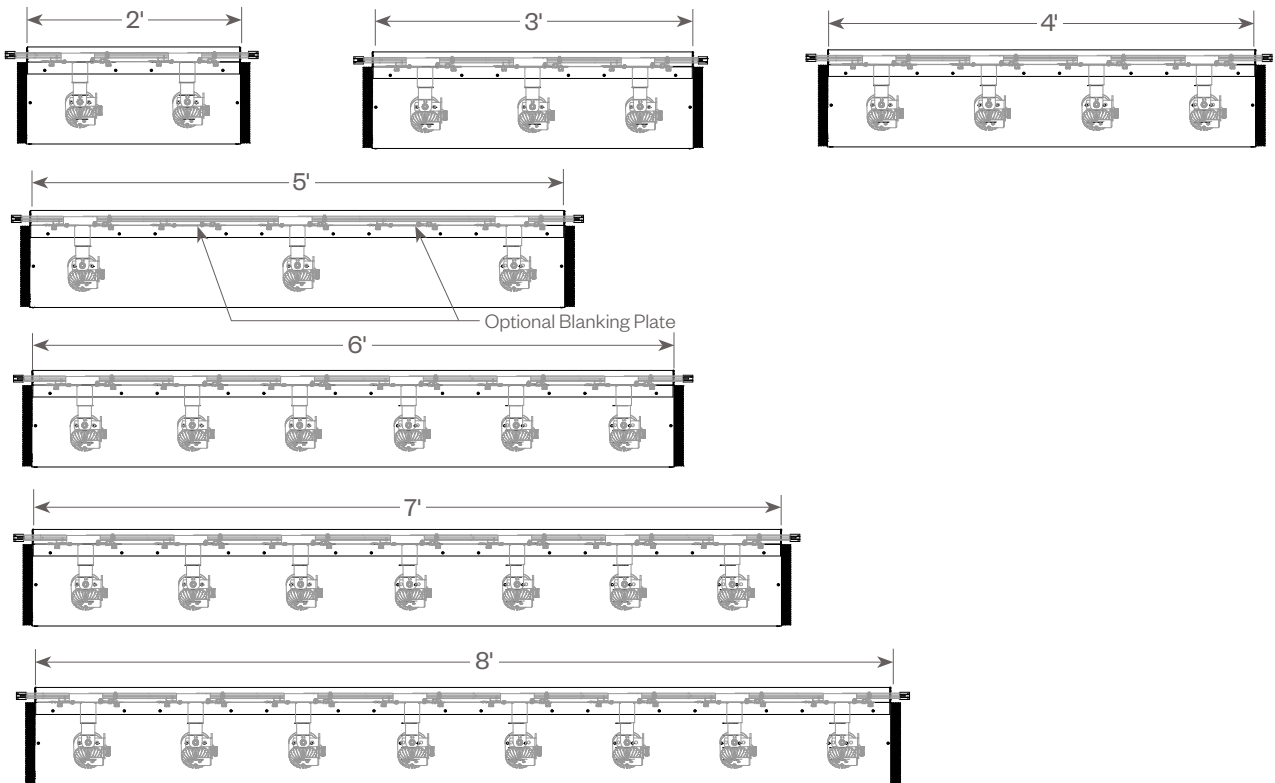

### Concealed Modular Trough Continuous Lengths

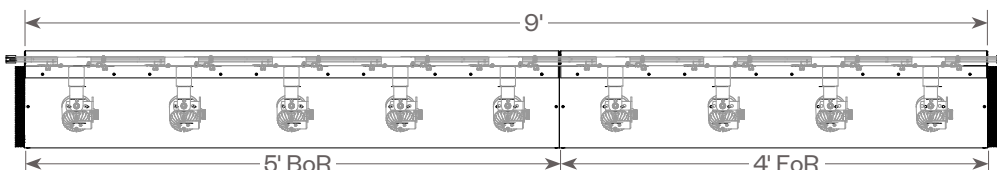

# Concealed Modular Trough

**PROJECT:**

**TYPE:**

**Concealed Modular Trough**

**CMT4-HSG** (use with Hornet-HP, C3M (shown) or C3 light modules)

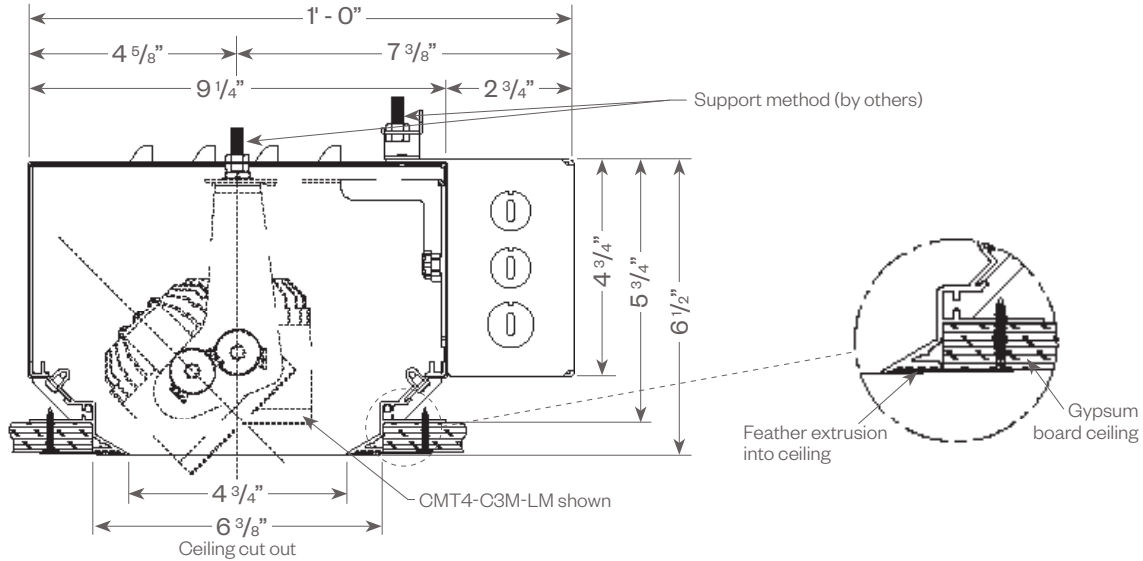

**Lighting Module/Blanking Plate Spacing**

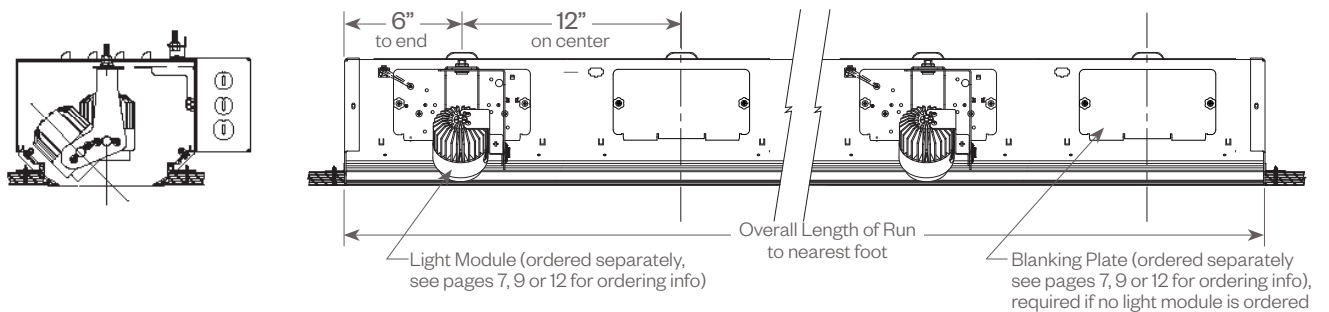

**CORNER**

*Note: Light module cannot be placed inside the corner*

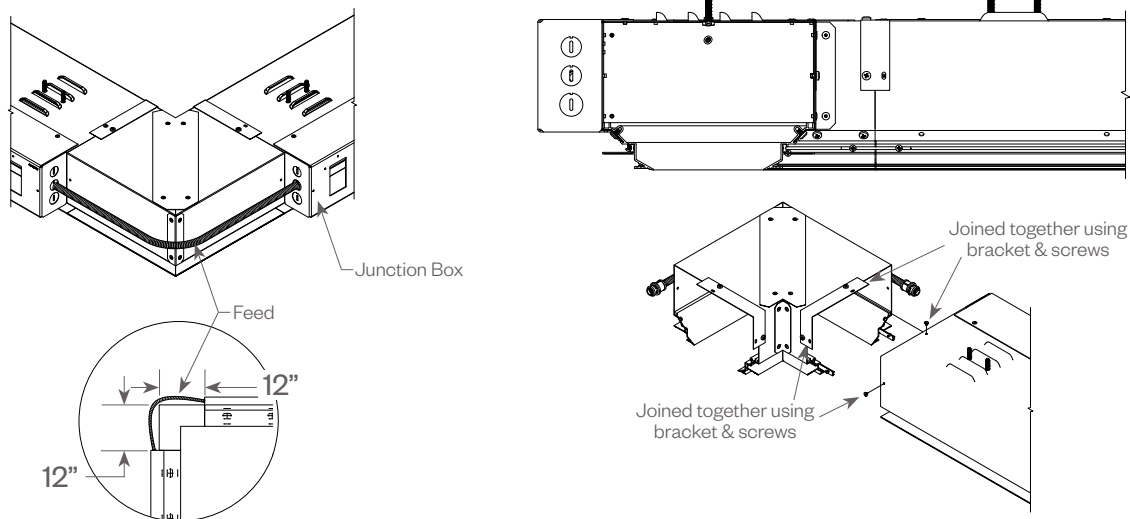

# Concealed Modular Trough



## Product Overview

The Concealed Modular Trough (CMT4) is a linear recessed housing with an aperture of 4.75" that offers a world of flexibility. Allowing you to install various lighting modules within a slim, continuous, single recessed housing. Ceilings never looked so clean. Offered in the latest LED light sources with varying wattages to suit a broad range of applications.

The CMT4 housing only works in a gypsum board ceiling and must be installed before the sheet rock.

The 12" on center opening in the back of the housing must have either a light module or a blanking plate.

SEE PAGES 1-4 FOR HOUSING

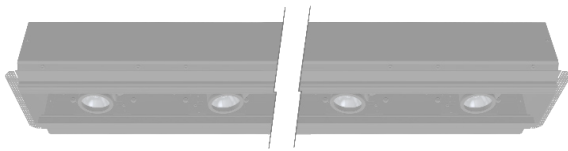

CMT4-HSG

## PROJECT:

## TYPE:



CMT4-HHP-LM



CMT4-C3M-LM



CMT4-C3-LM

## Fixture Summary *(see following pages for more information)*

### Performance Charts

CMT4-HHP-LM				
Watts	Delivered Lumens	LPW	CBCP	Color Temp
11	972	88	8,673	3000K-83
16	1,205	75	10,749	3000K-83
18	1,369	76	12,215	3000K-83

*Data is based on 3000K-83, 120V IES files available on website.*

*Data is per head and based on Spot optic. See pg 7 for other beam spreads.*

CMT4-C3M-LM				
Watts	Delivered Lumens	LPW	CBCP	Color Temp
15	1,508	100.5	9,415	3000K-83
18*	1,096	60.2	24,308	3000K-83
21	2,125	101.2	13,260	3000K-83

*\*Note: 18W is VNSP only*

*Data is based on 3000K-83 120V IES files available on website.*

*15W & 21W data is based on Very Narrow Flood optics, 18W data is Very Narrow Spot optic.*

*Data is per head. See pgs 10-11 for other beam spreads.*

CMT4-C3-LM				
Watts	Delivered Lumens	t	CBCP	Color Temp
16	1,700	106.3	6,921	3000K-83
19	2,018	106.2	8,332	3000K-83
23	2,440	106.1	9,934	3000K-83
27	2,880	106.7	11,726	3000K-83
31	3,306	106.6	13,460	3000K-83

*Data is based on 3000K-83 120V IES files available on website.*

*Data is "per head" and based on Flood optics. See pg 13 for other beam spreads.*

# Light Module Electrical Data



**PROJECT:**

**TYPE:**

## Electrical Data

### - with Hornet HP Light Module

CMT4-HHP-LM						
	11W		16W		18W	
	System Watts	Amps	System Watts	Amps	System Watts	Amps
120V	11	0.09	16	0.13	18	0.15
277V	11	0.04	16	0.06	18	0.07

*Electronic constant current LED driver*

*Data per head*

### - with C3M Light Module

CMT4-C3M-LM						
	15W		18W		21W	
	System Watts	Amps	System Watts	Amps	System Watts	Amps
120V	15	0.13	18	0.15	21	0.18
277V	15	0.05	18	0.06	21	0.08

*Electronic constant current LED driver*

*Data per head*

### - with C3 Light Module

CMT4-C3-LM										
	16W		19W		23W		27W		31W	
	System Watts	Amps	System Watts	Amps	System Watts	Amps	System Watts	Amps	System Watts	Amps
120V	16	0.13	19	0.16	23	0.19	27	0.23	31	0.26
277V	16	0.06	19	0.07	23	0.08	27	0.10	31	0.11

*Electronic constant current LED driver*

*Data per head*

# Hornet HP LED Light Module

Use with Concealed Modular Trough (CMT4-HSG)



## PROJECT:

## TYPE:

### Ordering Information for Hornet HP Light Module



**1 Model**  
**CMT4-HHP-LM** (use with CMT4 housing)  
**CMT4 - BP** - blanking plate, black (items 2-8 do not apply with this selection)  
**Note: Whole length must have 1 light module or blanking plate per foot**

**2 Wattage**  
 11  
 16  
 18

**3 Internal Finish**  
 BT - black texture

**4 Voltage**  
 120  
 277

**5 Beam Spread**  
 SP - spot, 15°  
 NF - narrow flood, 22°  
 MFL - medium flood, 25°  
 FL - flood, 28°  
 WF - wide flood, 45°  
 VWF - very wide flood, 60°  
 LS - linear spread lens, 60° x 10°

**6 Color Temp**

<b>83 CRI:</b>	<b>90+ CRI:</b>	
<b>27</b> - 2700K-83	<b>229*</b> - 2200K-90+	<b>CRISP*</b> - CrispWhite
<b>30</b> - 3000K-83	<b>279</b> - 2700K-90+	<b>3CLA</b> - 3K Class A
<b>35</b> - 3500K-83	<b>309</b> - 3000K-90+	
<b>40</b> - 4000K-83	<b>359</b> - 3500K-90+	
	<b>409</b> - 4000K-90+	

*\* Not available for 18W*

**7 Driver**  
**LE/TE** - TRIAC/ELV dimming driver, 5% dim (for use with 1C or 2C harness)  
**0-10V** - 0-10V dimming driver, 1% dim (for use with 1C6WIRE, 2C6WIRE or 0-10V harness)  
**HILUME-H-ECO** - Lutron Hi-lume® H Series, EcoSystem, 1% dim with soft on, fade to black (for use with 1C6WIRE or 2C6WIRE harness)  
**DALI** - EdoLED; 1% dim (for use with 1C6WIRE or 2C6WIRE harness)

**8 Options**  
**SNAH** - snoot accessory holder, 1" length, matte black interior, exterior finish matches fixture finish, accepts cross blade plus 2 additional forms of media  
**AH** - accessory holder, specify finish (WT, BT, ST), accepts (2) 1/8" forms of media and optical film  
**HEX** - hexcell louver, (1/8" x 1/8") (requires SNAH or AH)  
**CB** - cross blade, matte black (requires SNAH)  
**SOL** - solite lens (requires SNAH or AH)

**NOTE:**  
**Order CMT4 housing separately.**  
**See page 2 for ordering information.**

### CMT4-HHP-LM (Hornet Hp Light Module use with CMT4 housing)

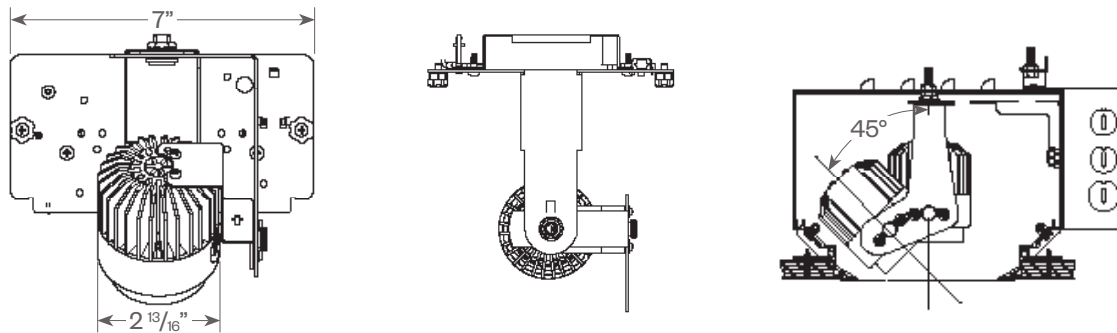

### Accessories (diagrams show installation order)



Accessory holder, hexcell louver, solite lens

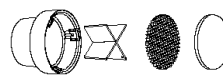

Snoot accessory holder, cross blade, hexcell louver, solite lens

# Hornet HP LED Light Module

Use with Concealed Modular Trough (CMT4-HSG)



## PROJECT:

## TYPE:

**FIXTURE DATA:** (Complete photometric data (.ies format) available upon request)

**MULTIPLYING FACTORS:** (Multiplying Factor is based on 3000K-83 120V IES file on website)

Wattage:	11W	16W	18W
Factor:	0.71	0.88	1.0

	83 CRI	90+ CRI
R9 Value:	11	55

CCT:	2700K-83	3000K-83	3500K-83	4000K-83
Factor:	0.96	1.0	1.02	1.04

CCT:	2200K-90+	2700K-90+	3000K-90+	3500K-90+	4000K-90+	CRISP	3CLA
Factor:	0.71	0.80	0.83	0.87	0.90	0.65	0.75

### 18W LED, 3000K-83

Spot (SP) Distribution, 15°  
LTL #855377  
Lumens: 1,369

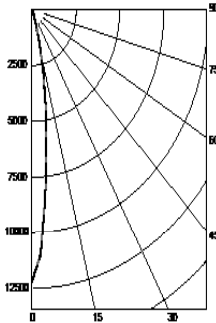

**Candelas at Nadir**

Deg	Candela
0	12215
5	8436
15	1705
25	204
35	77
45	26

Narrow Flood (NF) Distribution, 22°  
LTL #860527  
Lumens: 1,307

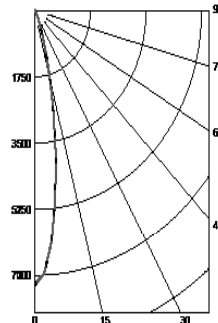

**Candelas at Nadir**

Deg	Candela
0	7252
5	6128
15	1841
25	309
35	93
45	41

Flood (FL) Distribution, 28°  
LTL # 860528  
Lumens: 1,285

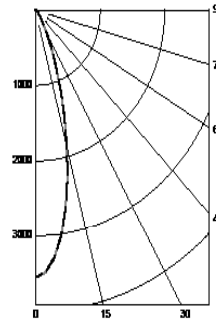

**Candelas at Nadir**

Deg	Candela
0	3551
5	3304
15	1861
25	612
35	156
45	57

Wide Flood (WF) Distribution, 45°  
LTL # 860529  
Lumens: 1,278

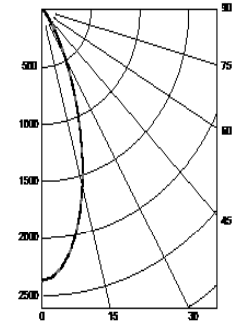

**Candelas at Nadir**

Deg	Candela
0	2369
5	2268
15	1592
25	754
35	251
45	82

### Application Data:

#### Notes and Definitions:

Beam spread is to 50% center beam candlepower (CBCP).

D=Distance to floor or wall.

FC=Footcandles on floor or wall at center beam aiming location.

L=Effective Visual Beam length in feet (50% of maximum footcandle level).

W=Effective Visual Beam width in feet (50% of maximum footcandle level).

CB=Distance across or down to center beam location.

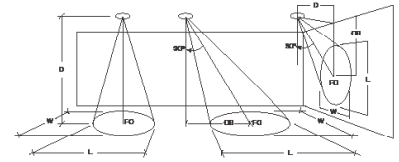

	0° Aiming Angle Horizontal Footcandles				30° Aiming Angle Horizontal Footcandles					30° Aiming Angle Vertical Footcandles					60° Aiming Angle Vertical Footcandles				
	D	FC	L	W	D	FC	L	W	CB	D	FC	L	W	CB	D	FC	L	W	CB
Spot	5.0'	484	1.4	1.4	5.0'	313	1.8	1.5	3.0	3.0'	178	3.0	1.6	5.0	3.0'	630	1.6	1.1	2.0
	7.5'	216	2.0	2.0	7.5'	136	2.8	2.4	4.0	4.0'	105	3.8	2.1	6.0	4.0'	450	1.6	1.3	2.0
	10.0'	122	2.7	2.7	10.0'	76	3.7	3.2	6.0	5.0'	67	4.8	2.7	8.0	5.0'	298	2.0	1.6	3.0
	12.5'	78	3.4	3.4	12.5'	46	4.8	4.2	7.0	6.0'	47	5.9	3.2	9.0	6.0'	200	2.4	1.9	3.0
Narrow Flood	5.0'	289	1.7	1.7	5.0'	187	2.4	2.1	3.0	3.0'	127	3.3	1.8	4.0	3.0'	422	1.9	1.3	2.0
	7.5'	129	2.8	2.8	7.5'	86	3.5	3.1	4.0	4.0'	70	4.4	2.7	6.0	4.0'	298	1.9	1.5	2.0
	10.0'	73	3.6	3.6	10.0'	47	4.7	4.1	5.0	5.0'	47	5.3	3.2	7.0	5.0'	181	2.5	2.1	3.0
	12.5'	47	4.5	4.5	12.5'	31	5.8	5.2	7.0	6.0'	32	6.7	3.9	8.0	6.0'	133	2.8	2.5	3.0
Flood	5.0'	142	2.7	2.7	5.0'	92	3.4	3.1	3.0	3.0'	75	3.8	2.7	4.0	3.0'	232	2.3	1.7	2.0
	7.5'	63	3.9	3.9	7.5'	43	4.9	4.4	4.0	4.0'	44	4.9	3.3	5.0	4.0'	154	2.7	2.4	2.0
	10.0'	36	5.2	5.2	10.0'	25	6.4	5.8	5.0	5.0'	29	6.1	4.1	6.0	5.0'	95	3.4	3.0	2.0
	12.5'	23	6.5	6.5	12.5'	16	8.0	7.2	6.0	6.0'	20	7.4	5.1	7.0	6.0'	69	3.8	3.5	3.0
Wide Flood	5.0'	95	3.2	3.2	5.0'	67	3.9	3.4	2.0	3.0'	63	3.7	2.8	3.0	3.0'	180	2.4	2.0	1.0
	7.5'	42	4.8	4.8	7.5'	30	5.7	5.3	3.0	4.0'	36	4.9	3.7	4.0	4.0'	105	3.2	2.9	2.0
	10.0'	24	6.4	6.4	10.0'	17	7.6	7.1	4.0	5.0'	23	6.1	4.8	5.0	5.0'	69	3.8	3.5	2.0
	12.5'	15	8.0	8.0	12.5'	11	9.6	8.9	5.0	6.0'	16	7.5	5.7	6.0	6.0'	47	4.7	4.3	3.0



# Cylindrix® III Mini Light Module

Use with Concealed Modular Trough (CMT4-HSG)



## PROJECT:

## TYPE:

### Ordering Information for C3M Light Module



**1 Model**  
**CMT4-C3M-LM** (use with CMT4 housing)  
**CMT4 - BP** - blanking plate, black (items 2-8 do not apply with this selection)  
**Note: Whole length must have 1 light module or blanking plate per foot**

**2 Wattage**  
 15  
 18 (VNSP only)  
 21

**3 Internal Finish**  
**BT** - black texture

**4 Voltage**  
 120  
 277

**5 Beam Spread**  
**VNSP** - very narrow spot, 8° (18W only)  
**SP** - spot, 14°  
**VNF** - very narrow flood, 18°  
**NF** - narrow flood, 23°  
**FL** - flood, 34°  
**WF** - wide flood, 44°  
**LS** - linear spread lens, 60°x10°

**6 Color Temp**  
 83 CRI:                      90+ CRI:  
**27** - 2700K-83    **229\*** - 2200K-90+    **CRISP\*** - CrispWhite  
**30** - 3000K-83    **279** - 2700K-90+    **3CLA** - 3K Class A  
**35** - 3500K-83    **309** - 3000K-90+  
**40** - 4000K-83    **359** - 3500K-90+  
                          **409** - 4000K-90+  
**\* Not available for 18W**

**7 Driver**  
**LE/TE** - TRIAC/ELV dimming driver, 5% dim (for use with 1C or 2C harness)  
**0-10V** - 0-10V dimming driver, 1% dim (for use with 1C6WIRE, 2C6WIRE or 0-10V harness)  
**HILUME-H-ECO** - Lutron Hi-lume® H Series, EcoSystem, 1% dim with soft on, fade to black (for use with 1C6WIRE or 2C6WIRE harness)  
**DALI** - EldoLED; 1% dim (for use with 1C6WIRE or 2C6WIRE harness)

**8 Options**  
**SN** - snoot, 1" length, matte black interior, exterior finish matches fixture finish, accepts up to 2 accessories + cross blade)  
**HEX** - hexcell louver  
**SOL** - solite beam softening lens  
**CB** - cross blade, matte black (requires snoot)

**NOTE:**  
**Order CMT4 housing separately.**  
**See page 2 for ordering information.**

### CMT4-C3M-LM (Cylindrix III Mini Light Module use with CMT4 housing)

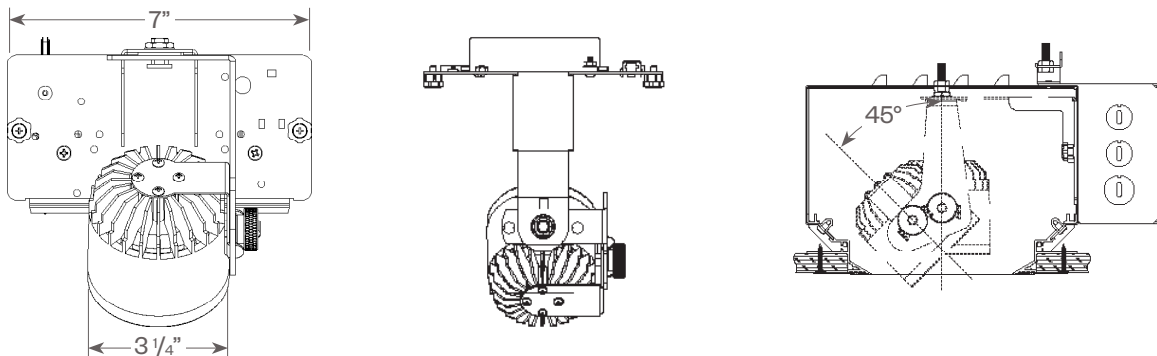

### Accessories (diagrams show installation order)

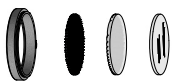

Front door/Accessory holder, hexcell, linear spread lens, solite lens



Snoot accessory holder, cross blade, hexcell, linear spread lens, solite lens

# Cylindrix® III Mini Light Module

Use with Concealed Modular Trough (CMT4-HSG)



## PROJECT:

## TYPE:

**FIXTURE DATA:** (Complete photometric data (.ies format) available upon request)

**MULTIPLYING FACTORS:** (Multiplying Factor is based on 3000K-83 120V IES file on website)

Wattage:	15W	21W
Factor:	0.71	1.0

Note: For 18W (VNSP only) data see pg 10

	83 CRI	90+ CRI
R9 Value:	11	55

CCT:	2700K-83	3000K-83	3500K-83	4000K-83
Factor:	0.96	1.0	1.02	1.04

CCT:	2200K-90+	2700K-90+	3000K-90+	3500K-90+	4000K-90+	CRISP*	3CLA
Factor:	0.66	0.83	0.86	0.90	0.93	0.65	0.70

### 21W LED, 3000K-83

Note: Data per head

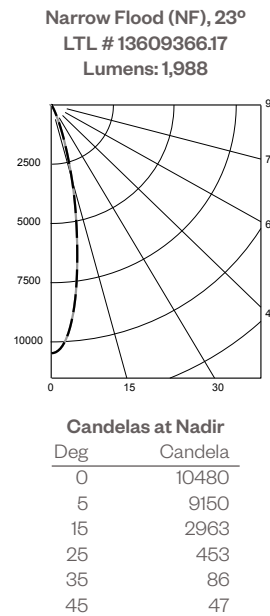
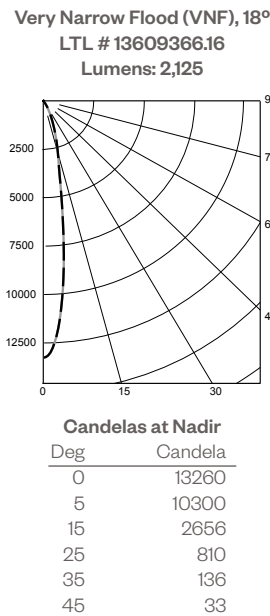
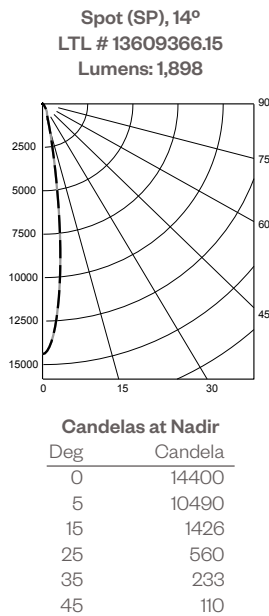

Note: For FL & WF data see pg 11

### APPLICATION DATA:

#### Notes and Definitions:

- Beam spread is to 50% center beam candlepower (CBCP).
- D=Distance to floor or wall.
- FC=Footcandles on floor or wall at center beam aiming location.
- L=Effective Visual Beam length in feet (50% of maximum footcandle level).
- W=Effective Visual Beam width in feet (50% of maximum footcandle level).
- CB=Distance across or down to center beam location.

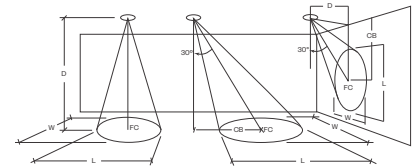

	0° Aiming Angle Horizontal Footcandles				30° Aiming Angle Horizontal Footcandles					30° Aiming Angle Vertical Footcandles					60° Aiming Angle Vertical Footcandles				
	D	FC	L	W	D	FC	L	W	CB	D	FC	L	W	CB	D	FC	L	W	CB
SPOT	5.0'	575	1.2	1.2	5.0'	371	1.6	1.4	3.0	3.0'	216	2.8	1.4	5.0	3.0'	779	1.3	1.1	2.0
	7.5'	256	1.9	1.9	7.5'	166	2.5	2.2	4.0	4.0'	130	3.5	1.8	6.0	4.0'	555	1.5	1.2	2.0
	10.0'	144	2.7	2.7	10.0'	92	3.4	3.0	6.0	5.0'	82	4.3	2.5	8.0	5.0'	361	1.8	1.4	3.0
	12.5'	93	3.2	3.2	12.5'	61	4.1	3.6	7.0	6.0'	58	5.2	2.9	9.0	6.0'	247	2.2	1.6	3.0
VERY NARROW FLOOD	5.0'	531	1.4	1.4	5.0'	342	1.9	1.5	3.0	3.0'	200	3.4	1.6	5.0	3.0'	745	1.5	1.2	2.0
	7.5'	236	2.2	2.2	7.5'	155	2.9	2.6	4.0	4.0'	124	4.1	2.1	6.0	4.0'	529	1.7	1.3	2.0
	10.0'	133	3.0	3.0	10.0'	85	3.9	3.4	6.0	5.0'	77	5.2	2.9	7.0	5.0'	333	2.1	1.6	3.0
	12.5'	85	3.6	3.6	12.5'	57	4.7	4.1	7.0	6.0'	56	6.2	3.2	9.0	6.0'	235	2.4	1.9	3.0
NARROW FLOOD	5.0'	420	1.8	1.8	5.0'	271	2.5	2.2	3.0	3.0'	193	3.2	1.8	4.0	3.0'	628	1.9	1.3	2.0
	7.5'	187	2.9	2.9	7.5'	126	3.5	3.2	4.0	4.0'	105	4.5	2.8	6.0	4.0'	443	1.9	1.6	2.0
	10.0'	105	3.7	3.7	10.0'	71	4.8	4.2	5.0	5.0'	70	5.4	3.3	7.0	5.0'	265	2.6	2.2	3.0
	12.5'	67	4.7	4.7	12.5'	45	6.0	5.4	7.0	6.0'	49	6.6	3.9	8.0	6.0'	197	2.9	2.6	3.0

# Cylindrix® III Mini Light Module

Use with Concealed Modular Trough (CMT4-HSG)



**PROJECT:**

**TYPE:**

**FIXTURE DATA:** (Complete photometric data (.ies format) available upon request)

**MULTIPLYING FACTORS:** (Multiplying Factor is based on 3000K-83 120V IES file on website)

<b>Wattage:</b>	<b>15W</b>	<b>21W</b>
Factor:	0.71	1.0

	<b>83 CRI</b>	<b>90+ CRI</b>
R9 Value:	11	55

<b>CCT:</b>	<b>2700K-83</b>	<b>3000K-83</b>	<b>3500K-83</b>	<b>4000K-83</b>
Factor:	0.96	1.0	1.02	1.04

<b>CCT:</b>	<b>2200K-90+</b>	<b>2700K-90+</b>	<b>3000K-90+</b>	<b>3500K-90+</b>	<b>4000K-90+</b>	<b>CRISP*</b>	<b>3CLA</b>
Factor:	0.66	0.83	0.86	0.90	0.93	0.65	0.70

\* Not available for use with 18W VNSP

**21W LED, 3000K-83**

Note: Data per head

Flood (FL), 34°  
LTL # 13609366.18  
Lumens: 1,960

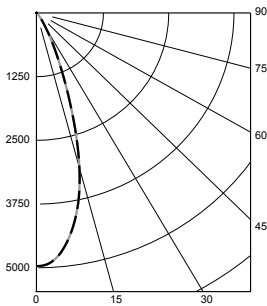

**Candelas at Nadir**

Deg	Candela
0	4970
5	4780
15	3130
25	913
35	193
45	55

Wide Flood (WF), 44°  
LTL # 13609366.19  
Lumens: 1,930

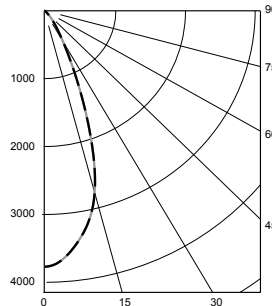

**Candelas at Nadir**

Deg	Candela
0	3771
5	3624
15	2758
25	1034
35	308
45	101

Note: For SP, VNF, NF data see pg 10

**18W LED, 3000K (VNSP only)**

Very Narrow Spot (VNSP), 8°  
LTL #1170140  
Lumens: 1,096

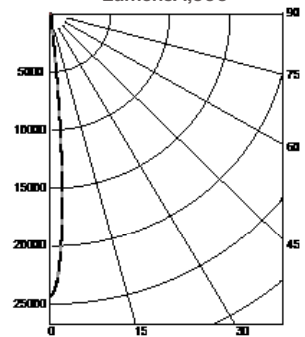

**Candelas at Nadir**

Deg	Candela
0	24308
5	8980
15	527
25	394
35	131
45	57

**APPLICATION DATA:**

**Notes and Definitions:**

- Beam spread is to 50% center beam candlepower (CBCP).
- D=Distance to floor or wall.
- FC=Footcandles on floor or wall at center beam aiming location.
- L=Effective Visual Beam length in feet (50% of maximum footcandle level).
- W=Effective Visual Beam width in feet (50% of maximum footcandle level).
- CB=Distance across or down to center beam location.

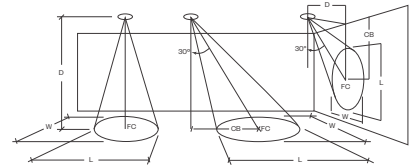

	0° Aiming Angle Horizontal Footcandles				30° Aiming Angle Horizontal Footcandles					30° Aiming Angle Vertical Footcandles					60° Aiming Angle Vertical Footcandles				
	D	FC	L	W	D	FC	L	W	CB	D	FC	L	W	CB	D	FC	L	W	CB
FLOOD	5.0'	199	3.0	3.0	5.0'	141	3.5	3.1	2.0	3.0'	124	3.3	2.7	3.0	3.0'	372	2.2	1.8	1.0
	7.5'	89	4.4	4.4	7.5'	63	5.2	4.8	3.0	4.0'	70	4.5	3.4	4.0	4.0'	221	2.9	2.7	2.0
	10.0'	50	5.8	5.8	10.0'	36	6.9	6.4	4.0	5.0'	45	5.6	4.4	5.0	5.0'	143	3.5	3.1	2.0
	12.5'	32	7.3	7.3	12.5'	23	8.6	8.0	6.0	6.0'	32	6.8	5.2	7.0	6.0'	98	4.2	3.9	3.0
WIDE FLOOD	5.0'	151	3.2	3.2	5.0'	110	3.8	3.5	2.0	3.0'	109	3.2	2.7	3.0	3.0'	303	2.3	2.0	1.0
	7.5'	67	5.0	5.0	7.5'	49	5.6	5.4	3.0	4.0'	62	4.2	3.6	4.0	4.0'	167	3.1	3.0	2.0
	10.0'	38	6.6	6.6	10.0'	28	7.5	7.3	4.0	5.0'	40	5.3	4.6	5.0	5.0'	111	3.8	3.5	2.0
	12.5'	25	8.3	8.3	12.5'	18	9.5	9.1	5.0	6.0'	28	6.5	5.5	6.0	6.0'	76	4.6	4.5	2.0
18W only VERY NARROW SPOT	5.0'	967	1.0	1.0	5.0'	624	1.0	1.0	3.0	3.0'	360	1.5	1.0	5.0	3.0'	983	1.0	1.0	2.0
	7.5'	431	1.1	1.1	7.5'	251	1.8	1.1	4.0	4.0'	185	2.4	1.1	7.0	4.0'	729	1.1	1.0	2.0
	10.0'	243	1.3	1.3	10.0'	153	2.1	1.6	6.0	5.0'	129	2.7	1.2	8.0	5.0'	600	1.1	1.0	3.0
	12.5'	156	1.8	1.8	12.5'	102	2.4	2.2	7.0	6.0'	90	3.3	1.6	10.0	6.0'	325	1.9	1.0	3.0

# Cylindrix® III Light Module

Use with Concealed Modular Trough (CMT4-HSG)



## PROJECT:

## TYPE:

### Ordering Information for C3 Light Module



- 1 Model**  
**CMT4-C3-LM** (use with CMT4 housing)  
**CMT4 - BP** - blanking plate, black (items 2-8 do not apply with this selection)  
**Note: Whole length must have 1 light module or blanking plate per foot**
- 2 Wattage**  
 16  
 19  
 23  
 27  
 31
- 3 Internal Finish**  
**BT** - black texture
- 4 Voltage**  
 120  
 277
- 5 Beam Spread**  
**NSP** - narrow spot, 10° (based on availability, lead times may vary, consult factory)  
**SP** - spot, 15°  
**FL** - flood, 25°  
**WF** - wide flood, 40°  
**LS** - linear spread, 60° x 10°
- 6 Color Temp**  

<b>83 CRI:</b>	<b>90+ CRI:</b>	
<b>27</b> - 2700K-83	<b>279</b> - 2700K-90+	<b>CRISP+</b> - CrispWhite
<b>30</b> - 3000K-83	<b>309</b> - 3000K-90+	<b>3CLA+</b> - 3K Class A
<b>35</b> - 3500K-83	<b>359</b> - 3500K-90+	
<b>40</b> - 4000K-83	<b>409</b> - 4000K-90+	

**\* Not available with NSP beam spread**
- 7 Driver**  
**LE/TE** - TRIAC/ELV dimming driver, 5% dim (for use with 1C or 2C harness)  
**0-10V** - 0-10V dimming driver, 1% dim (for use with 1C6WIRE, 2C6WIRE or 0-10V harness)  
**HILUME-H-ECO** - Lutron Hi-lume® H Series, EcoSystem, 1% dim with soft on, fade to black (for use with 1C6WIRE or 2C6WIRE harness)  
**DALI** - EldoLED; 1% dim (for use with 1C6WIRE or 2C6WIRE harness)
- 8 Options**  
 (standard front door accepts 1 accessory)  
**SN34** - snoot 3/4" length, matte black interior, exterior finish matches fixture finish; accepts up to 2 accessories  
**SN15** - snoot 1-1/2" length, matte black interior, exterior finish matches fixture finish; accepts up to 2 accessories  
**HEX** - hexcell louver  
**SOL** - solite beam softening lens  
**CB** - cross blade, matte black finish (requires snoot)

**NOTE:**  
 Order CMT4 housing separately.  
 See page 2 for ordering information.

### CMT4-C3-LM (Cylindrix III Light Module use with CMT4 housing)

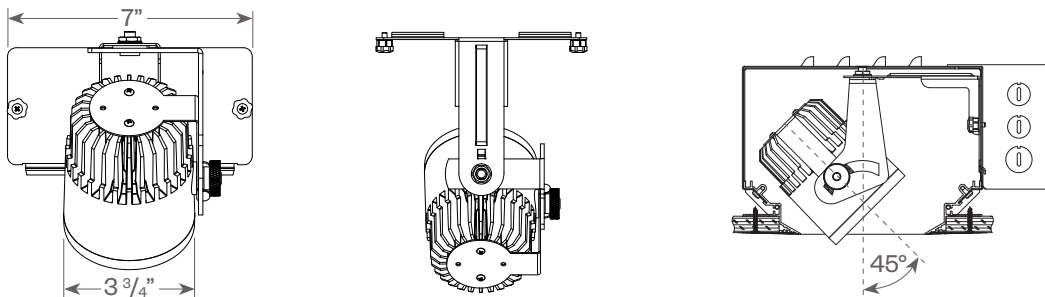

### Accessories

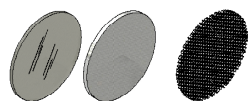

Clear lens, Solite lens, Hexcell louver (fits in front door)



Snoot, 3/4" deep



Snoot, 1 1/2" deep



Linear spread lens, Hexcell louver, Cross blade (requires snoot)

# Cylindrix® III Light Module

Use with Concealed Modular Trough (CMT4-HSG)



**PROJECT:**

**TYPE:**

**FIXTURE DATA:** (Complete photometric data (.ies format) available upon request)

**MULTIPLYING FACTORS:** (Multiplying Factor is based on 3500K-83 120V IES file on website)

Wattage:	16W	19W	23W	27W	31W
Factor:	0.51	0.61	0.74	0.87	1.0

	83 CRI	90+ CRI
R9 Value:	11	55

CCT:	2700K-83	3000K-83	3500K-83	4000K-83	2700K-90+	3000K-90+	3500K-90+	4000K-90+	CRISP	3CLA
Factor:	0.96	1.0	1.02	1.04	0.83	0.86	0.90	0.93	0.65	0.70

## 31W LED, 3000K-83

**Narrow Spot (NSP), 10°**  
LTL #11906314.01A  
Lumens: 2,426

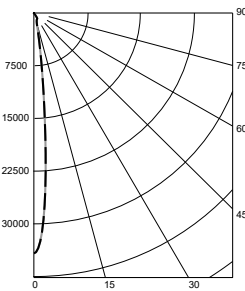

**Candelas at Nadir**

Deg	Candela
0	34180
5	17580
15	1541
25	979
35	195
45	18

**Spot (SP), 15°**  
LTL # 13609366.09  
Lumens: 3264

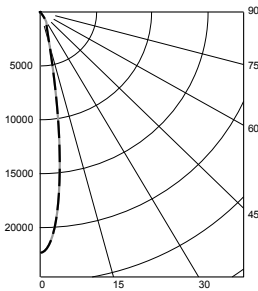

**Candelas at Nadir**

Deg	Candela
0	22340
5	17770
15	3015
25	1305
35	383
45	27

**Flood (FL), 25°**  
LTL # 13609366.10  
Lumens: 3306

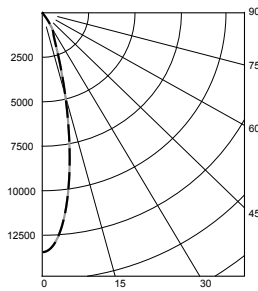

**Candelas at Nadir**

Deg	Candela
0	13460
5	11970
15	4475
25	1407
35	378
45	28

**Wide Flood (WF), 40°**  
LTL # 13609366.11  
Lumens: 3257

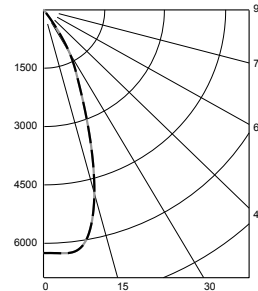

**Candelas at Nadir**

Deg	Candela
0	6252
5	6280
15	4839
25	2030
35	442
45	33

## APPLICATION DATA:

### Notes and Definitions:

Beam spread is to 50% center beam candlepower (CBCP).

D=Distance to floor or wall.

FC=Footcandles on floor or wall at center beam aiming location.

L=Effective Visual Beam length in feet (50% of maximum footcandle level).

W=Effective Visual Beam width in feet (50% of maximum footcandle level).

CB=Distance across or down to center beam location.

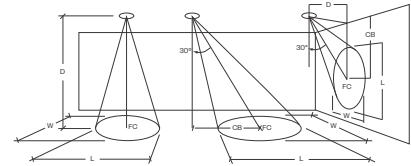

	0° Aiming Angle Horizontal Footcandles				30° Aiming Angle Horizontal Footcandles					30° Aiming Angle Vertical Footcandles					60° Aiming Angle Vertical Footcandles				
	D	FC	L	W	D	FC	L	W	CB	D	FC	L	W	CB	D	FC	L	W	CB
NARROW SPOT	5.0'	1367	1.1	1.1	5.0'	839	1.3	1.1	3.0	3.0'	508	2.0	1.1	5.0	3.0'	1553	1.1	1.0	2.0
	7.5'	608	1.3	1.3	7.5'	384	1.9	1.4	4.0	4.0'	261	2.9	1.4	7.0	4.0'	1131	1.2	1.1	2.0
	10.0'	342	1.7	1.7	10.0'	211	2.5	2.1	6.0	5.0'	186	3.3	1.6	8.0	5.0'	846	1.2	1.1	3.0
	12.5'	219	2.3	2.3	12.5'	143	3.0	2.7	7.0	6.0'	128	4.0	2.1	10.0	6.0'	503	2.0	1.3	3.0
SPOT	5.0'	894	1.3	1.3	5.0'	559	2.1	1.5	3.0	3.0'	338	3.1	1.5	5.0	3.0'	1275	1.4	1.1	2.0
	7.5'	398	2.2	2.2	7.5'	265	2.8	2.5	4.0	4.0'	212	3.8	2.0	6.0	4.0'	903	1.6	1.2	2.0
	10.0'	224	2.9	2.9	10.0'	145	3.9	3.3	5.0	5.0'	132	4.8	2.7	7.0	5.0'	561	2.1	1.5	3.0
	12.5'	144	3.6	3.6	12.5'	95	4.7	4.2	7.0	6.0'	95	5.6	3.1	9.0	6.0'	402	2.3	1.8	3.0
FLOOD	5.0'	539	2.0	2.0	5.0'	338	2.8	2.5	3.0	3.0'	269	3.5	2.0	4.0	3.0'	814	2.1	1.4	2.0
	7.5'	240	3.1	3.1	7.5'	162	3.8	3.5	4.0	4.0'	143	4.6	2.9	5.0	4.0'	573	2.1	1.7	2.0
	10.0'	135	4.0	4.0	10.0'	92	5.1	4.5	5.0	5.0'	92	5.7	3.5	7.0	5.0'	340	2.8	2.5	3.0
	12.5'	87	5.1	5.1	12.5'	58	6.5	5.7	6.0	6.0'	65	7.0	4.2	8.0	6.0'	255	3.1	2.8	3.0
WIDE FLOOD	5.0'	284	3.3	3.3	5.0'	222	3.6	3.2	2.0	3.0'	191	3.2	2.7	3.0	3.0'	550	2.3	1.8	1.0
	7.5'	121	5.0	5.0	7.5'	95	5.4	5.1	3.0	4.0'	108	4.2	3.6	4.0	4.0'	283	3.3	3.1	2.0
	10.0'	67	6.6	6.6	10.0'	53	7.4	6.8	4.0	5.0'	69	5.5	4.6	5.0	5.0'	201	3.8	3.4	2.0
	12.5'	43	8.3	8.3	12.5'	34	9.2	8.6	5.0	6.0'	48	6.5	5.4	6.0	6.0'	138	4.6	4.3	2.0

# Light Module Dimming

Applies to: CMT4-HHP-LM, CMT4-C3M-LM



## PROJECT:

## TYPE:

### DIMMING COMPATIBILITY:

Amerlux® CMT fixtures are compatible with all major dimming protocols prevalent in the United States. Please see below for general compatibilities and wiring diagrams. Amerlux recommends testing your unique dimming configuration as the exact full configuration (Dimmer, Fixture Quantity, Voltage, etc) may affect dimming performance.

**--- NOTE: INFORMATION BELOW IS FOR WIRED DIMMERS ONLY. FOR WIRELESS DIMMERS, CONSULT FACTORY ---**

### TRIAC (Forward Phase) DIMMING (Standard)

Utilizes standard TRIAC dimmers that are in wide use in installations across the US. Best for retrofit applications where TRIAC dimmers are installed.

#### Notes:

- 120VAC or 277VAC\*
- Dims down to 5% light output (most cases)
- Consult Dimming manufacturer for installation instructions - DO NOT SHARE NEUTRALS!
- Must meet dimmer Minimum Load Requirements per dimming manufacturer

#### Compatible Dimmers†:

Wall Box (TRIAC 120VAC)	Central System
Lutron "Diva"	Lutron "GP" Panel
Lutron "Nova-T"	Lutron Grafik Eye QS
Lutron "Maestro"	
Lutron "Vareo"	
Lutron "Skylark"	

TRIAC Wiring Diagram

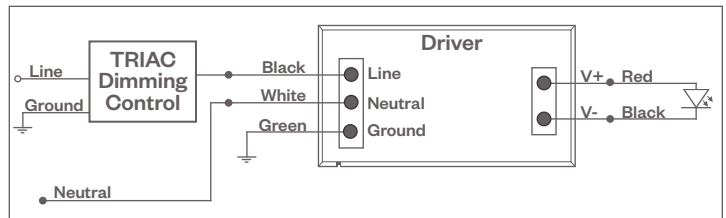

### ELV - Electronic Low Voltage (Reverse Phase) DIMMING (Standard)

Utilizes specialized "ELV" dimmers.

#### Notes:

- 120VAC or 277VAC\*
- Dims down to 5% light output (most cases)
- Consult Dimming manufacturer for installation instructions - DO NOT SHARE NEUTRALS!
- Must meet dimmer Minimum Load Requirements

#### Compatible Dimmers†:

Wall Box (ELV 120VAC)	Wall Box (ELV 277VAC)	Central System
Lutron "Diva"	Leviton Revoir II AWSMT-E	Lutron "GP" Panel with PHPM-PA 120/277VAC
Lutron "Nova-T"		Lutron Grafik Eye QS with PHPM-PA 120/277VAC
Lutron "Maestro"		
Lutron "Vareo"		
Lutron "Skylark"		
Leviton "Surslide"		
Leviton "Vizio"		

ELV Wiring Diagram

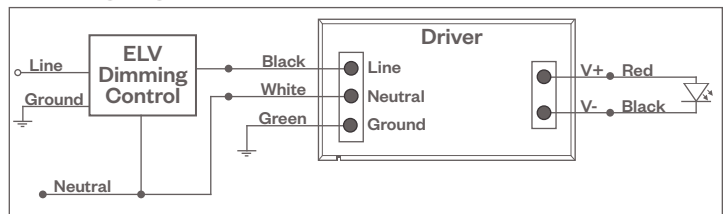

#### Notes:

- \* Driver is 277VAC dimmable with appropriate dimmer (by others). All provided wiring diagrams show 120VAC wiring colors and method. Please refer to 277VAC dimmer manufacturer installation instructions for 277VAC wiring diagrams.
- † The absence of a dimmer from the lists above does not imply incompatibility. Please consult factory for compatibility inquiries.

# Light Module Dimming

Applies to: CMT4-HHP-LM, CMT4-C3M-LM

## PROJECT:

## TYPE:

### DIMMING COMPATIBILITY:

Amerlux® CMT fixtures are compatible with all major dimming protocols prevalent in the United States. Please see below for general compatibilities and wiring diagrams. Amerlux recommends testing your unique dimming configuration as the exact full configuration (Dimmer, Fixture Quantity, Voltage, etc) may affect dimming performance.

**--- NOTE: INFORMATION BELOW IS FOR WIRED DIMMERS ONLY. FOR WIRELESS DIMMERS, CONSULT FACTORY ---**

### 0-10V DIMMING

Integrates into a variety of building management and daylighting controls

#### Notes:

- 120VAC or 277VAC\*
- Dims down to 1% light output
- Requires interface to turn off power to driver
- Consult Dimming manufacturer for installation instructions - DO NOT SHARE NEUTRALS!

#### 0-10V Wiring Diagram

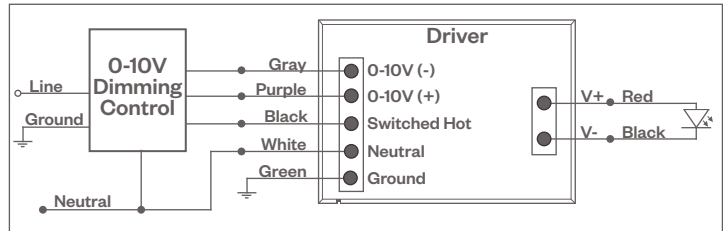

#### Compatible Dimmers\*:

##### Wall Box

Lutron "Diva" - DTVV with PP-120H Interface

Leviton Renoir II 0-10V

##### Central System

Lutron Grafik Eye with GRX-TV1 Interface

### LUTRON H-SERIES / ECOSYSTEM DIMMING

Integrates into Lutron EcoSystem building management

#### Notes:

- 120VAC or 277VAC\*
- Dims down to 1% light output
- EcoSystem Control
- Consult Dimming manufacturer for installation instructions - DO NOT SHARE NEUTRALS!

#### HILUME-H-ECO, HILUME-5-ECO

#### EcoSystem Digital Control Wiring Diagram

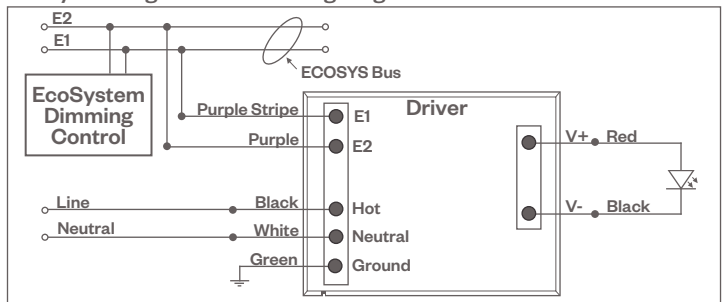

#### Compatible Dimmers\*:

##### Lutron ECO System

Pow Pak Dimming Modules  
Energj Savr Node  
Grafik Eye QS/Homeworks  
QS Control Unit  
Quantum Hub  
Homeworks QS/My Room

##### Central System

Lutron EcoSystem compatible controls

### DALI DIMMING

Digital control protocol allows individual fixture control

#### Notes:

- 120VAC - 277VAC\*
- Dims down to 1% light output in most cases

#### DALI Wiring Diagram

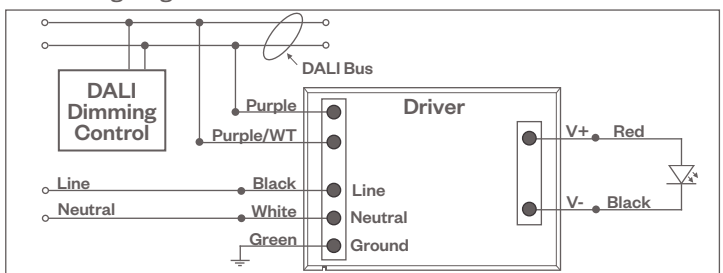

#### Compatible Dimmers\*:

##### Wall Box (3-Wire Fluorescent)

Leviton CD250 Controller

##### Central System

Dynalite  
Fifth Light

#### Notes:

- \* Driver is 277VAC dimmable with appropriate dimmer (by others). All provided wiring diagrams show 120VAC wiring colors and method. Please refer to 277VAC dimmer manufacturer installation instructions for 277VAC wiring diagrams.
- † The absence of a dimmer from the lists above does not imply incompatibility. Please consult factory for compatibility inquiries.