

Quick-Line

2" Pendant Direct

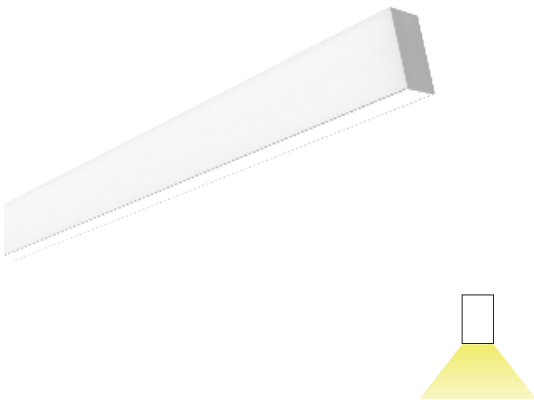

Features

Quick-Line 2" delivers your design scenario seamlessly, shipping in as little as 5 business days, everytime. Streamlined and flexible, these architectural LED pendants provide the freedom to create truly dynamic spaces in a fraction of the time. The **Quick-Line** family delivers on its promises by the power of disciplined design.

Product Overview

Type:	Direct
Power Level:	Low Power 4W/ft High Power 8W/ft
Max Lumen Output:	3,276 lm; 819 lm/ft
Color Temp:	3000K, 3500K, 4000K
CRI:	80 typ.
Lens:	Performance Lens
Dimming:	0-10V, 10% dimming
Construction:	Aluminum Extrusion
Weight:	2.25 lb/ft

PROJECT:

TYPE:

PRODUCT DISCONTINUED
Replacement Product: **Carisma 2" Direct**

Fixture Summary (see following pages for more information)

Power Level

	Watts Per Foot	Delivered Lumens	Lumens Per Foot	Lumens Per Watt
Low	4	1844	461	118.1
High	8	3276	819	106.3

Lumen Output based on 4', 3500K-80 fixture.

Individual Run Sections: 4', 6', 8'

Please use a combination of 4', 6', 8' standard lengths to create your desired run lengths.

Electrical Data

Wattage Per Foot	Volts	4'		6'		8'	
		System Watts	Amps	System Watts	Amps	System Watts	Amps
LOW 4W	120V	15.5	0.13	22.1	0.18	30.7	0.25
	277V	15.7	0.059	22	0.082	30.2	0.11
HIGH 8W	120V	30.7	0.25	46.4	0.38	60.8	0.50
	277V	30.3	0.11	45.9	0.17	60	0.22

Electronic multi-volt (120V-277V), constant current LED driver



PROJECT:

TYPE:

Ordering Reference

All fixtures come standard with the following:

- Performance Lens • High Reflectance White or Black Textured Finish • 1 Circuit (6 Conductor) • 120/277V • 0-10V, 10% Dimming

STEP 1 Choose Fixture: Select Power Level, Color Temp, Length & Finish

- **Select Power Level & Color Temperature:**

Power Level: **Low Power** – 4W/ft; 461 Lm/ft
High Power – 8W/ft; 819 Lm/ft

Color Temp: **30** – 3000K-80 (CRI)
35 – 3500K-80 (CRI)
40 – 4000K-80 (CRI)

- **Select Length(s):** 4', 6', or 8'

All lengths are pre-wired and supplied with 1 suspension gripper, alignment pins, light block shield, and Catch & Latch. End Caps ordered separately.

- **Emergency Fixtures (EMB):** have an integrated emergency driver & battery.

4EMB & 8EMB can replace standard 4' or 8' lengths (1 for 1) anywhere along the run without additional power feeds.

Cap orange lead for normal operation. EM battery lights entire length.

Please Note: For the EMB, **orange** lead must be wired to an unswitched hot power feed. A test pilot light is located on top of fixture. See drawing on page 4

STEP 2 Kits: Required for Assembly (see page 5 for drawings)

- **Select Appropriate Kits Needed to Complete Run** (see page 5 for complete kit details)

All Kits are packed individually in a labeled poly bag.

End Cap Kit: (needed for every run or individual section)

QLP2-EC: One Kit is required for every run. Consists of: 2 End Caps (White), cable gripper & instruction sheet. (Cable gripper is used with the first feed kit). **QLP2-ECBT** (black textured) optional.

Power Feed & Cable Kit:

QLK-FF110: Power Feed kit consist of 1 circuit (6 conductor) 10' power cord with female quick-connector, aircraft cable and 5" white canopy. Requires at least 1 for each run or individual fixture. **QLK-FF110BT** (black canopy/cord) optional. Order **QLK-FF120** for 20' cord/cable. **QLK-FF120BT** (black canopy/cord) optional.

Non-Feed Cable Kits:

QLK-SC10: One is required for every 4', 6' or 8' length. Consists of 10' aircraft cable, 5" white canopy, and hardware.

QLK-SC10BT (black canopy) optional. Order **QLK-SC20** for 20' cable. **QLK-SC20BT** (black canopy) optional.

STEP 3 Accessories: Optional (see page 5 for drawings)

Slotted J-Box Accessory:

QLP-SJB: For installation directly over GRID runners in ceiling system. T slotted J-Box works with both 9/16" and 15/16" GRID ceiling.

Alternate Side Power Feed & Cable Kit:

QLK-MF110: Alternate Side Power Feed kits consist of 1 circuit (6 conductor) 10' power cord with male quick-connector, aircraft cable and 5" white canopy. For use if run of fixtures requires second circuit to be fed from opposite end of run.

QLK-MF110BT (black canopy/cord) optional. Order **QLK-MF120** for 20' cord/cable. **QLK-MF120BT** (black canopy/cord) optional.

- ⚡ **Warning:** Through wiring must be disconnected and capped to separate the 2 circuits before power is supplied.

Emergency Circuits:

Emergency Circuits are easily added to any multi-lengths run at the beginning or end of run. Replace a Support Cable

(**QLK-SC10/QLK-SC20**) with **QLK-MF110/QLK-MF120** (Alt. side power feed) to feed from the right end or a **QLK-FF110/QLK-FF120** to feed from left end. See drawing on page 9.

QLK-SC10BT/QLK-SC20BT & QLK-MF110BT/QLK-MF120BT & QLK-FF110BT/QLK-FF120BT (black) optional.

- ⚡ **Warning:** Use supplied black plug to Dead End last length before adding second feed.

Additional Circuits:



Circuits can be added to any multi-length run for Zonal Lighting, or for remote sensor control.

- ⚡ **Warning:** Use dead end caps on Quick Connects to separate zones prior to turning power on to prevent injury.

PROJECT:

TYPE:

STEP 1 Choose Fixture: Select Power Level, Color Temp, Length & Finish

Power Level	Color Temp-CRI	Length	Ordering Part #	
			White Finish	Black Finish
Low Power (4 W/ft; 461 Lm/ft) 	30 (3000K-80)	4'	QLP2-001	QLP2-006
		4' EMB	QLP2-002	QLP2-007
		6'	QLP2-003	QLP2-008
		8'	QLP2-004	QLP2-009
		8' EMB	QLP2-005	QLP2-010
	35 (3500K-80)	4'	QLP2-011	QLP2-016
		4' EMB	QLP2-012	QLP2-017
		6'	QLP2-013	QLP2-018
		8'	QLP2-014	QLP2-019
		8' EMB	QLP2-015	QLP2-020
	40 (4000K-80)	4'	QLP2-021	QLP2-026
		4' EMB	QLP2-022	QLP2-027
		6'	QLP2-023	QLP2-028
		8'	QLP2-024	QLP2-029
		8' EMB	QLP2-025	QLP2-030
High Power (8W/ft; 819 Lm/ft) 	30 (3000K-80)	4'	QLP2-031	QLP2-036
		4' EMB	QLP2-032	QLP2-037
		6'	QLP2-033	QLP2-038
		8'	QLP2-034	QLP2-039
		8' EMB	QLP2-035	QLP2-040
	35 (3500K-80)	4'	QLP2-041	QLP2-046
		4' EMB	QLP2-042	QLP2-047
		6'	QLP2-043	QLP2-048
		8'	QLP2-044	QLP2-049
		8' EMB	QLP2-045	QLP2-050
	40 (4000K-80)	4'	QLP2-051	QLP2-056
		4' EMB	QLP2-052	QLP2-057
		6'	QLP2-053	QLP2-058
		8'	QLP2-054	QLP2-059
		8' EMB	QLP2-055	QLP2-060

STEP 2 Kits: Required for Assembly (see page 5 for drawings)

Kit	Description	Ordering Part #	
		White Finish	Black Finish
End Cap Kit:			
End Cap	End Cap Kit for Direct & Direct/Indirect fixtures (1 per run)	QLP2-EC	QLP2-ECBT
Feed Kits:			
Power Feed & Cable Kit	10' power cable, 5" canopy, 1 circuit (6 conductor) power cord	QLK-FF110	QLK-FF110BT
	20' power cable, 5" canopy, 1 circuit (6 conductor) power cord	QLK-FF120	QLK-FF120BT
Non-Feed Cable Kit:			
Support Cable	10' aircraft cable, 5" canopy & hardware	QLK-SC10	QLK-SC10BT
	20' aircraft cable, 5" canopy & hardware	QLK-SC20	QLK-SC20BT

STEP 3 Accessories: Optional (see page 5 for drawings)

Accessory	Description	Ordering Part #	
		White Finish	Black Finish
J-Box Accessory:			
Slotted J-Box	Slotted J-Box (needed for feed & non-feed kits over GRID runner)	QLP-SJB	QLP-SJB
Optional Feed Kit:			
Alternate Side Power & Cable Kit	10' power cable, 5" canopy, 1 circuit (6 conductor) power cord	QLK-MF110	QLK-MF110BT
	20' power cable, 5" canopy, 1 circuit (6 conductor) power cord	QLK-MF120	QLK-MF120BT

For Emergency Circuits/Additional Circuits: Order either a Power Feed & Cable Kit (QLK-FF110/QLK-FF120) or an Alternate Side Power Feed & Cable Kit (QLK-MF110(BT)/QLK-MF120(BT) QLK-MF110(BT)) to replace the Non-Feed Support Cable Kit (QLK-SC10(BT)/QLK-SC20(BT)) anywhere along the run. See page 9 for more detail.

Note: There are no product variations available from standard product offering for this product line.

Quick-Line

2" Pendant Direct



Quick-Line 2" Direct

PROJECT:

TYPE:

Quick-Line 2" Direct

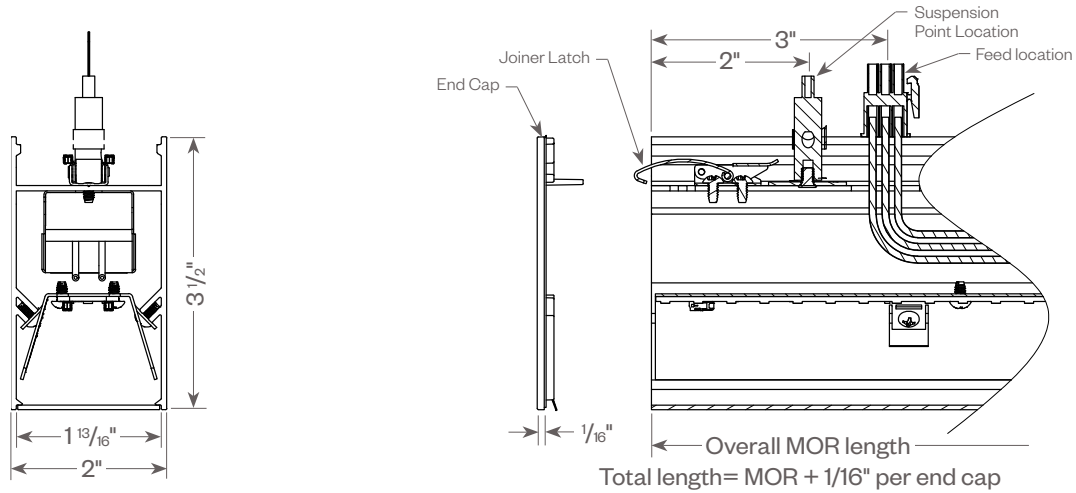

QUICK CONNECT ALIGNMENT

Plug together Quick connects. Line up the two housings by using the alignment pins & splines. Secure them together by using the Catch & Latch system on the top of the extrusion. Finish run or individual section by securing end caps.

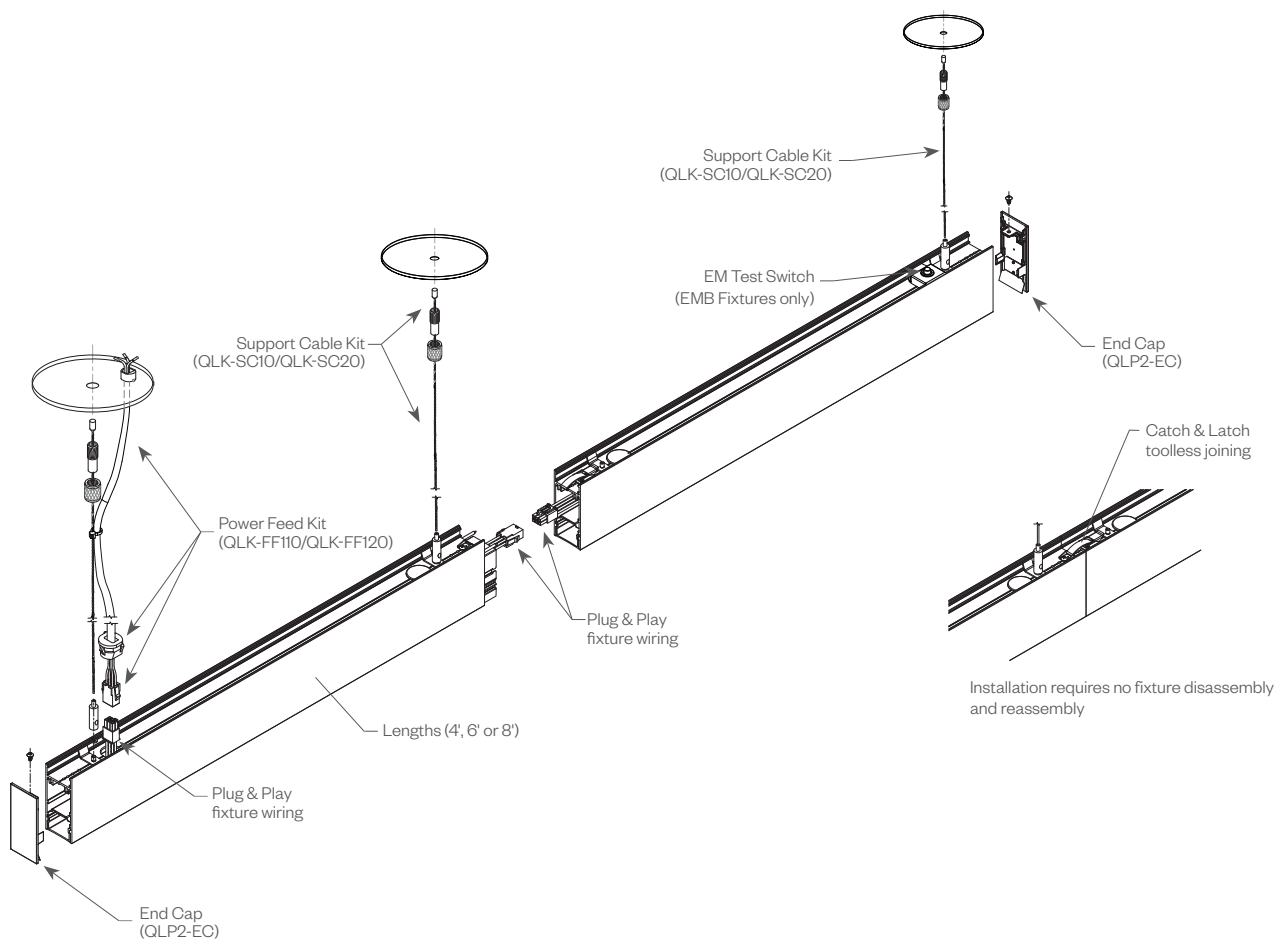

PROJECT:

TYPE:

Quick-Line Kits:

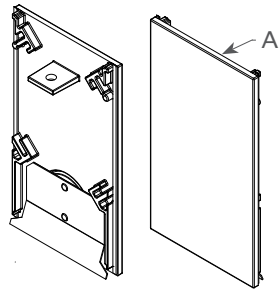

End Cap Kit (QLP2-EC)

Use: On all single and multiple runs. Field installed on the first and last fixture end of the run.

Consisting of:

- A - (2) End Caps with locking screws
- B - (1) Cable Gripper*
- (1) Instruction Sheet

Order **QLP2-ECBT** for black texture finish.

*** Note:** One Gripper is factory installed on right side of length for use with **QLK-SC10** or **QLK-SC20** support cable kit. 2nd Gripper is supplied with End Cap Kit and is to be used with beginning feed kit (**QLK-FF110/QLK-FF120**).

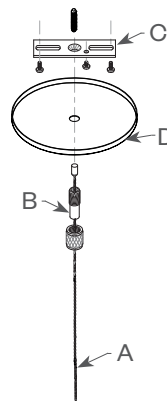

Non-Feed Cable Kit (QLK-SC10)

Use: Support Cable Kit, 10' long, non-feed. 1 used on every length.

Consisting of:

- A - (1) 10' cable
- B - (1) Cable Coupler (ferruled for j-box access)
- C - Cross bar and hardware
- D - (1) 5" White steel Canopy (single hole in center)
- (1) Instruction sheet

Order **QLK-SC20** for 20' cable.

Order **QLK-SC10BT**, **QLK-SC20BT** for black canopy finish.

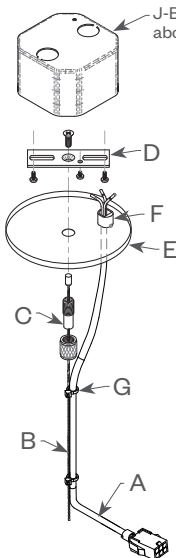

Power Feed & Cable Kit (QLK-FF110)

Use: For pendant, starting and typically only feed dead end plug provided for safety and quick installation. Usually just 1 used on every run.

Consisting of:

- A - (1) 10' 6 conductor white drop cord, female quick connect plug with strain relief
- B - (1) 10' cable
- C - (1) Cable Coupler (ferruled for j-box access)
- D - Cross bar and hardware
- E - (1) 5" White steel Canopy
- F - (1) White strain-relief fitting
- G - (10) Wire ties
- (1) Instruction sheet

Order **QLK-FF120** for 20' cord/cable.

Order **QLK-FF110BT**, **QLK-FF120BT** for black canopy/cord.

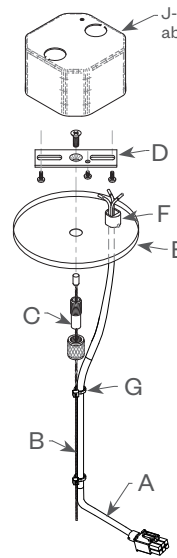

Alternate Side Power Feed & Cable Kit (QLK-MF110)

Use: For pendant when second feed is required or feeding run from alternate side. Alternate Side plug and black dead end plug provided for safety and quick installation.

Consisting of:

- A - (1) 10' 6 conductor white drop cord, male quick connect plug with strain relief
- B - (1) 10' cable
- C - (1) Cable Coupler (ferruled for j-box access)
- D - Cross bar and hardware
- E - (1) 5" White steel Canopy
- F - (1) White strain-relief fitting
- G - (10) Wire ties
- (1) Instruction sheet

Order **QLK-MF120** for 20' cord/cable.

Order **QLK-MF110BT**, **QLK-MF120BT** for black canopy/cord.

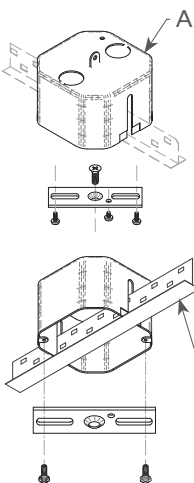

Slotted J-Box Accessory (QLP-SJB)

Use: For any installation direct over T runners in ceiling grid system. T slotted J-Box works with both 9/16" and 15/16" GRID ceiling systems. Order (1) SJB for every suspension point. Other solutions available for non-feed cable hangers in grid ceilings.

Consisting of:

- A - (1) Slotted J-Box (note: all other J-Boxes are supplied by others).

Drop ceiling T-bar (by others) for drop ceiling applications.

PROJECT:

TYPE:

FIXTURE DATA: (Complete photometric data (.ies format) available on website)

MULTIPLYING FACTORS: (Multiplying Factor is based on 3500K-83 120V IES file on website)

CCT:	3000K-83	3500K-83	4000K-83
Factor:	0.97	1.0	1.01

QLP2 DIRECT PERFORMANCE LENS 4W 3500K 4FT

Total Watts: 16 (LOW POWER)
 Total Lumens: 1,844 lm
 Source: 112 White LED's

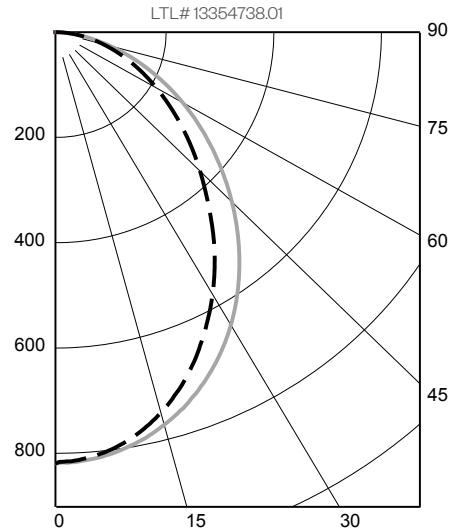

ZONAL LUMEN SUMMARY

Zone	Lumens	% of Fixt
0-40	938	50.9
0-60	1520	82.4
0-90	1845	100.0
90-180	0	0

Efficacy = 118.1 Lumens / Watt

COEFFICIENTS OF UTILIZATION

Effective Floor Cavity Reflectance 20%

RC	RC			
	70	50	30	10
RCR				
0	119	119	119	119
1	109	105	101	97
2	100	92	86	80
3	92	82	74	68
4	84	73	65	58
5	78	66	57	51
6	72	59	51	45
7	67	54	46	40
8	63	50	41	36
9	59	46	38	32
10	55	42	35	30

Values are expressed as percent of total lumen output delivered to the task surface.

CONE OF LIGHT TABULATION

Mounting Height	Footcandles @ Nadir	Diameter (feet)
4'	51.2	4.48
6'	22.8	6.72
8'	12.8	8.96
10'	8.20	11.2
12'	5.69	13.4
14'	4.18	15.7
16'	3.20	17.9v

QLP 2 DIRECT PERFORMANCE LENS 8W 3500K 4FT

Total Watts: 31 (HIGH POWER)
 Total Lumens: 3,276 lm
 Source: 112 White LED's

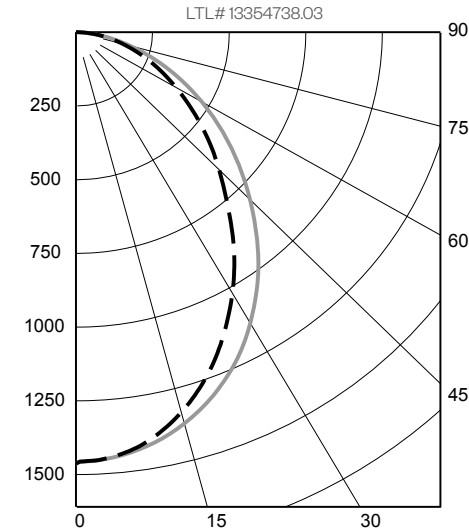

ZONAL LUMEN SUMMARY

Zone	Lumens	% of Fixt
0-40	1670	51.0
0-60	2701	82.4
0-90	3275	100.0
90-180	0	0

Efficacy = 106.3 Lumens / Watt

COEFFICIENTS OF UTILIZATION

Effective Floor Cavity Reflectance 20%

RC	RC			
	70	50	30	10
RCR				
0	119	119	119	119
1	109	105	101	97
2	100	92	86	80
3	92	82	74	68
4	84	73	65	58
5	78	66	57	51
6	72	60	51	45
7	67	54	46	40
8	63	50	42	36
9	59	46	38	33
10	55	42	35	30

Values are expressed as percent of total lumen output delivered to the task surface.

CONE OF LIGHT TABULATION

Mounting Height	Footcandles @ Nadir	Diameter (feet)
4'	91.5	4.47
6'	40.6	6.71
8'	22.9	8.95
10'	14.6	11.2
12'	10.2	13.4
14'	7.47	15.7
16'	5.72	17.9

Quick-Line

2" Pendant Direct



PROJECT:

TYPE:

DIMMING COMPATIBILITY:

Amerlux® Quick-Line fixtures are compatible with 0-10V Dimming. Please see below for general compatibilities and wiring diagrams. Amerlux recommends testing your unique dimming configuration as the exact full configuration (Dimmer, Fixture Quantity, Voltage, etc) may affect dimming performance.

0-10V - DIMMING (Standard)

Integrates into a variety of building management and daylighting controls

0-10V Wiring Diagram

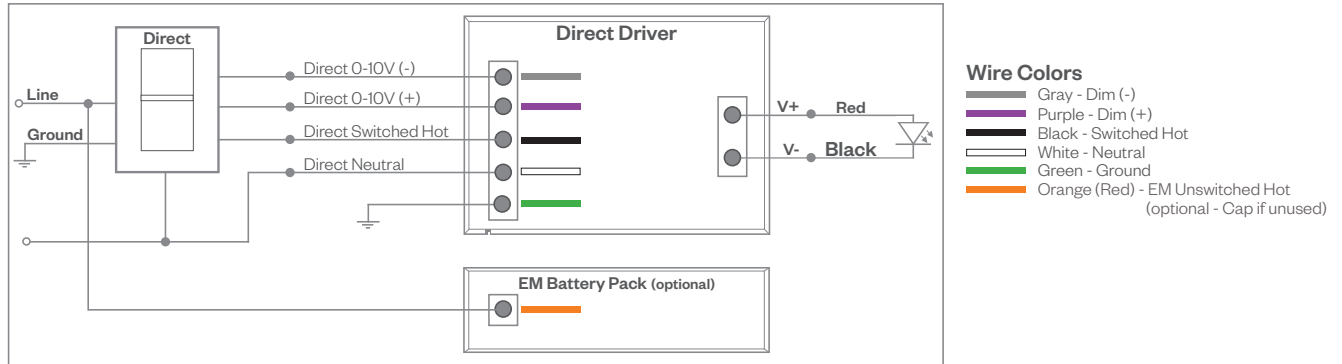

Notes:

- 120V or 277V*
- Dims down to 10% light output
- Requires interface to turn off power to driver
- Consult Dimming manufacturer for installation instructions - **Do Not Share Neutrals**
- Daylighting runs may require standard and alternate side power feeds

Compatible Dimmers†:

Wall Box

Lutron:	Wattstopper:	Leviton:
Diva - DVSTV	ADF-120277	Renoir II
Maestro - MS-Z101		
Nova-T - NTSTV-DV		

Centralized Dimming Control System

Lutron Grafikx Eye with GRX-TV1 Interface

Notes:

- * Driver is 277V dimmable with appropriate dimmer (by others). All provided wiring diagrams show 120V wiring colors and method. Please refer to 277V dimmer installation instructions for 277V wiring diagrams.
- † The absence of a dimmer from the lists above does not imply incompatibility. Please consult factory for compatibility inquiries.

PROJECT:

TYPE:

SINGLE LENGTHS / RUNS

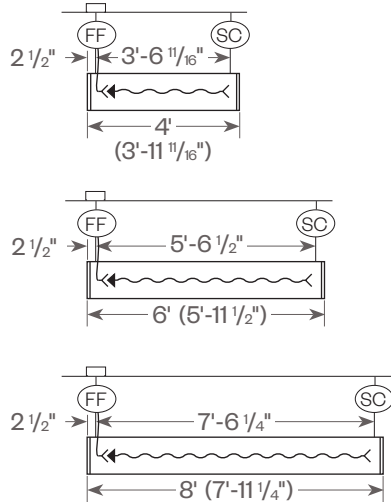

Key:

- ⊙ (SC) = Support Cable (QLK-SC10), Non-Feed, 10'
- ⊙ (FF) = Power Feed (QLK-FF110) Cable Kit, 10', 1 cir.
- ⊙ (MF) = Alt. Power Feed (QLK-MF110) Cable Kit, 10', 1 cir.
- ⊥ = End Cap (QLP2-EC) Kit
- ← = Male Quick Connect Plug (for wire harness)
- ↔ = Female Quick Connect Plug (for wire harness)
- = Feed J-Box location

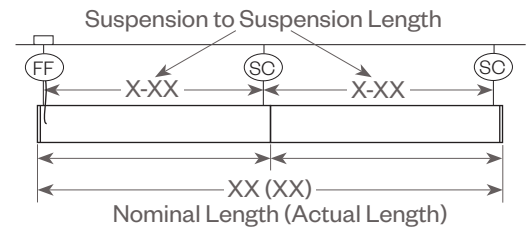

MULTI-LENGTH RUNS

8' Lengths

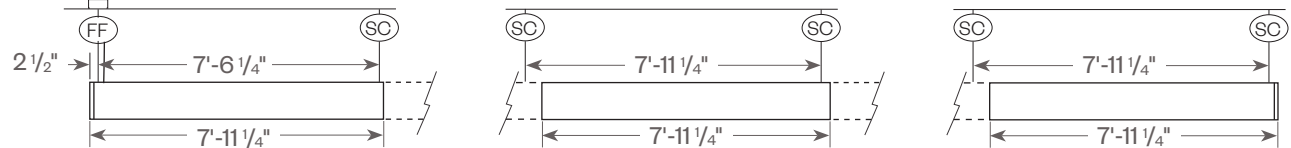

6' Lengths

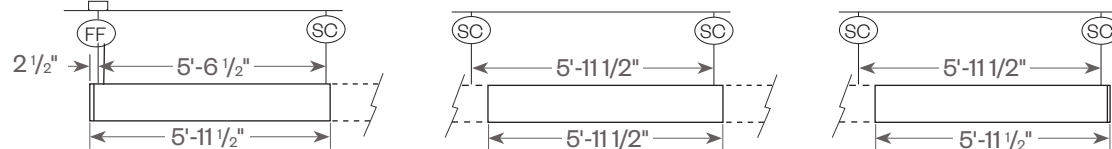

4' Lengths

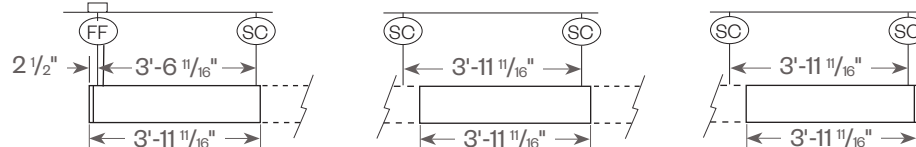

Note: Customer is responsible for all measurements, feed locations and field conditions.

DIRECT VOLTAGE DROPS

Recommended 2nd Power Feed:

Low Power Level

120 Volts 4W/ft - 150' second drop
277 Volts 4W/ft - 345' second drop

High Power Level

120 Volts 8W/ft - 85' second drop
277 Volts 8W/ft - 195' second drop

PROJECT:

TYPE:

OPTIONAL EMERGENCY CIRCUITING:

EMERGENCY CIRCUIT AT END

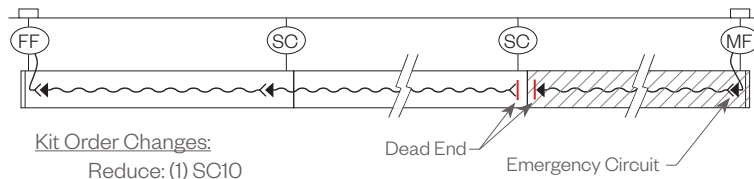

Kit Order Changes:
 Reduce: (1) SC10
 Add: (1) **MF110** (at end of run)

Key:

- ⊙(SC) = Support Cable (**QLK-SC10**), Non-Feed, 10'
- ⊙(FF) = Female Feed (**QLK-FF110**) Cable Kit, 10', 1 cir.
- ⊙(MF) = Male Feed (**QLK-MF110**) Cable Kit, 10', 1 cir.
- ⊥ = End Cap (**QLP2-EC**) Kit
- ◀ = Male Quick Connect Plug (for wire harness)
- ↔ = Female Quick Connect Plug (for wire harness)
- | = Dead end
- ▭ = Feed J-Box location

EMERGENCY CIRCUIT IN MIDDLE

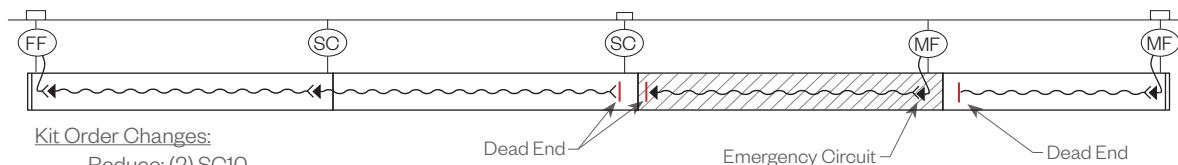

Kit Order Changes:
 Reduce: (2) SC10
 Add: (1) **MF110** (at end of run) & (1) **FF110** (in middle or run)

EMERGENCY CIRCUIT AT BEGINNING

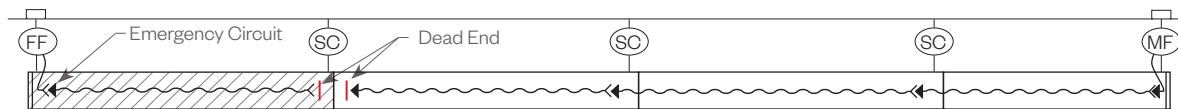

Kit Order Changes:
 Reduce: (1) SC10
 Add: (1) **MF110** (at end of run)

ZONAL LIGHTING

Note: Additional circuits can be added as needed. Use dead end plugs (black) to safely end circuits.

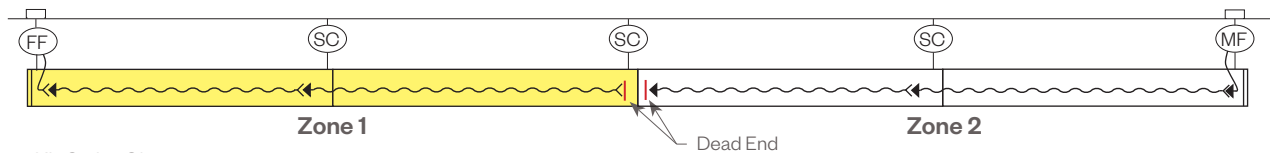

Kit Order Changes:
 Reduce: (1) SC10
 Add: (1) **MF110** (at end of run)

EMERGENCY (ED-BATX) DRIVER WITH BATTERY

Note: No additional feed needed. Can be installed anywhere along run. Substitute 4' or 8' with 4EMB or 8EMB
 Must wire orange conductor to unswitched Hot.

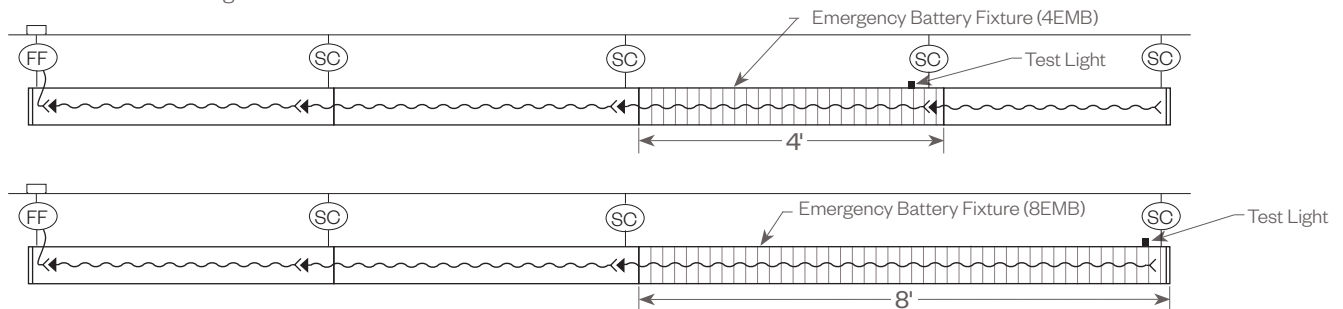

PROJECT:

TYPE:

APPLICATION DATA:

Private Office:

Room Size: 12' x 10' (120 ft²)
 Ceiling Height: 8' 6"
 Fixture Mounting: 7' mh (top of fixture)
 LLF: 0.78

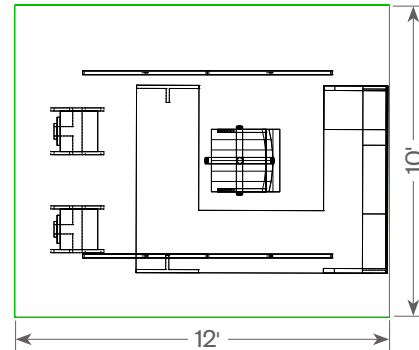

Model	Performance Profile (3500K)	8' Runs	Total Wattage	Avg Illumination (fc) on workplane	Ceiling Uniformity (max/min ratio)	Lighting Power Density (W/ft ²)
QLP2 Direct	LOW (461 Lm/ft)	2 Runs 6' O.C.	63	36	2.31	0.52
QLP2 Direct	HIGH (819 Lm/ft)	2 Runs 6' O.C.	124	64	2.32	1.02

Small Conference Room:

Room Size: 12' x 16' (192 ft²)
 Ceiling Height: 8' 6"
 Fixture Mounting: 7' mh (top of fixture)
 LLF: 0.78

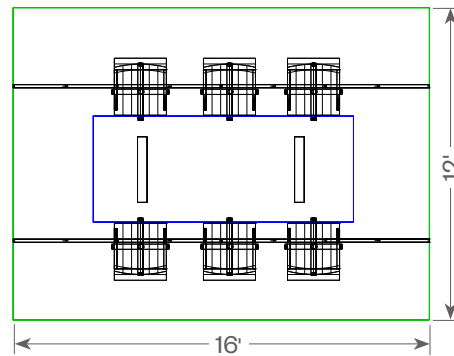

Model	Performance Profile (3500K)	12' Runs	Total Wattage	Avg Illumination (fc) on work plane	Ceiling Uniformity (max/min ratio)	Lighting Power Density (W/ft ²)
QLP2 Direct	LOW (461 Lm/ft)	2 Runs 6' O.C.	125	45	2.27	0.65
QLP2 Direct	HIGH (819 Lm/ft)	2 Runs 6' O.C.	247	80	2.26	1.28

PROJECT:

TYPE:

APPLICATION DATA:

Large Open Office:

Room Size: 50' x 50' (2,500 ft²)
 Ceiling Height: 9'
 Fixture Mounting: 7' 6" mh (top of fixture)
 LLF: 0.78

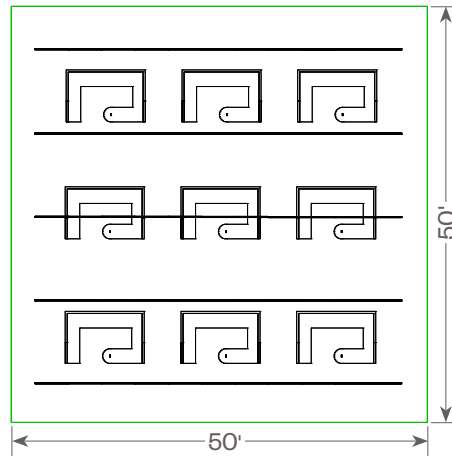

Model	Performance Profile (3500K)	44' Runs	Run Wattage	Total Wattage	Avg Illumination (fc) on work plane	Ceiling Uniformity (max/min ratio)	Lighting Power Density (W/ft ²)
QLP2 Direct	LOW (461 Lm/ft)	5 Runs 10' O.C.	172	859	27	3.77	0.34
QLP2 Direct	HIGH (819 Lm/ft)	5 Runs 10' O.C.	339	1,694	47	3.74	0.68
QLP2 Direct	LOW (461 Lm/ft)	6 Runs 8' O.C.	172	1,031	32	3.70	0.41
QLP2 Direct	HIGH (819 Lm/ft)	6 Runs 8' O.C.	339	2,033	57	3.68	0.81

Classroom:

Room Size: 38' x 24' (912 ft²)
 Ceiling Height: 12'
 Fixture Mounting: 10' 6" mh (top of fixture)
 LLF: 0.78

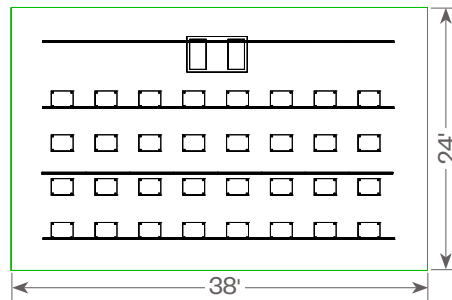

Model	Performance Profile (3500K)	32' Runs	Run Wattage	Total Wattage	Avg Illumination (fc) on work plane	Ceiling Uniformity (max/min ratio)	Lighting Power Density (W/ft ²)
QLP2 Direct	LOW (461 Lm/ft)	4 Runs 6' O.C.	125	500	45	2.07	0.55
QLP2 Direct	HIGH (819 Lm/ft)	4 Runs 6' O.C.	247	986	80	2.07	1.08