



AMERLUX[®]
LIGHTING SOLUTIONS

ADAPT. ABILITY.™

INSTALLATION INSTRUCTIONS
SHEET #: 689-1039

SPEC. SHEET
REFERENCE:
QLP2-EC

QLP2-EC

QLP2.0 End Cap Kit Installation

WARNING - RISK OF FIRE AND ELECTRICAL SHOCK. FIXTURE MUST BE INSTALLED BY A QUALIFIED ELECTRICIAN ONLY. FIXTURE IS INTENDED FOR INSTALLATION IN ACCORDANCE WITH THE NATIONAL ELECTRICAL CODE, LOCAL AND FEDERAL SPECIFICATIONS. DISCONNECT POWER AT ELECTRICAL PANEL BEFORE SERVICING.

RETAIN THESE INSTRUCTIONS FOR MAINTENANCE REFERENCE.

Pre-installation Note:

The actions outlined on this sheet are to be performed before fixture is hung, while still on the ground.

QLP2-EC Contents

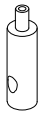

Cable Gripper (x1)
Amerlux P/N: 636-7060



#6 x 1/4" Screw (x2)
Amerlux P/N: 622-3022

End Cap (x2)
Amerlux P/N: 610-0661G-HW OR 610-0661G-BT

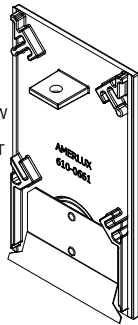

Lock Washer (x1)
Amerlux P/N: 648-0140

Fixture MoR (Sold / Shipped Separately)

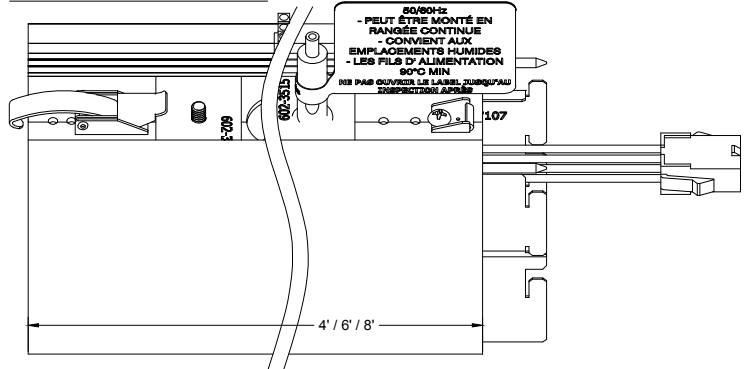

Creating a Beginning of Run (BoR)

1: Remove Latch
Via (2) Screws. Discard.

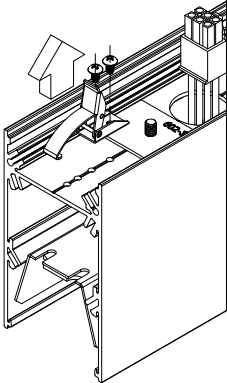

2: Install Cable Gripper
Make sure gripper is tightly secured.

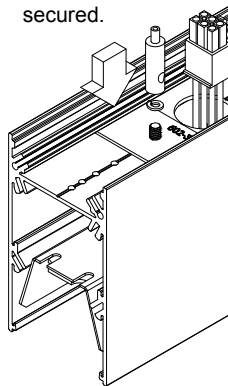

3: Install End Cap
A. Remove adhesive strip's non-stick covers

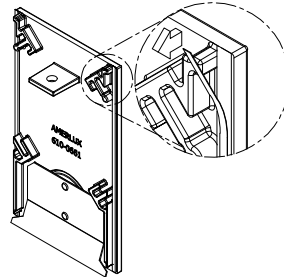

INSTALL POWER FEED BEFORE END CAP

See INSTRUCTIONS (Located in Feed Kit)

B. Firmly attach end cap

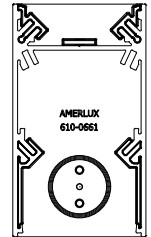
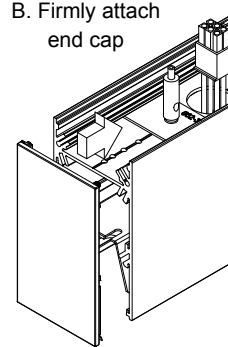

Embossments on end cap to line up with extrusion profile as shown

Complete BoR

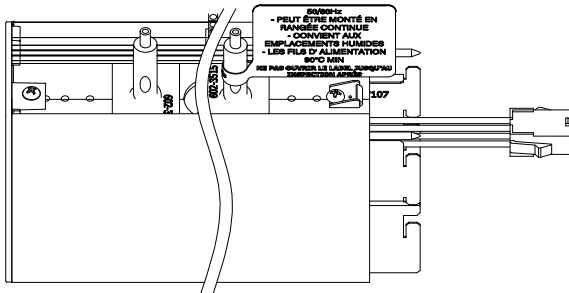

C. Secure end cap with provided #6-32x1/4 screw*

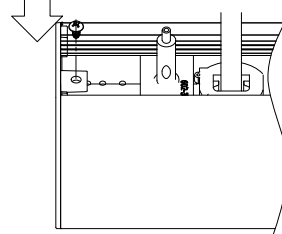

* DO NOT over tighten screw. Hand Tightening is recommended. (Over tightening will cause bottom of end cap to separate from fixture)

Correct
End cap should sit flush with side of housing extrusion as shown

Incorrect
If End Cap separates as shown, loosen screw until it sits flush



Creating an End of Run (EoR)

1: Remove Shields & Pins

Using pliers, remove all (3) light leak shields and (2) alignment pins. Discard.

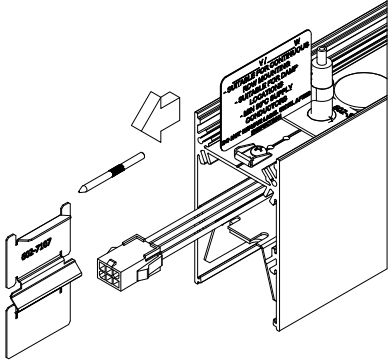

2: Remove Catch

Via (1) Screws. Discard.

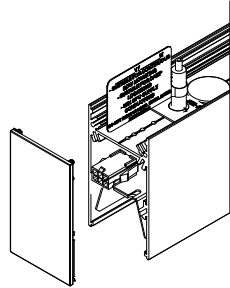

3: Install End Cap

A. Remove adhesive strip's non-stick covers

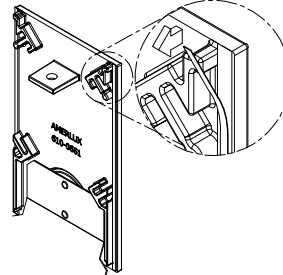

INSTALL POWER FEED BEFORE END CAP

SEE INSTRUCTIONS
(Located in Feed Kit)

B. Firmly attach end cap

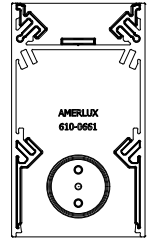
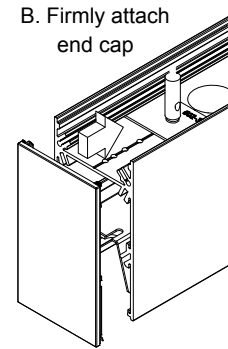

Embossments on end cap to line up with extrusion profile as shown

C. Secure end cap with provided #6-32x $\frac{1}{4}$ screw*

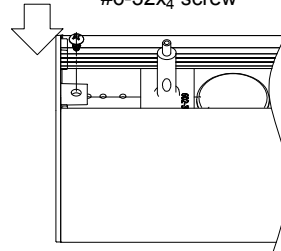

* **DO NOT** over tighten screw.
Hand Tightening is recommended.
(Over tightening will cause bottom of end cap to separate from fixture)

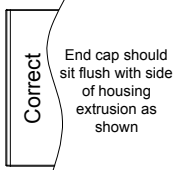

Correct
End cap should sit flush with side of housing extrusion as shown

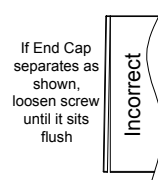

Incorrect
If End Cap separates as shown, loosen screw until it sits flush

Complete EoR

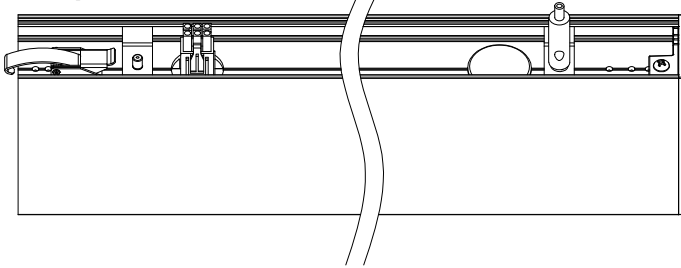

Creating an Individual (IND)

To create an IND fixture, please follow ALL steps from BoR & EoR creation

Complete IND

