

Producer Combo

Linear LED with Track



(shown with Amerlux SPEQ-S track head, sold separately)

Features

The Producer-Combo is a linear LED pendant with track sections. At 10 watts per foot, it features a high efficient 60° or 80° batwing distribution, providing the right amount of light for your shelving displays. For more general illumination applications, a symmetrical distribution is offered. Available in 4'/6'/8' (standard) lengths, the Producer-Combo offers various color temperatures, an optional 20% uplight component, as well as 0-10V dimming. The Producer-Combo is an ideal choice for aisle or general lighting with the need for accent lighting in supermarkets.

Product Overview

Type: Direct, Symmetrical or Batwing Lens, Louver
 Wattage: 5W/ft, 10W/ft (other wattages consult factory)
 Lumen Output: 5,016 max; 132.4 Lm/W (10W, BAT60, 4ft fixture)
 Color Temp: 2700K, 3000K, 3500K, 4000K
 CRI: 83 typ. or 90+ typ
 Dimming: 0-10V, 1% dim (standard)
 Lutron LDE1 Hi-lume® 1% Soft-On/Fade-to-Black
 DALI dimming, 1% dim

PROJECT:

TYPE:

Fixture Summary *(see following pages for more information)*

Performance Chart

Wattage Per Foot	Delivered Lumens	LPW	Color Temp - CRI
5	2508	125.4	3500K-83
10	5016	132.4	3500K-83

*Data is based on 3500K-83 IES files available on website
 Data is based on 4' fixture with 60° Batwing lens*

Runs

Individual Runs: 2' - 8' *(whole foot standard)*
 Continuous Runs: Available *(whole foot standard)*

Electrical Data

Wattage Per Foot		4'		8'	
		System Watts	Amps	System Watts	Amps
5	120V	22.3	0.18	41.9	0.35
	277V	22.9	0.09	41.6	0.16
10	120V	42.1	0.35	84.2	0.70
	277V	41.5	0.15	83.0	0.30

Electronic multi-volt (120-277VAC), constant current LED driver



Producer Combo

Linear LED with Track



PROJECT:

TYPE:

Ordering Information



1 Model
PROD-COMBO

2 Direct Optics

(Total Feet of Optic)	x	(Optic)
# of Feet		BAT60 - batwing 60° BAT80 - batwing 80° DL - designer lens

3 Track

(Total Feet of Track)	x	(Track)
# of Feet		1CT - Contech track, 1 circuit

2' minimum track section

4 Mounting

- Pendant Mount (aircraft cable suspension)
- ASW10** - through ceiling tile or gyp board, white, 10'
 - ASW20** - through ceiling tile or gyp board, white, 20'
 - ASB10** - through ceiling tile or gyp board, black, 10'
 - ASB20** - through ceiling tile or gyp board, black, 20'
 - ASW10T** - over ceiling tee, white, 10'
 - ASW20T** - over ceiling tee, white, 20'
 - ASB10T** - over ceiling tee, black, 10'
 - ASB20T** - over ceiling tee, black, 20'
 - 1420P** - mounting plate gripper with 1/4"-20 x 3/8" stud, power feed by others

5 Wattage (per foot)

- Standard:
- 5** - 5W/ft
 - 10** - 10W/ft
- Optional:
- 3** - 3W/ft
 - 4** - 4W/ft
 - 6** - 6W/ft
 - 7** - 7W/ft
 - 8** - 8W/ft
 - 9** - 9W/ft

6 Color Temp

83 CRI:	90+ CRI
27 - 2700K-83	279 - 2700K-90+
30 - 3000K-83	309 - 3000K-90+
35 - 3500K-83	359 - 3500K-90+
40 - 4000K-83	409 - 4000K-90+

7 Finish

- HW** - high reflectance matte white
 - BT** - black texture
 - ST** - silver texture
- For other RAL color, consult factory*

8 Voltage

- 120**
- 120/277**

9 Length

(Total = #2 + #3)

10 Configuration

- IND** - individual lengths, 4', 6' or 8' lengths
- CON** - continuous run, greater than 8'

11 Drivers

- 0-10V** - 1% electronic dimming , multi-volt (120-277VAC) constant current driver (standard)
- HILUME-H-ECO** - Lutron LDE1 Hi-lume® 1% Soft-On/Fade-to-Black
- DALI** - DALI Dimming 120-277VAC, 1% dim

12 Options

- LVRHW** - straight blade louver, high reflectance white
- LVRBT** - straight blade louver, black texture
- LVRST** - straight blade louver, silver texture
- (Louvers are used in conjunction with lens)*
- UL** - uplight (20%)
- UL8** - uplight (8%)
- ENLS** - Enlighted Sensor (0-10V driver only)
- PF²** - Extra power feed for emergency circuit or additional circuiting
- EMB** - emergency battery pack (not available for lengths under 4')
- EMC-PF** - emergency circuit requires power feed located in last fixture section (for other locations consult factory)

Producer Combo

Linear LED with Track



PROJECT:

TYPE:

Specifications

Application

Pendant direct symmetric or batwing lens distribution for aisle, shelving or general ambient lighting. Optional 20% uplight component adds a feeling of volume to the space. Track sections also available to incorporate Accent lighting for highlighting display areas.

Construction

One piece extruded aluminum housing. Die-cast End Plates match fixture body finish. Die-formed, cold-rolled steel internal components are protected against rust and corrosion. Dual Wire Way wiring chassis.
1 circuit Contech track. (Track Heads sold separately)

Optical

All lenses are snap-in, extruded acrylic, with a maximum length of 8'.

DL - Designer Lens provides flat even glow on lens. Best when lens is in direct or constant view. Such as vertical wall mounted.

BAT60 - 60° batwing distribution for wide light distribution.

BAT80 - 80° batwing distribution for very wide light distribution.

Optional:

UL - Optional uplight component (12" every 4'-0"). Shares driver with downlight component and creates an 80% down/20% up fixture. (Wattage remains constant)

UL8 - Optional uplight component (4" every 4'-0"). Shares driver with downlight component and creates an 92% down/8% up fixture. (Wattage remains constant)

LED

Amerlux's boards and patented connector design with brand name LEDs enables Amerlux fixtures to have excellent thermal management and offer a 5 year warranty. Our LED binning is within 3 MacAdam ellipse. Boards are configured for maximum flexibility resulting in even illumination no matter what the fixture layout. LED boards are easily replaced in the field with just a Phillips screw driver.

Color Temperature Options:

2700K, 3000K, 3500K, 4000K

CRI: 83 typical, 90+ typical

R9: 16 @ CRI 83

R9: >50 @ CRI 92

Life: 50,000+ hr., > 70% of initial lumens (L70)

Electrical

LED = Line 1, Track = Line 2

Wiring: Individual and "Beginning of Run" (BOR) fixtures are prewired with power cord. All configurations have quick connect power harnesses for row connections.

Standard Wattage: 5W/ft, 10W/ft.

Optional Wattages: 3W/ft, 4W/ft, 6W/ft, 7W/ft, 8W/ft, 9W/ft. (3W & 4W have a minimum length of 4'). For other wattages consult factory.

Emergency circuit via remote inverter or auxiliary emergency power supply (by others).

This product complies with IEEE C62.41 for surge endurance up to 2.5KV. Amerlux® recommends using additional surge protection with this unit (supplied by others), surge over voltage damage is not covered under warranty.

PF - power feed

2PF - two power feeds, one for LED section and one for track section

EMB - Emergency battery pack

Finish

All painted surfaces are premium powder coated baked on for maximum durability and color stability.

HW - High reflective matte White

BT - Black Texture

ST - Silver Texture

For special paint colors supply RAL and/or actual paint chip for factory consultation.

Mounting

Intended to be pendant mounted Individual fixtures or in continuous rows.

Cable Suspension: Cable is stranded stainless steel wire. All fittings are protected against rust and corrosion. Canopies are 5" x 1/4" die formed painted steel. Adjustment mechanism allows for infinite height adjustment. Amerlux recommends the required feed and non-feed suspensions based upon length and electrical options.

Certifications

Approved to UL standards for damp locations as tested by CSA.

Intended for indoor use only

Warranty

Amerlux's 5 year limited warranty. Please consult Amerlux website for details.

Producer Combo

Linear LED with Track



PROJECT:

TYPE:

PRODUCER

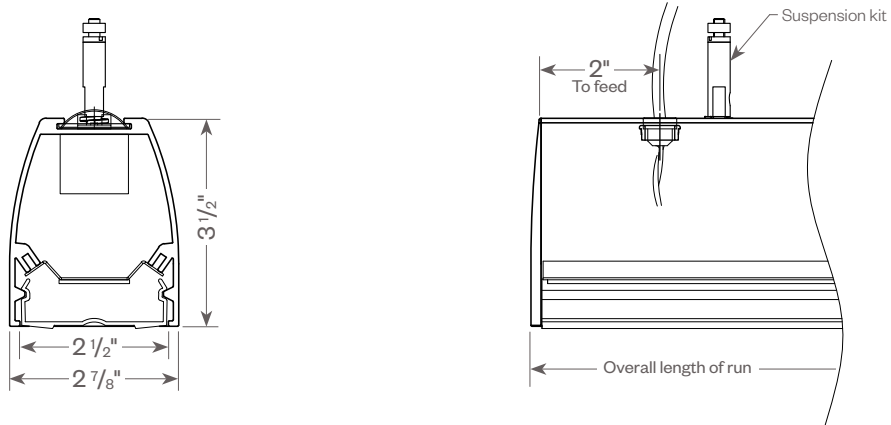

PRODUCER WITH TRACK

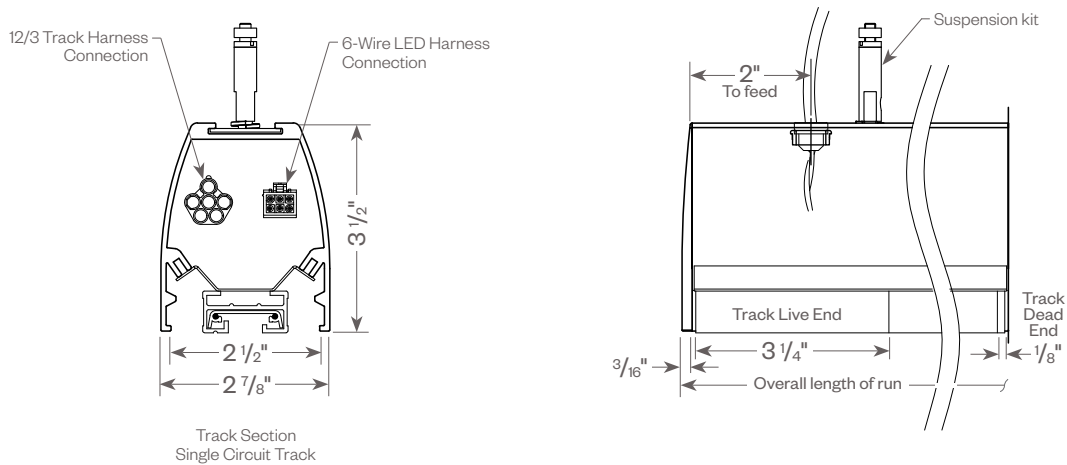

Track Section
Single Circuit Track

SUSPENSION

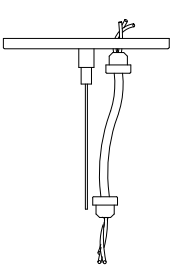

LED Power Feed Canopy
(Circuit A with 2LE Option)
A/C Cable with 18/6 Cord
White Canopy 5" dia.
Length: ASW5 - 5' length
ASW10 - 10' length
ASW20 - 20' length

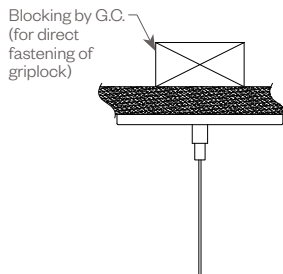

NON-Feed Suspension Point
A/C Cable
White Canopy 5" dia.
Length: ASW5 - 5' length
ASW10 - 10' length
ASW20 - 20' length

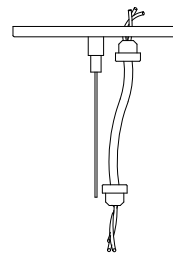

Track Power Feed Canopy
A/C Cable with 12/3 Cord
White Canopy 5" dia.
Length: ASW5 - 5' length
ASW10 - 10' length
ASW20 - 20' length

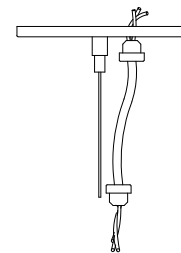

Circuit B Power Feed Canopy
A/C Cable with 18/6 Cord
White Canopy 5" dia.
Length: ASW5 - 5' length
ASW10 - 10' length
ASW20 - 20' length
Note: Each fixture on Circuit B to have its own feed.

Producer Combo

Linear LED with Track



PROJECT:

TYPE:

PRODUCER-TRACK SECTIONS

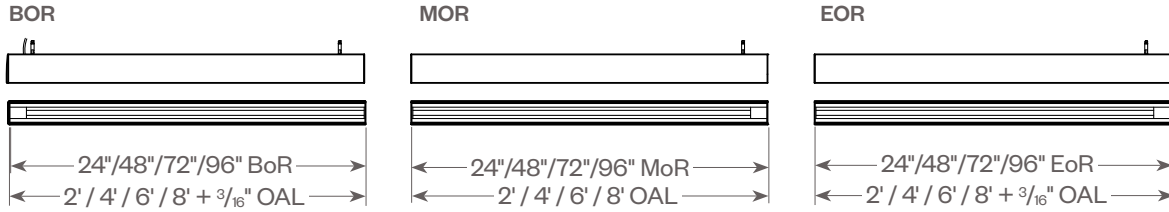

EXAMPLE ROW LAYOUTS (SHOWN WITH 2' TRACK SECTION)

5', 6' or 8' L BOR or L BOR-PF or 2PF

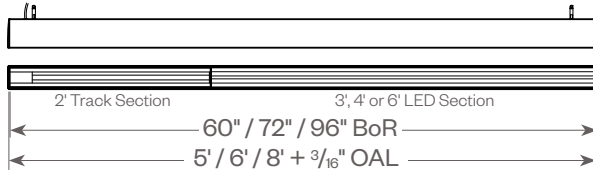

5', 6' or 8' L MOR or L MOR-PF

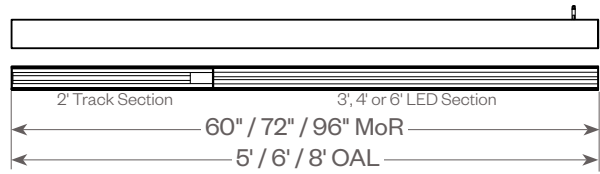

5', 6' or 8' R BOR or R BOR-PF or 2PF

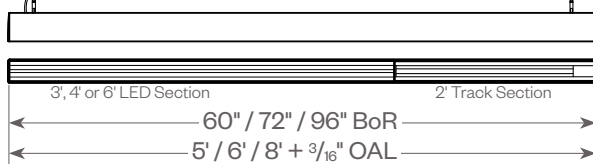

5', 6' or 8' R MOR or R MOR-PF or 2PF

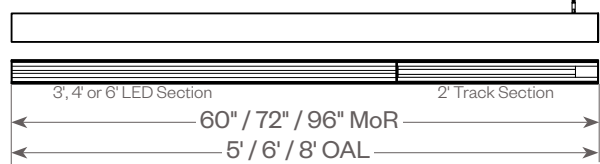

4', 6' or 8' BOR or BOR-PF

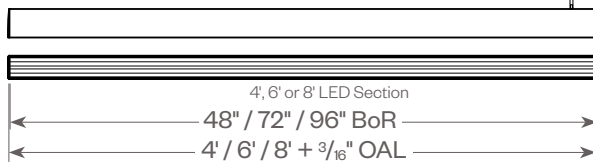

4', 6' or 8' MOR or MOR-PF

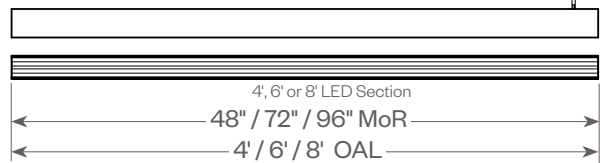

5', 6' or 8' L EOR or L EOR-PF

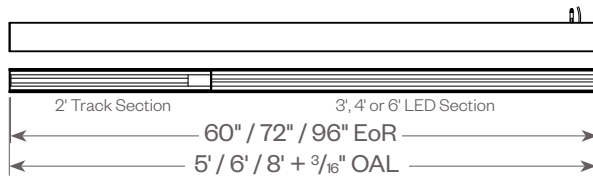

5', 6' or 8' R EOR or R EOR-PF

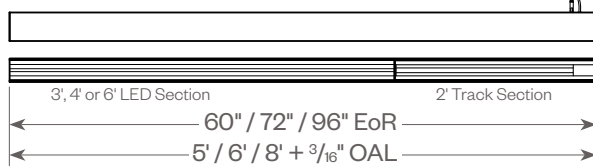

4', 6' or 8' EOR or EOR-PF

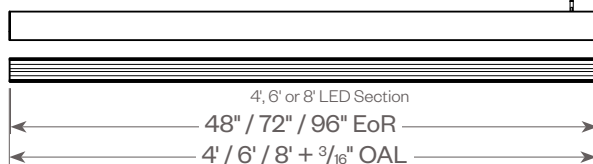

Producer Combo

Linear LED with Track



PROJECT:

TYPE:

FIXTURE DATA: (Complete photometric data (.ies format) available upon request)

MULTIPLYING FACTORS: (Multiplying Factor is based on 3500K-83 120V IES file on website)

Wattage:	3W	4W	5W	6W	7W	8W	9W	10W
Factor:	0.36	0.46	0.56	0.66	0.76	0.85	0.93	1.0

CCT-CRI:	2700K-83	3000K-83	3500K-83	4000K-83	2700K-90+	3000K-90+	3500K-90+	4000K-90+
Factor:	0.91	0.96	1.0	1.01	0.80	0.84	0.88	0.89

PRODUCER DIRECT, BAT60, 10W 3500K 4FT

Total Watts: 38
Total Lumens: 5,016
Source: 128 White LED's

LTL# 13360049.01

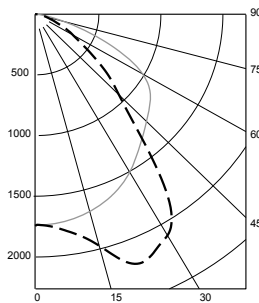

ZONAL LUMEN SUMMARY

Zone	Lumens	%Fixt
0-40	2739	54.6
0-60	4452	88.8
0-90	5016	100.00
90-180	0	0.00

Efficacy = 132.4 Lumens /Watt

COEFFICIENTS OF UTILIZATION

Effective Floor Cavity Reflectance 20%

RC	80			
RW	70	50	30	10
RCR				
0	119	119	119	119
1	110	106	103	99
2	102	94	88	83
3	93	84	77	71
4	86	75	67	61
5	79	68	59	53
6	74	61	53	47
7	68	55	47	41
8	64	51	43	37
9	59	47	39	33
10	56	43	35	30

Note: Values expressed as percent of total output delivered to the task surface.

PRODUCER DIRECT, BAT80, 10W 3500K 4FT

Total Watts: 38
Total Lumens: 4,886
Source: 128 White LED's

LTL# 13360049.02

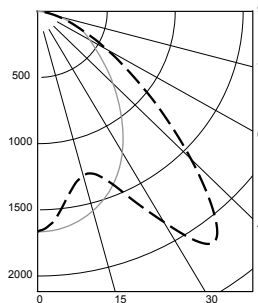

ZONAL LUMEN SUMMARY

Zone	Lumens	%Fixt
0-40	2124	43.5
0-60	4079	83.5
0-90	4886	100.00
90-180	0	0.00

Efficacy = 129.2 Lumens /Watt

COEFFICIENTS OF UTILIZATION

Effective Floor Cavity Reflectance 20%

RC	80			
RW	70	50	30	10
RCR				
0	119	119	119	119
1	109	105	101	97
2	100	92	85	79
3	91	80	72	66
4	83	71	62	56
5	76	63	54	48
6	70	57	48	41
7	65	51	42	36
8	60	46	38	32
9	56	42	34	28
10	52	39	31	26

Note: Values expressed as percent of total output delivered to the task surface.

PRODUCER DIRECT, BAT60, 10W 3500K 4FT W/UPLIGHT

Total Watts: 38
Total Lumens: 5,266
Source: 128 White LED's (Direct) and 24 White LED's (Indirect)

LTL# 13402658.01

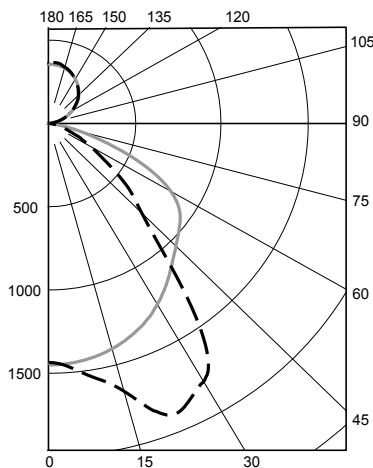

ZONAL LUMEN SUMMARY

Zone	Lumens	%Fixt
0-40	2310	43.9
0-60	3754	71.3
0-90	4222	80.2
90-180	1044	19.8

Efficacy = 141.0 Lumens /Watt

COEFFICIENTS OF UTILIZATION

Effective Floor Cavity Reflectance 20%

RC	80			
RW	70	50	30	10
RCR				
0	114	114	114	114
1	106	102	98	95
2	97	90	84	79
3	89	80	73	67
4	82	71	63	57
5	76	64	56	50
6	70	58	49	44
7	65	52	44	39
8	60	48	40	34
9	56	44	36	31
10	53	40	33	28

Note: Values expressed as percent of total output delivered to the task surface.

Producer Combo

Linear LED with Track



PROJECT:

TYPE:

FIXTURE DATA: (Complete photometric data (.ies format) available upon request)

MULTIPLYING FACTORS: (Multiplying Factor is based on 3500K-83 120V IES file on website)

Wattage:	3W	4W	5W	6W	7W	8W	9W
Factor:	0.63	0.82	1.0	1.17	1.34	1.50	1.64

CCT-CRI:	2700K-83	3000K-83	3500K-83	4000K-83	2700K-90+	3000K-90+	3500K-90+	4000K-90+
Factor:	0.91	0.96	1.0	1.01	0.80	0.84	0.88	0.89

PRODUCER, SYMMETRICAL, 5W 3500K 4FT

Total Watts: 19
Total Lumens: 1,795
Source: 128 White LED's

LTL# 13170267.27

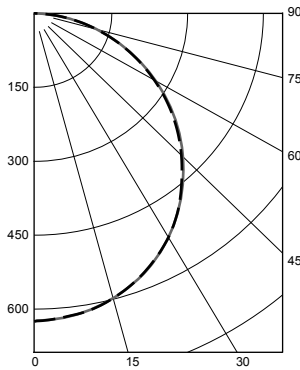

ZONAL LUMEN SUMMARY

Zone	Lumens	%Fixt
0-40	791	44.1
0-60	1395	77.7
0-90	1795	100.0
90-180	0	0.0

Luminaire Efficacy = 92.9 lm/w

COEFFICIENTS OF UTILIZATION

RC	RW			
	70	50	30	10
RCR				
0	119	119	119	119
1	108	104	99	95
2	98	90	83	77
3	90	79	71	64
4	82	70	61	54
5	75	62	53	46
6	70	56	47	41
7	65	51	42	36
8	60	46	38	32
9	56	43	34	29
10	53	39	31	26

Note: Values expressed as percent of total lumen output delivered to the task surface.

PRODUCER, SYMMETRICAL, 10W 3500K 4FT

Total Watts: 39
Total Lumens: 3,358
Source: 128 White LED's

LTL# 13170267.28

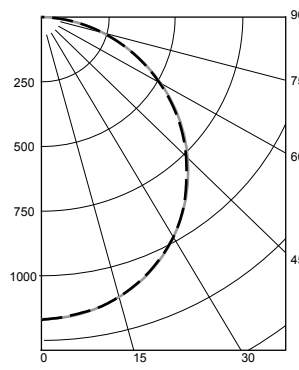

ZONAL LUMEN SUMMARY

Zone	Lumens	%Fixt
0-40	1480	44.1
0-60	2611	77.7
0-90	3358	100.0
90-180	0	0.0

Luminaire Efficacy = 88.7 lm/w

COEFFICIENTS OF UTILIZATION

RC	RW			
	70	50	30	10
RCR				
0	119	119	119	119
1	108	104	99	95
2	98	90	83	77
3	90	79	71	64
4	82	70	61	54
5	75	62	53	46
6	70	56	47	41
7	65	51	42	36
8	60	46	38	32
9	56	43	34	29
10	53	39	31	26

Note: Values expressed as percent of total lumen output delivered to the task surface.

Producer Combo

Linear LED with Track



PROJECT:

TYPE:

DIMMING COMPATIBILITY:

Amerlux® Producer fixtures are compatible with all major dimming protocols prevalent in the United States. Please see below for general compatibilities and wiring diagrams. Amerlux recommends testing your unique dimming configuration as the exact full configuration (Dimmer, Fixture Quantity, Voltage, etc) may affect dimming performance.

--- NOTE: INFORMATION BELOW IS FOR WIRED DIMMERS ONLY. FOR WIRELESS DIMMERS, CONSULT FACTORY ---

0-10V - DIMMING (Standard)

Integrates into a variety of building management and daylighting controls

Notes:

- 120V or 277V*
- Dims down to 1% light output
- Requires interface to turn off power to driver
- Consult Dimming manufacturer for installation instructions - DO NOT SHARE NEUTRALS!

0-10V Wiring Diagram

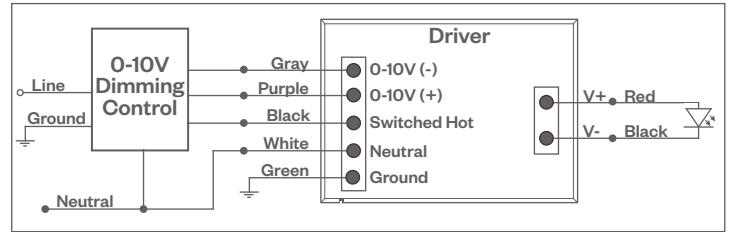

Compatible Dimmers*:

Wall Box

Lutron:
 Diva - DVSTV
 Maestro - MS-Z101
 Nova-T - NTSTV-DV

Wattstopper:
 ADF-120277

Leviton:
 Renoir II

Center System

Lutron Grafikk Eye with GRX-TV1 Interface

LUTRON LDE1 DIMMING

Integrates into Lutron EcoSystem building management

Notes:

- 120VAC or 277VAC*
- Dims down to 1% Soft-On/Fade-to-Black
- EcoSystem Control
- Consult Dimming manufacturer for installation instructions - DO NOT SHARE NEUTRALS!

Lutron LDE1 (HILUME-H-ECO) EcoSystem Digital Control Wiring Diagram

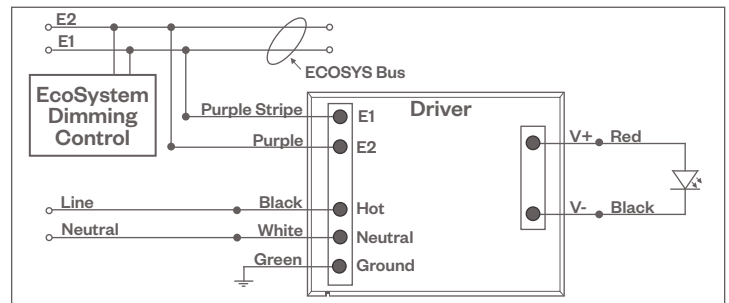

Compatible Dimmers*:

Lutron ECO System

Pow Pak Dimming Modules
 Energi Savr Node
 Grafik Eye QS/Homeworks
 QS Control Unit
 Quantum Hub
 Homeworks QS/My Room

Central System

Lutron EcoSystem compatible controls

DALI - DALI DIMMING 120V-277V

Digital control protocol allows individual fixture control

Notes:

- 120VAC - 277VAC*
- Dims down to 1% light output in most cases

DALI Wiring Diagram

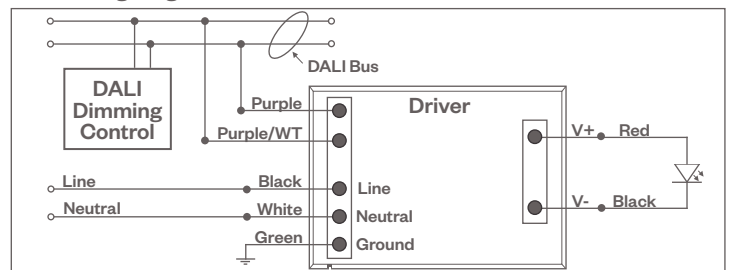

Compatible Dimmers*:

Wall Box

Leviton CD250 Controller

Center System

Dynalite
 Fifth Light

Notes:

* Driver is 277VAC dimmable with appropriate dimmer (by others). All provided wiring diagrams show 120VAC wiring colors and method. Please refer to 277VAC dimmer installation instructions for 277VAC wiring diagrams.

† The absence of a dimmer from the lists above does not imply incompatibility. Please consult factory for compatibility inquiries.