

# CURVANO® 2.5"

## Curved Recessed Linear LED

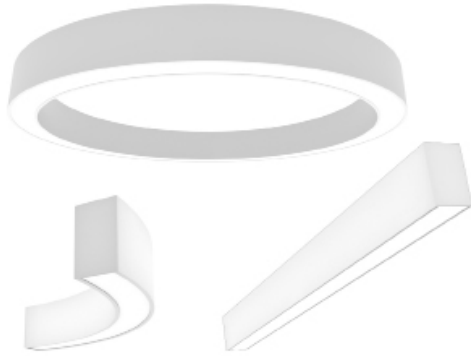

### Features

Curvano expands on the existing linear slot portfolio of Amerlux, further putting the “arch” in first-class architectural lighting. The 2.5" profile is available in 5 diameter options, as either a curved corner or full 360° circle. With the ability to fit in seamlessly anywhere on your project, from the simplest design to the most complex, Curvano provides infinite design and lighting patterns options: circular, serpentine and rounded-circle displays included. Trust Curvano to provide the freedom to create—and maintain—dynamic, head-turning spaces.

### Product Overview

Type:	Recessed
Wattage:	3W-10W/ft
Max Lumen Output:	3059 lm, 77.6 lm/W (10W, 4')
Color Temp:	2700K, 3000K, 3500K, 4000K
CRI:	83 or 90+ typ.
Dimming:	0-10V, 1% dimming (standard) Lutron Hi-lume® 2 wire (120V only) Lutron Hi-lume® EcoSystem, 1% dim, fade to off DALI dimming, 0.1% dim

### PROJECT:

### TYPE:

### Fixture Summary *(see following pages for more information)*

#### Performance Chart

Watts Per Foot	Delivered Lumens	Lumens Per Foot	Lumens Per Watt
5	1672	418	84.6
10	3059	765	77.6

*Lumen Output based on 4', 3500K-80 fixture.*

#### Electrical Data

Wattage Per Foot	Volts	System Watts	Amps
5	120V	20	0.16
	277V	20.8	0.08
10	120V	39.7	0.33
	277V	39.7	0.15

*4' fixture, electronic multi-volt (120V-277V), constant current LED driver*



# CURVANO® 2.5

Curved Recessed Linear LED



**PROJECT:**

**TYPE:**

**Ordering Information**

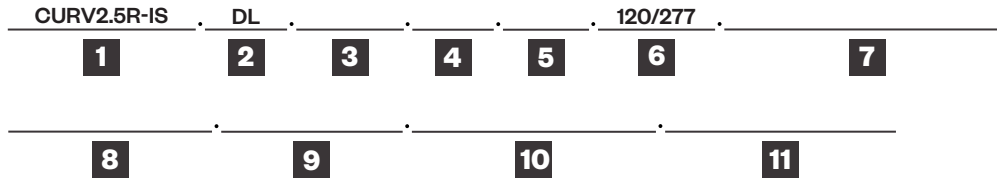

**1 Model**  
**CURV2.5R-IS** (independently suspended)

**2 Optic**  
**DL** - designer lens

**3 Wattage** (per foot)  
**3** - 3W/ft (4' minimum length required)  
**4** - 4W/ft (4' minimum length required)  
**5** - 5W/ft  
**6** - 6W/ft  
**7** - 7W/ft  
**8** - 8W/ft  
**9** - 9W/ft  
**10** - 10W/ft

**4 Color Temp-CRI**  
**30** - 3000K-83      **279** - 2700K-90+  
**35** - 3500K-83      **309** - 3000K-90+  
**40** - 4000K-83      **359** - 3500K-90+  
                                 **409** - 4000K-90+

Consult factory for 90CRI lead time

**5 Finish**  
**HW** - high reflectance matte white  
**BT** - black texture  
**ST** - silver texture

**6 Voltage**  
**120/277**

**7 Length**

(Length A)	(Length B)	(Length C)
- all patterns	- all patterns - PU	
- IND	- PZ	
- CON		
- CUS		

For CIR and ARC configurations, skip to "Diameter & Angle"

**8 Diameter & Angle**  
**D22** - 22" diameter      **A45** - 45° angle  
**D36** - 36" diameter      **A90** - 90° angle  
**D43** - 43" diameter      **A135** - 135° angle  
**D72** - 72" diameter      **A180** - 180° angle  
**D100** - 100" diameter      **CA\_\_\_** - custom angle  
**CD\_\_\_** - custom diameter

(diameter)	(angle)
- ARC	- ARC
- CIR	- PLL/PLR
- PLL/PLR- PU	
- PU	- PZ
- PR	
- PZ	

See page 3 for more detail and restrictions. Patterns with multiple corners to have the same diameter and angle throughout. For IND/CON/CUS skip to "Configuration."  
**For jobs with architectural drawings, original CAD file (.DWG) is required to quote.**

**9 Configuration**  
**IND** - individual straight fixtures, 2' to 8' (in 1' increments)  
**CON** - continuous run, > than 8', specify to nearest foot  
**CUS** - custom made to measure, +/- 1/8" of customer supplied field dimensions  
**ARC** - individual curved fixtures, see diameter and angle options above  
**CIR** - circle (D22, D36, D43 ships assembled; D72, D100 ships in 45° sections)  
**Standard Patterns** (see page 3 for details)  
**PLL** - L left, (2) straight + (1) corner, leg right  
**PLR** - L left, (2) straight + (1) corner, leg left  
**PU** - U shape, (3) straight lengths + (2) corners  
**PR** - Rectangle, (4) straight lengths + (4) corners  
**PZ** - Z shape, (3) straight lengths + (2) corners

For custom patterns, submit EDR on amerlux.com  
**Minimum 10 pieces required for any custom diameter or angle.**

**10 Drivers**  
**0-10V** - 1% electronic dimming, multi-volt (120V-277V) constant current driver (standard).  
**DALI** - DALI Dimming 120V-277V, 0.1% dim  
**HILUME-A-LTE** - Lutron "A" Series, 1% dim, 2-wire, 120V only  
**HILUME-H-ECO** - Lutron "H" Series, 1% dim, fade to off, EcoSystem

**11 Options**  
**ENLS** - Enlighted Sensor (0-10V driver only and not available on 2' and 3' lengths)  
**EMC-PF** - emergency circuit requires power feed located in last fixture section (for other locations consult factory)  
**PF** - extra power feed for additional circuiting  
**WHIP** - 6' whip, 18/5 conductor  
**EMB** - emergency battery pack (4+ straight fixtures only)  
**CP** - Chicago Plenum (CCEA)

# CURVANO® 2.5

Curved Recessed Linear LED



## PROJECT:

## TYPE:

### Diameter and Angle Options

Arc length is the center line length if the curve was straightened out.

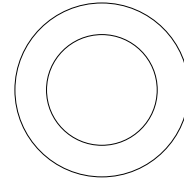
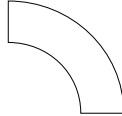

45°	
Diameter	Arc Length
D43	16.89"
D72	28.08"
D100	39.27"

90°	
Diameter	Arc Length
D22	16.89"
D36	28.18"
D43	33.77"

360°	
Diameter	Arc Length
D22	67.54"
D36	112.72"
D43	135.09"
D72*	224.62"
D100*	314.16"

\* shipped as separate 45° fixtures

### Standard Patterns

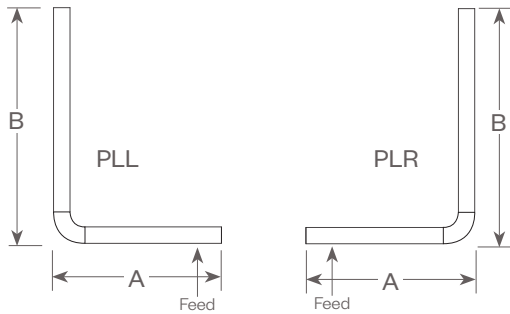

**PLL** - L Left, (2) straights + (1) corner, leg right  
**PLR** - L Right, (2) straights + (1) corner, leg left  
 Provide overall lengths: A' & B'; Diameter & Angle of corner  
**Example: 4'x8'.D43xA90.PLL**

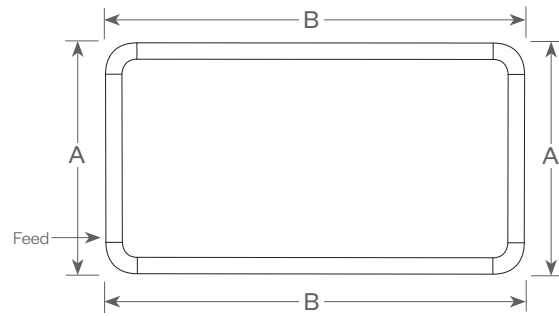

**PR** - Closed Rectangle, (4) straight lengths + (4) 90° corners  
 Provide overall lengths: A' & B'; Diameter  
**Example: 12'x10'.D22.PR**

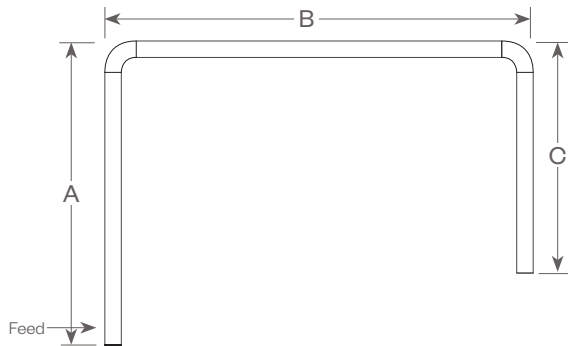

**PU** - Open U, (3) straight lengths + (2) corners  
 Provide overall lengths: A', B' & C'; Diameter & Angle of corners  
**Example: 4'x10'.D72xA45.PU**

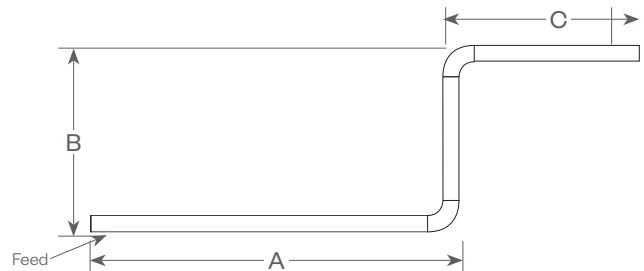

**PZ** - Open Z, (3) straight lengths + (2) corners  
 Provide overall lengths: A', B' & C'; Diameter & Angle of corners  
**Example: 12'x6'x10'.D36XA90.PZ**

# CURVANO® 2.5

Curved Recessed Linear LED



## PROJECT:

## TYPE:

### Specifications

#### Application

Retail and commercial ambient lighting that can be customized with a variety of diameters and angles to create any curved pattern or variety of illuminated circles.

#### Construction

Extruded aluminum housing. Die-cast End Plates match fixture body finish. Die-formed, cold-rolled steel internal components are protected against rust and corrosion.

#### Optical

Laser cut acrylic lens, with lift and shift lay-in design. Maximum length is 8' and maximum angle is 90° (ex. 180° curve will have 2 lenses; Circle will have 4 lenses). All lenses ship installed into fixture. Amerlux's proprietary acrylic lens provide excellent transmission while effectively concealing source image.

**DL** – Designer Lens provides flat even glow on lens

#### LED

Amerlux fixtures have excellent thermal management and offer a 5 year warranty. Our LED binning is within 3 MacAdam ellipse. Boards are configured for maximum flexibility resulting in even illumination no matter the fixture layout. LED boards are easily replaced in the field with just a Phillips screw driver.

**Color Temperature Options:** 2700K, 3000K, 3500K, 4000K

**CRI:** 83 or 90+ typical

**R9:** 16 @ CRI 83; >50 @ CRI 90+

**Life:** 50,000+ hr., > 70% of initial lumens (L70)

#### Electrical

**Wiring:** Supply wires are easily accessible through access plate on top of fixture.

**Remote Driver Wiring (D22, D36 & D43 ARC or CIR only):** Driver is supplied installed in remote driver box, (one driver per box), with 5' of low voltage plenum rated cable. Fixture supplied with 18/2 SJT power cord ready to be connected to J-Box (by others). Amerlux recommends a maximum of 15' between the fixture and the remote driver box. Consult factory with job specific electrical spec if more than 15' is required. Feeds are added as required by specified wattage and driver maximums. See page 5 for wiring illustration.

**WHIP:** Optional factory installed 6' Greenfield whip (18/5 conductor) simplifies installation

**Standard Wattage:** 3-10 W/ft (3W & 4W have a minimum length of 4'). Emergency circuit via remote invert or auxiliary emergency power supply (by others)

**This product complies with IEEE C62.41 for surge endurance up to 2.5KV. Amerlux® recommends using additional surge protection with this unit (supplied by others), surge and over voltage damage is not covered under warranty.**

**ENLS** - Enlighted Sensor (0-10V driver only, not available in 2' & 3' lengths, and can only be used on one circuit). Limited to straight fixtures only.

**EMC-PF** - Emergency circuit requires power feed to be located in last fixture section for continuous runs. For other locations consult factory. Not available for individual (IND) configuration.

**PF** - Extra power feed for additional circuiting. Not available for individual (IND) configuration.

**EMB** - Emergency battery pack - Bodine BSL10LST self-testing driver, 10W output power, 90 min of illumination time. Illuminated test-switch/charging indicator light is provided. Wattage consumption by EM: 2.5W/ft (4ft fixture), 1.66W/ft (6ft fixture), 1.25W/ft (8ft fixture). Request can be made to light up 4ft section on 8ft unit.

#### Drivers

**0-10V** - 1% electronic dimming, multi-volt (120V-277V) constant current driver (standard). Cap leads for non-dim applications.

**HILUME-A-LTE** - Lutron "A" Series, 1% dim, 2-wire, 120V only

**HILUME-H-ECO** - Lutron "H" Series, 1% dim, fade to off, EcoSystem

**DALI** - DALI Dimming 120-277VAC, 1% dim

For wiring diagrams & more information see pgs 8-9

#### Finish

All painted surfaces are premium powder coated baked on for maximum durability and color stability.

**HW** - High reflective matte White

**BT** - Black Texture

**ST** - Silver Texture

For special paint colors supply RAL and/or actual paint chip for factory consultation.

#### Configurations/Lengths

**IND** - Individual straights are standalone fixtures made of single lengths of 2' to 8' (in 1' increments). They are supplied with matching painted End Caps and the required mounting hardware. Lengths less than 4' may have restrictions based upon wattage, lengths, drivers or other options.

**CON** - Continuous runs are longer than 8', specified to the nearest whole foot. Continuous runs less than 16' are made of 2 lengths. Continuous runs longer than 16' start with a 8' Beginning of Row (BoR) wired with a power feed and fitted with an End Cap. The majority of the runs are made up of 8' Middle of Run (MoR) lengths. End of Run (EoR) units are made up of 2' to 8' units to the nearest whole foot or a combination of a last 4' MoR and a 5', 6' or 7' EoR. Runs longer than 60' may require a second power feed. Factory installed pins and splines simplify fixture alignment. Lengths are quickly joined with "catch and latch" mechanisms or screws and sturdy brackets. Quick connectors simplify field wiring.

**CUS** - Custom made to measure runs are made to nearest 1/8" of customer supplied field measurements. They can be a single custom length or runs configured as described above only EoR's are 2' to 8' cut to the nearest 1/8" exact length or a combination of a last 4' MoR with an EoR cut to exact length to the nearest 1/8".

**ARC** - Individual arcs are standalone fixtures made of single lengths using a diameter and an angle (ex. D43 x A90 is a 4' diameter, 90° individual fixture). They are supplied with matching painted End Caps and the required mounting hardware. D22, D36 & D43 utilize a remote mounted driver.

**CIR** - Circle fixtures made up of a single housing (D22, D36 & D43) or shipped in 45° segments (D72, D100). D22, D36 & D43 utilize a remote mounted driver.

**PLL/PLR/PR/PU/PZ** - Standard patterns consist of standard diameter & angle corners with standard lengths (3' to 8' in 1' increments) or custom lengths. Patterns with multiple corners will have the same diameter and angle utilized throughout the pattern. Depending upon complexity of the pattern, drawings may be required. When ordering please give overall lengths. See page 3 for layouts.

**PC** - Custom patterns use standard or custom lengths, 90° or other corner angles with some limitations. Please provide drawings and consult factory

#### Mounting

Intended for use in millwork ceilings. For individual, continuous row, or pattern applications

Please note - fixtures to be installed before ceiling.

**CURV2.5R-IS** - Independently suspended, fixture in wood ceiling

#### Certifications

Approved to UL standards as tested by CSA. Intended for indoor use only Chicago Plenum (CCEA) option

#### Warranty

Amerlux's 5 year limited warranty. Please consult Amerlux website for details.

# CURVANO® 2.5

Curved Recessed Linear LED



## PROJECT:

## TYPE:

### CROSS SECTION

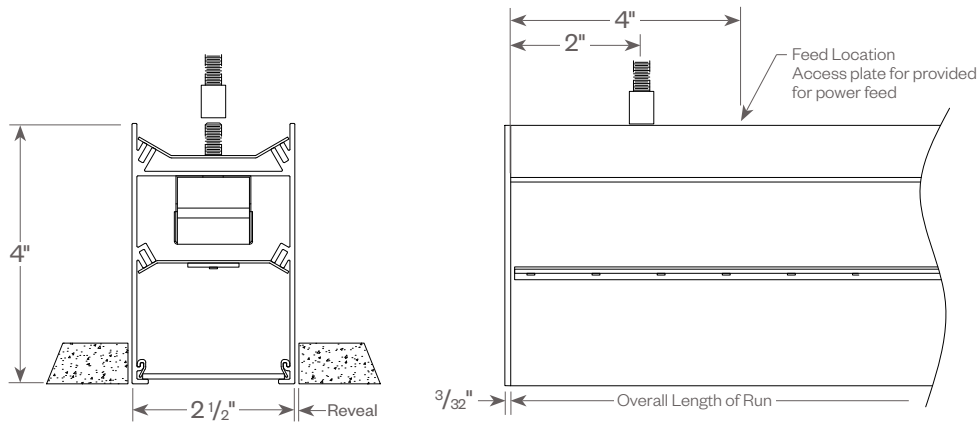

### LENS INSTALL/REMOVAL

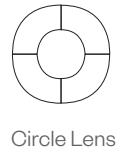
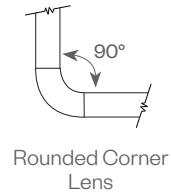
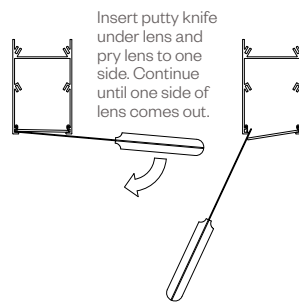
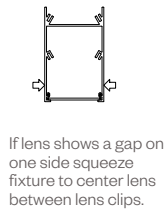
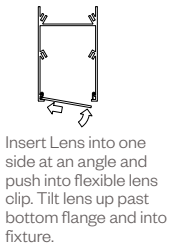

### TOOLLESS JOINING

Line up the two housings by using the alignment pins & splines. Secure them together by using the Catch & Latch System on the top of or inside the extrusion.

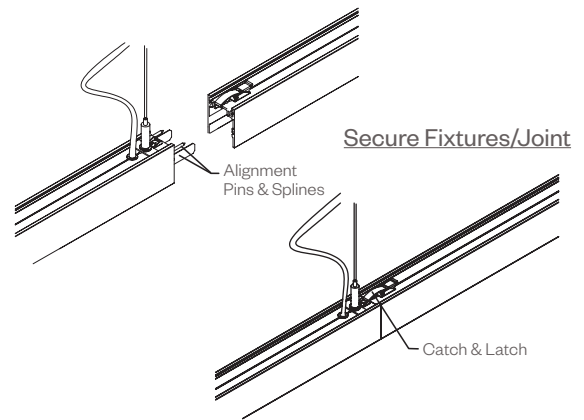

### REMOTE DRIVER

D22/36/43 ARC & CIR configurations only  
 Note: Driver required for every 4'. Remote drivers can be installed up to 15' max from fixture.

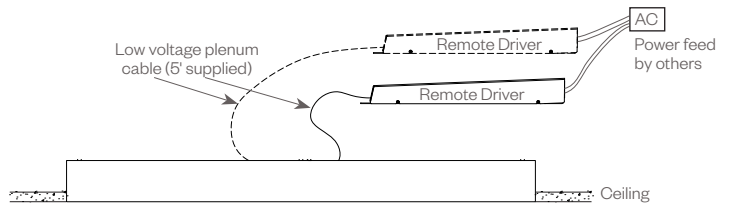
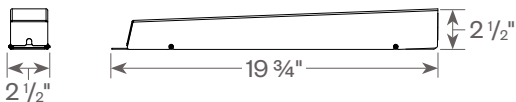

# CURVANO® 2.5

Curved Recessed Linear LED



**PROJECT:**

**TYPE:**

**RUN LENGTHS AND DIMENSIONS** (View from top of fixture. Black dots represent mounting points)

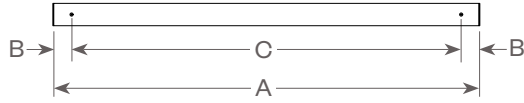

IND			
Length	A	B	C
2'	24"	2-3/32"	19-7/8"
3'	35-7/8"	2-3/32"	31-3/4"
4'	47-3/4"	2-3/32"	43-9/16"
5'	59-11/16"	2-3/32"	55-1/2"
6'	71-9/16"	2-3/32"	67-3/8"
7'	83-7/16"	2-3/32"	79-1/4"
8'	95-5/16"	2-3/32"	91-1/8"

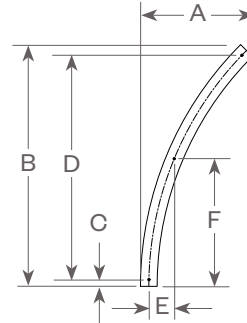

45° ARC						
Diameter	A	B	C	D	E	F
D43	8-7/16"	16-1/16"	1"	14-1/2"	1-5/8"	8-1/4"
D72	12-5/8"	26-3/16"	1"	24-9/16"	2-3/4"	13-11/16"
D100	16-3/4"	36-1/4"	1"	34-5/8"	3-13/16"	19-1/8"

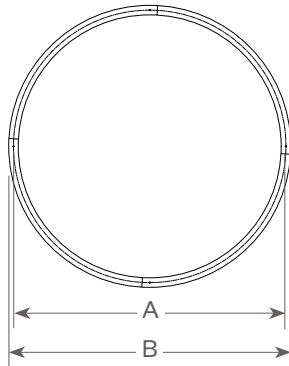

CIR		
Diameter	A	B
D22	21-5/8"	24-1/8"
D36	35-7/8"	38-3/8"
D43	43"	45-1/2"
D72	71-1/2"	74"
D100	100"	102-1/2"

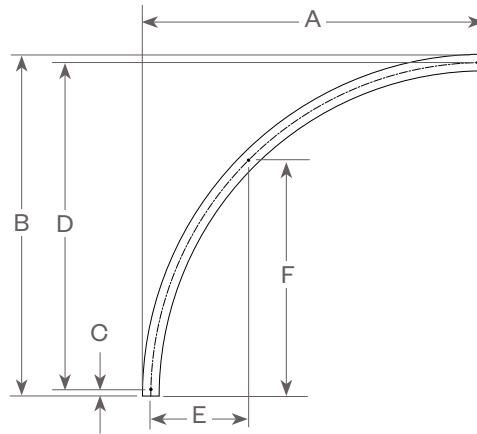

90° ARC						
Diameter	A	B	C	D	E	F
D22	12-1/16"	12-1/16"	1"	10-3/4"	3-3/16"	7-5/8"
D36	19-3/16"	19-3/16"	1"	17-15/16"	5-1/4"	12-11/16"
D43	22-3/4"	22-3/4"	1"	21-1/2"	6-5/16"	15-3/16"

# CURVANO® 2.5

Curved Recessed Linear LED



## PROJECT:

## TYPE:

**FIXTURE DATA:** (Complete photometric data (.ies format) available upon request)

**MULTIPLYING FACTORS:** (Multiplying Factor is based on 3500K-83 120V IES file on website)

Wattage:	3W	4W	5W	6W	7W	8W	9W	10W
Factor:	0.67	0.83	<b>1.0</b>	1.17	1.33	1.5	1.66	1.83

Wattage:	3W	4W	5W	6W	7W	8W	9W	10W
Factor:	0.37	0.46	0.55	0.64	0.73	0.82	0.91	<b>1.0</b>

CCT:	3000K-83	3500K-83	4000K-83
Factor:	0.97	1.0	1.01

CCT:	2700K-90+	3000K-90+	3500K-90+	4000K-90+
Factor:	0.90	0.93	0.96	0.97

### CURV2.5R DL 5W 3500K 4FT

Total Watts: 20  
Total Lumens: 1672  
Source: 112 direct White LEDs

LTL# 13450111.01

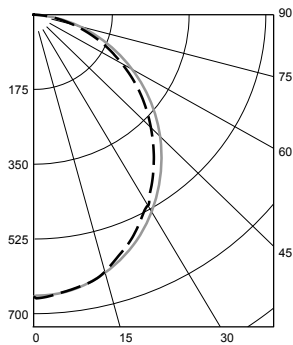

#### ZONAL LUMEN SUMMARY

Zone	Lumens	%Fixt
0-40	790	47.3
0-60	1345	80.5
0-90	1672	100.0
90-180	0	0.0

Efficacy = 84.6 Lumens /Watt

#### COEFFICIENTS OF UTILIZATION

Effective Floor Cavity Reflectance 20%

RC	80			
	70	50	30	10
ROR				
0	119	119	119	119
1	109	104	100	96
2	99	91	85	79
3	91	80	72	66
4	83	71	63	56
5	77	64	55	49
6	71	58	49	43
7	66	52	44	38
8	61	48	40	34
9	57	44	36	31
10	54	41	33	28

Values are expressed as percent of total lumen output delivered to the task surface.

### CURV2.5R DL 10W 3500K 4FT

Total Watts: 39  
Total Lumens: 3059  
Source: 112 direct White LEDs

LTL# 13450111.04

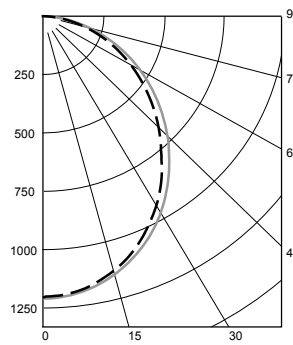

#### ZONAL LUMEN SUMMARY

Zone	Lumens	%Fixt
0-40	1449	47.4
0-60	2452	80.2
0-90	3059	100.0
90-180	0	0.0

Efficacy = 77.6 Lumens /Watt

#### COEFFICIENTS OF UTILIZATION

Effective Floor Cavity Reflectance 20%

RC	80			
	70	50	30	10
ROR				
0	119	119	119	119
1	109	104	100	96
2	99	91	84	79
3	91	80	72	66
4	83	71	63	56
5	77	64	55	49
6	71	58	49	43
7	66	52	44	38
8	61	48	40	34
9	57	44	36	31
10	54	41	33	28

Values are expressed as percent of total lumen output delivered to the task surface.

# CURVANO® 2.5

Curved Recessed Linear LED



## PROJECT:

## TYPE:

### DIMMING COMPATIBILITY:

Amerlux® Curvano® fixtures are compatible with all major dimming protocols prevalent in the United States. Please see below for general compatibilities and wiring diagrams. Amerlux recommends testing your unique dimming configuration as the exact full configuration (Dimmer, Fixture Quantity, Voltage, etc) may affect dimming performance.

**--- NOTE: INFORMATION BELOW IS FOR WIRED DIMMERS ONLY. FOR WIRELESS DIMMERS, CONSULT FACTORY ---**

### 0-10V - DIMMING (Standard)

Integrates into a variety of building management and daylighting controls

#### Notes:

- 120V or 277V\*
- Dims down to 1% light output
- Requires interface to turn off power to driver
- Consult Dimming manufacturer for installation instructions - DO NOT SHARE NEUTRALS!

#### Compatible Dimmers†:

##### Wall Box

Lutron:	Wattstopper:	Leviton:
Diva - DVSTV	ADF-120277	Renoir II
Maestro - MS-Z101		
Nova-T - NTSTV-DV		

##### Center System

Lutron Grafikx Eye with GRX-TV1 Interface

#### 0-10V Wiring Diagram

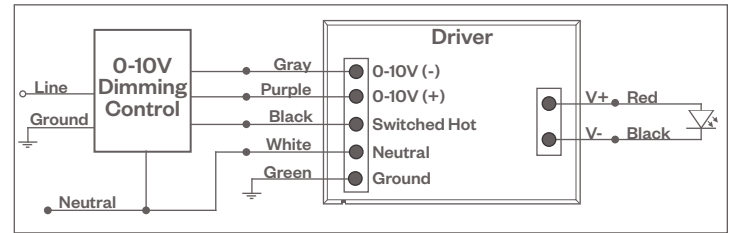

### LUTRON HI-LUME DIMMING

Integrates into Lutron EcoSystem building management

#### Notes:

- 120V or 277V\*
- Dims down to less than 5% light output
- EcoSystem Control
- Consult Dimming manufacturer for installation instructions - DO NOT SHARE NEUTRALS!

#### Compatible Dimmers†:

##### Wall Box

##### Lutron:

Diva  
Maestro  
Nova-T  
Vareo

### HILUME-H-ECO

#### EcoSystem Digital Control Wiring Diagram

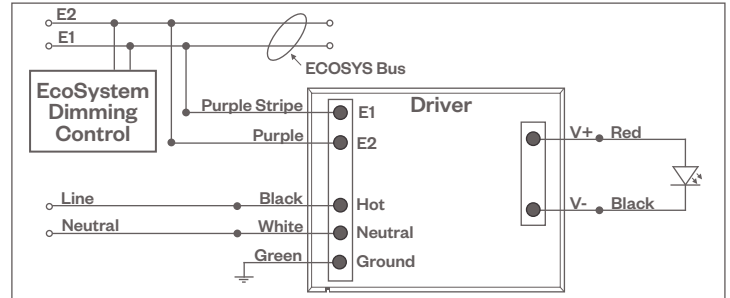

##### Center System

Lutron EcoSystem compatible controls

#### Notes:

- \* Driver is 277V dimmable with appropriate dimmer (by others). All provided wiring diagrams show 120V wiring colors and method. Please refer to 277V dimmer installation instructions for 277V wiring diagrams.
- † The absence of a dimmer from the lists above does not imply incompatibility. Please consult factory for compatibility inquiries.



# CURVANO® 2.5

Curved Recessed Linear LED



## PROJECT:

## TYPE:

### DIMMING COMPATIBILITY:

Amerlux® Curvano® fixtures are compatible with all major dimming protocols prevalent in the United States. Please see below for general compatibilities and wiring diagrams. Amerlux recommends testing your unique dimming configuration as the exact full configuration (Dimmer, Fixture Quantity, Voltage, etc) may affect dimming performance.

**--- NOTE: INFORMATION BELOW IS FOR WIRED DIMMERS ONLY. FOR WIRELESS DIMMERS, CONSULT FACTORY ---**

### LUTRON HILUME-A-LTE DIMMING

Utilizes "Standard" incandescent dimmers that are in wide use in installations across the US. Best for retrofit applications where TRIAC dimmers are installed.

#### Notes:

- 120V only
- Dims down to less than 1% light output (most cases)
- Consult Dimming manufacturer for installation instructions - DO NOT SHARE NEUTRALS!
- Must meet dimmer Minimum Load Requirements per dimming manufacturer

#### Compatible Dimmers\*:

**Wall Box** (Incandescent Style, Wattage as required)

#### Lutron:

Diva  
Maestro  
Nova-T  
Vareo  
Skylark

Lutron HILUME-A-LTE Wiring Diagram

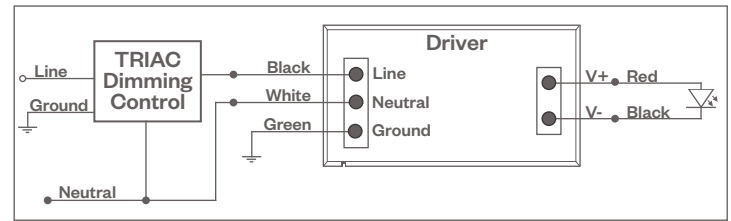

#### Center System

Lutron "GP" Panel  
Lutron Grafik Eye QS

### DALI - DALI DIMMING 120V-277V

Digital control protocol allows individual fixture control

#### Notes:

- 120V - 277V\*
- Dims down to 0.1% light output in most cases

#### Compatible Dimmers\*:

#### Wall Box

Leviton CD250 Controller

#### Center System

Dynalite  
Fifth Light

DALI Wiring Diagram

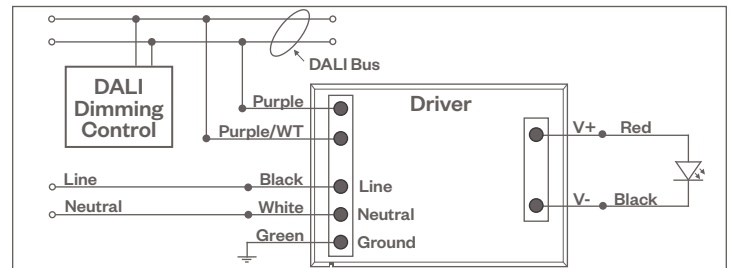

#### Notes:

- \* Driver is 277V dimmable with appropriate dimmer (by others). All provided wiring diagrams show 120V wiring colors and method. Please refer to 277V dimmer installation instructions for 277V wiring diagrams.
- † The absence of a dimmer from the lists above does not imply incompatibility. Please consult factory for compatibility inquiries.