

Carisma 2"

Linear Direct



PROJECT:

TYPE:

Features

Carisma Pendant is part of a family of architectural linear luminaires that offer excellent performance, quality, visuals and value. A sleek edge-to-edge lens design results in an elegant aesthetic with clean lines. Carisma's patent pending design includes an integrated optical system that minimizes optical losses, allowing for industry-leading efficacy that meets the stringent requirements for DLC Listing (*DLC Listing pending*). A tailored end cap design and Amerlux's trusted catch-and-latch mechanism prevents all light leakage.

The Carisma Pendant offers luminaires with 2" and 3" wide apertures, delivering seamless lighting as discrete individual fixtures, continuous rows or patterns. Carisma can be specified to the nearest 1/8" and is available in pendant, surface, wall and recessed mounting options, providing designers with the versatility to light up a space with their Carisma.

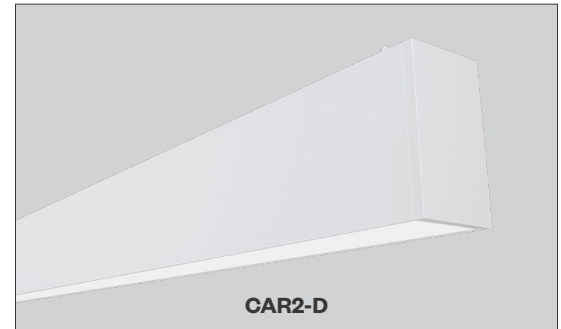

Product Overview

Type: Direct distribution with Pendant, Surface or Wall Mounting
 Wattage: 5W/ft, 10W/ft (or specify wattage between 3W/ft and 10W/ft)
 Color Temp: 2700K*, 3000K, 3500K, 4000K (*90+ CRI only)
 CRI: 80+ typ. or 90+ typ.
 Dimming (wired): 0-10V, 1% dim, 120/277VAC (standard)
 Lutron LDE1 Hi-lume® 1% Soft-On/Fade-to-Black
 DALI, 1% dim
 Dimming (wireless): Enlighted Sensor
 Lutron Athena (integral wireless RF node)

Certifications



Fixture Summary

Performance Data

Wattage per Foot	Lens	Delivered Lumens	LPW
5	PL	2519	126.8
10	PL	4755	122.8
5	ASY	2693	135.6
10	ASY	5408	128.6

Data is based on 4' fixture, 3500K-80 120V IES files available on website.

Runs

Individual Runs: 2' - 8' (specify in 1' increments).
 Continuous Runs: > 8' (specify to the nearest foot).
 Custom: Made to measure lengths available (specify to nearest 1/8" of field dimensions). Requires approval drawings. Added cost & lead time.

Electrical Data

Wattage per Foot	Voltage	4'		8'	
		System Watts	Amps	System Watts	Amps
5	120V	19.8	0.17	40.2	0.34
	277V	20.5	0.07	40.1	0.15
10	120V	38.7	0.32	80.3	0.67
	277V	40	0.15	79	0.29

Electronic multi-volt (120-277VAC), constant current LED driver.

Standard Patterns

					Wall to Ceiling	Custom
Yes	Yes	Yes	Yes	Yes	No	No

Carisma 2"

Linear Direct



PROJECT:

TYPE:

Ordering Information

CAR2-D			120/277							
1	2	3	4	5	6	7	8	9	10	11

1	Model	2	Optics	3	Mounting
	CAR2-D		<p>PL performance lens</p> <p>ASY asymmetric lens</p>		<p><u>Pendant Mount</u> (<i>aircraft cable suspension</i>)</p> <p>ASW04 through ceiling tile or gyp board, white, 4'*</p> <p>ASW10 through ceiling tile or gyp board, white, 10'</p> <p>ASW20 through ceiling tile or gyp board, white, 20'</p> <p>ASB04 through ceiling tile or gyp board, black, 4'*</p> <p>ASB10 through ceiling tile or gyp board, black, 10'</p> <p>ASB20 through ceiling tile or gyp board, black, 20'</p> <p>ASW04T over ceiling tee, white, 4'*</p> <p>ASW10T over ceiling tee, white, 10'</p> <p>ASW20T over ceiling tee, white, 20'</p> <p>ASB04T over ceiling tee, black, 4'*</p> <p>ASB10T over ceiling tee, black, 10'</p> <p>ASB20T over ceiling tee, black, 20'</p> <p><i>* 4' (xxx04) is standard length, other lengths are additional charge</i></p>
					<p><u>Wall Mount</u></p> <p>WM wall mount</p> <p><u>Surface Mount</u></p> <p>SM surface mount</p>

4	Wattage (per foot)	5	Color Temp	6	Finish	7	Voltage
	<p>Standard Optional</p> <p>5 5W/ft 3* 3W/ft</p> <p>10 10W/ft 4* 4W/ft</p> <p> 6 6W/ft</p> <p> 7 7W/ft</p> <p> 8 8W/ft</p> <p> 9 9W/ft</p> <p><i>* 3' min. length required</i></p>		<p>80+ CRI 90+ CRI</p> <p>30 3000K-80+ 279 2700K-90+</p> <p>35 3500K-80+ 309 3000K-90+</p> <p>40 4000K-80+ 359 3500K-90+</p> <p> 409 4000K-90+</p>		<p>HW high reflectance matte white</p> <p>BT black texture</p> <p>ST silver texture</p> <p><i>For other RAL color, consult factory</i></p>		120/277

8	Length	9	Configuration																	
	<table border="1"> <tr> <td>X</td> <td>X</td> <td>X</td> </tr> <tr> <td>Length A</td> <td>Length B</td> <td>Length C</td> </tr> <tr> <td>- all patterns</td> <td>- all patterns</td> <td>- PU</td> </tr> <tr> <td>- IND</td> <td>- PR (2 lengths of 2)</td> <td>- PZ</td> </tr> <tr> <td>- CON</td> <td></td> <td></td> </tr> <tr> <td>- CUS</td> <td></td> <td></td> </tr> </table>	X	X	X	Length A	Length B	Length C	- all patterns	- all patterns	- PU	- IND	- PR (2 lengths of 2)	- PZ	- CON			- CUS			<p>IND¹ individual fixture, 2' to 8' in 1' increments</p> <p>CON continuous run > than 8', specify to nearest foot</p> <p>CUS custom made to measure lengths (<i>specify to nearest 1/8" of field dimensions</i>)</p> <p><u>Standard Patterns</u> (<i>see pg 6 for details</i>)</p> <p>PLL L left, (2) straights + (1) 90° corner, leg right</p> <p>PLR L right, (2) straights + (1) 90° corner, leg left</p> <p>PU U shape, (3) straight lengths + (2) 90° corners</p> <p>PR Rectangle shape, (4) straight lengths + (4) 90° corners</p> <p>PZ Z shape, (3) straight lengths + (2) 90° corners</p>
X	X	X																		
Length A	Length B	Length C																		
- all patterns	- all patterns	- PU																		
- IND	- PR (2 lengths of 2)	- PZ																		
- CON																				
- CUS																				

10	Drivers/Controls	11	Options/Accessories
	<p><u>Wired</u></p> <p>0-10V 1% electronic dimming, multi-volt 120-277VAC constant current driver (<i>standard</i>).</p> <p>HILUME-H-ECO Lutron LDE1 Hi-lume® 1% dim Soft-On/Fade-to-Black</p> <p>DALI DALI dimming 120-277VAC, 1% dim</p> <p><u>Wireless</u></p> <p>ENLS-SR Enlighted sensor, energy metering (<i>not available on 2' & 3' lengths</i>)</p> <p>ENLS-010 Enlighted sensor with controller unit (<i>not available on 2' & 3' lengths</i>)</p> <p>AWNRR-WH-SR Lutron Athena wireless node, RF only, white, D4i/DALI-2</p> <p>AWNRR-BL-SR Lutron Athena wireless node, RF only, black, D4i/DALI-2</p> <p>AWNRR-WH-010 Lutron Athena wireless node, RF only, white, 0-10V</p> <p>AWNRR-BL-010 Lutron Athena wireless node, RF only, black, 0-10V</p> <p>AWNRR-OCC-WH-SR Lutron Athena wireless node, Occupancy & Daylight sensor, white, D4i/DALI-2</p> <p>AWNRR-OCC-BL-SR Lutron Athena wireless node, Occu pancy & Daylight sensor, black, D4i/DALI-2</p>		<p>EMC-PF² emergency circuit requires power feed located in last fixture section (<i>for other locations consult factory</i>)</p> <p>PF² Extra power feed for additional circuiting</p> <p>EMB emergency battery pack (<i>not available for lengths under 4'</i>)</p>

1 Lengths less than 4' may have restrictions based upon wattage, lengths, drivers or other options.

2 Not available with IND (individual) configuration.

Carisma 2"

Linear Direct



PROJECT:

TYPE:

Specifications

Construction

Extruded aluminum housing and reflector. Die-cast end caps match fixture body finish.

Weight: 2.5 lbs/ft (may vary based on configurations and accessories)

Optical

All lenses are snap-in, extruded acrylic, with a maximum length of 8'. Amerlux's proprietary acrylic lens provide excellent transmission while effectively concealing source image.

PL - Performance Lens provides high efficiency with controlled lens surface brightness.

ASY - Asymmetric throw lens.

LED

Our LED binning is within 3 MacAdam ellipse. Boards are configured for maximum flexibility resulting in even illumination no matter the fixture layout. LED boards are easily replaced in the field with just a Phillips screw driver.

Color Temperature Options: 2700K*, 3000K, 3500K, 4000K

CRI: 80+, 90+

R9: 16 @ CRI 83; R9: >50 @ CRI 92

Life: 50,000+ hr., > 70% of initial lumens (L70)

* Available in 90+ CRI only

Electrical

Wiring: Individual and "Beginning of Run" (BOR) fixtures are prewired with power cord. All configurations have quick connect power harnesses for row connections. Standard Wattage: 5W/ft, 10W/ft.

Optional Wattages: 3W/ft, 4W/ft, 6W/ft, 7W/ft, 8W/ft, 9W/ft. (3W & 4W have a minimum length of 3'). For other wattages consult factory.

Emergency circuit via remote inverter or auxiliary emergency power supply (by others).

This product complies with IEEE C62.41 for surge endurance up to 2.5KV. Amerlux® recommends using additional surge protection with this unit (supplied by others), surge and over voltage damage is not covered under warranty.

EMC-PF - Emergency circuit requires power feed to be located in last fixture section for continuous runs. For other locations consult factory. Not available for individual (IND) configuration.

PF - Extra power feed for additional circuiting. Not available for individual (IND) configuration.

Finish

All painted surfaces are premium powder coated baked on for maximum durability and color stability.

HW - High reflective matte White

BT - Black Texture

ST - Silver Texture

For special paint colors supply RAL and/or actual paint chip for factory consultation.

Configurations/Lengths

Straights:

IND - Individual fixtures are made of single standard lengths of 2 ft to 8 ft (in 1' increments). These are stand alone fixtures with matching End Caps, supplied with the mounting hardware. Lengths less than 4' may have restrictions based upon wattage, lengths, drivers or other options.

CON - Continuous runs, > 8' specified to nearest whole foot length in 1' increments. Runs made from standard lengths have End Caps at the beginning and end of run. Runs > 60' may require second power feed. Each housing has factory installed alignment pins. Mating fixtures are easily aligned and joined. Wiring is made fast and positive with molded quick connectors.

CUS - Custom made to measure runs are made to nearest 1/8" of customer supplied field measurements or drawings. Custom lengths use the same hardware for hairline joining.

Patterns:

PXX - Standard Patterns consist of 90° corners with standard lengths (4' to 8' in 1' increments), continuous runs or made to measure lengths. Depending upon complexity of the pattern drawings may be required from the customer. If ordering please give overall lengths.

A'-B'-PLL - L Left - (1) 90° Corner (2) segments. Specify overall segments: A' & B'

A'-B'-PLR - L Right - (1) 90° Corner (2) segments. Specify overall segments: A' & B'

A'-B'-PR - Rectangle - (4) 90° Corners joining (4) segments. Specify overall segments: A' & B'

A'-B'-C'-PU - U shape - (2) 90° Corners joining (3) segments. Specify overall segments: A', B', & C'

A'-B'-C'-PZ - Z shape - (2) 90° Corners joining (3) segments. Specify overall segments: A', B', & C'

See page 6 for layouts.

Mounting

The Carisma Direct is intended for pendant, surface or wall mounting.

Pendant Mount-ASWxx - Direct pendant mounted in center of ceiling tile or gypsum board ceiling (standard) i.e. ASWxx. Or if canopy is installed on a grid Tee runner add, **T** i.e. ASWxxT.

Cable is stranded stainless steel wire. All fittings are protected against rust and corrosion. Canopies are 5" x 1/4" die formed painted steel. Adjustment mechanism allows for infinite height adjustment. Amerlux recommends the required feed and non-feed suspensions based upon length and electrical options. Options include: color of canopy and power cord (black or white), length 4', 10' or 20', and mounting condition, in center of ceiling tile and in gypsum board ceiling (standard) i.e. ASWxx. Or if canopy is installed on a grid Tee runner add, **T** i.e. ASWxxT

Wall Mount-WM - Direct wall mounted using steel cleat bracket attached to fixture housing and wall bracket with set screws. Two bracket assemblies are used for each length. A third center bracket may be recommended. J-box required at feed locations.

Surface Mount-SM - Direct surface mounted - housing needs to be attached to solid structure above. Mounting holes are pre-drilled at factory. Some fixture disassembly and reassembly required. Mounting hardware by others.

Options

EMB - Emergency battery pack - 10W output power, 90 min of illumination time, up to 1300 lm of initial light output. Illuminated test-switch/charging indicator light is provided. Wattage consumption by EM: 2.5W/ft (4ft fixture), 1.25W/ft (8ft fixture). Request can be made to light up 4ft section on 8ft unit.

Certifications

Approved to UL standards for damp locations as tested by CSA

Intended for indoor use only

DLC Listing pending

Warranty

Amerlux's 5 year limited warranty. Please consult Amerlux website for details.

Carisma 2"

Linear Direct



PROJECT:

TYPE:

Product Details

Pendant

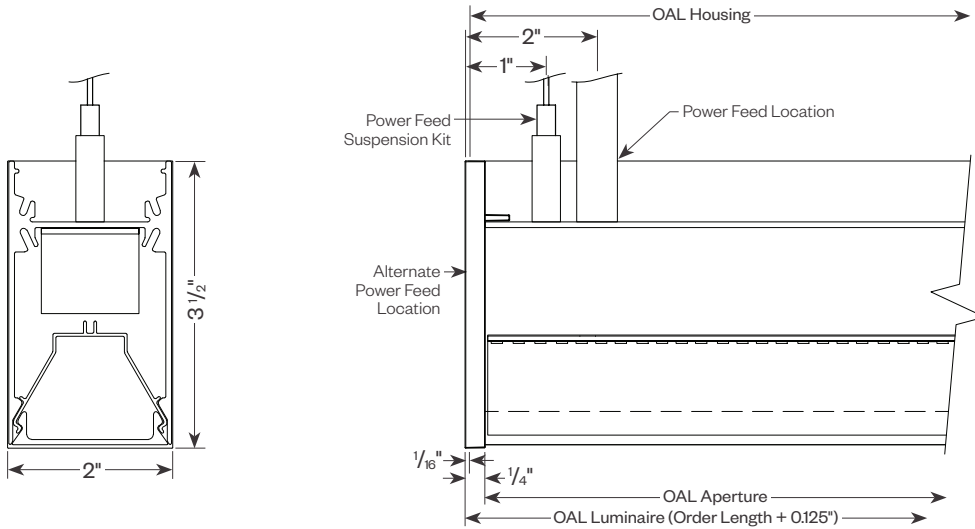

Wall Mount

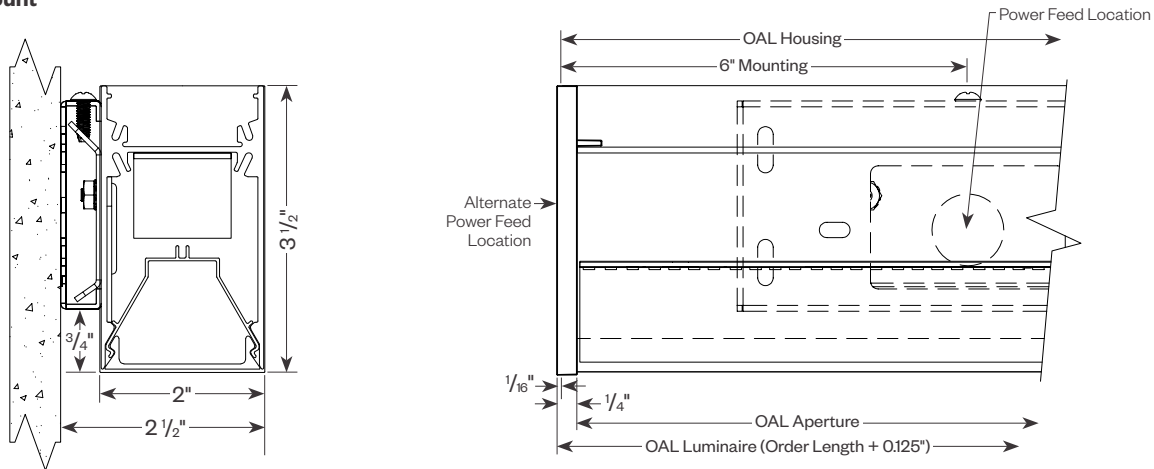

Surface Mount

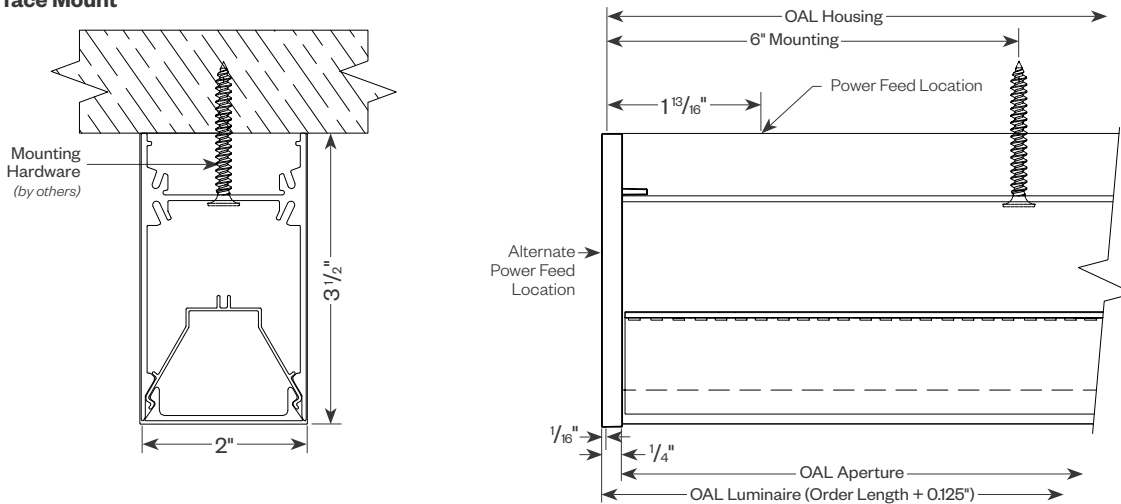

Carisma 2"

Linear Direct



PROJECT:

TYPE:

Cable Kit Suspension - Ceiling or Gypsum Board (ASW04, ASW10, ASW20, ASB04, ASB10, ASB20)

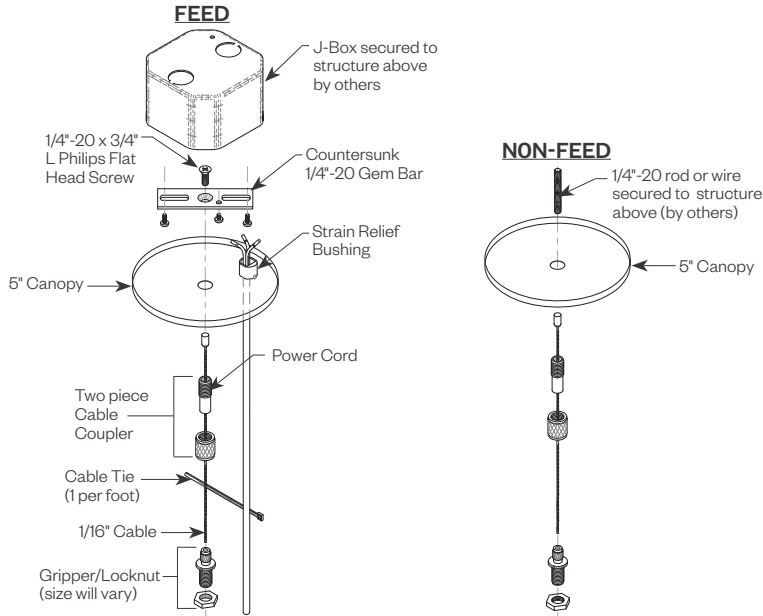

Cat#	Length	Cord/Canopy	Application
ASW04	4'	white/white	ceiling tile/gypsum
ASW10	10'	white/white	ceiling tile/gypsum
ASW20	20'	white/white	ceiling tile/gypsum
ASB04	4'	black/black	ceiling tile/gypsum
ASB10	10'	black/black	ceiling tile/gypsum
ASB20	20'	black/black	ceiling tile/gypsum
ASW04T	4'	white/white	ceiling tee
ASW10T	10'	white/white	ceiling tee
ASW20T	20'	white/white	ceiling tee
ASB04T	4'	black/black	ceiling tee
ASB10T	10'	black/black	ceiling tee
ASB20T	20'	black/black	ceiling tee

Tee Grid or Screw Slot (ASW04T, ASW10T, ASW20T, ASB04T, ASB10T, ASB20T)

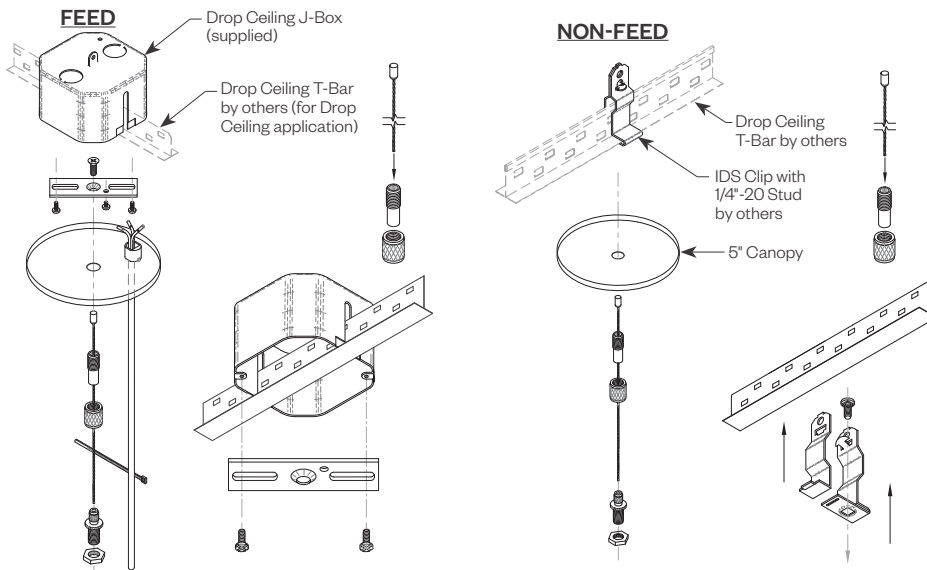

Tool-less Joining

Line up the two housings using the alignment brackets.
Secure them together by using the Catch & Latch System on the top of the extrusion.

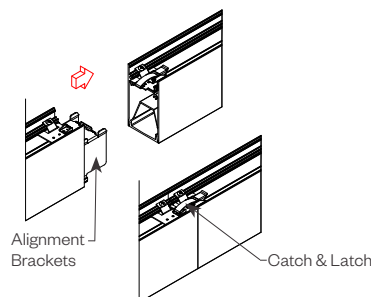

Carisma 2"

Linear Direct



PROJECT:

TYPE:

Optional Sensor/RF Node

Amerlux® has partnered with control companies to create building environments that are safer, and smarter, than ever before. At the heart of our partnership is intelligent RF nodes and Smart Sensor, the most advanced digital wireless communication and sensors available today. Integrated into Amerlux products.

Minimum run length is 3' for wireless sensor and RF node.

INDIVIDUAL (MIN 3' LENGTH)

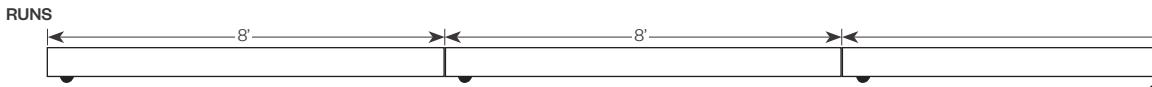

Carisma 2" Patterns

Standard Patterns

- All corners are standard 90°, standard length legs.
- Use standard lengths: 4' min to 8' in 1 foot increments.
- Continuous runs must be the same length in pairs for closed configuration.

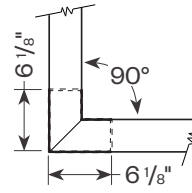

Carisma 2" Lens
Mitered Lens

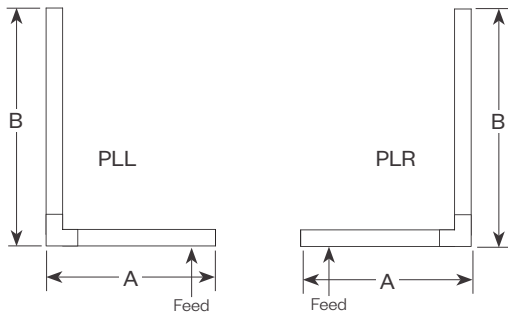

PLL - L Left, (2) straights + (1) 90° corner, leg right
PLR - L Right, (2) straights + (1) 90° corner, leg left
 Provide overall lengths: A' & B'
 Nomenclature: A-B-PLL A-B-PLR

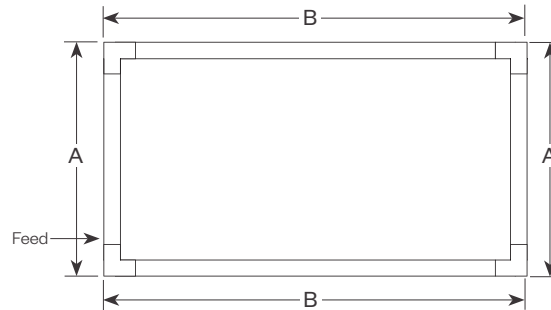

PR - Closed Rectangle, (4) straight lengths + (4) 90° corners
 Provide overall lengths: A' & B'
 Nomenclature: A-B-PR

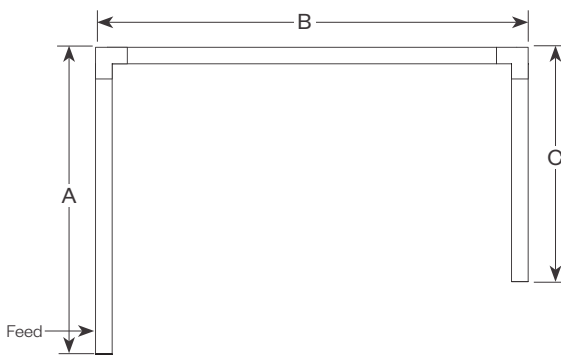

PU - Open U, (3) straight lengths + (2) 90° corners
 Provide overall lengths: A', B' & C'
 Nomenclature: A-B-C-PU

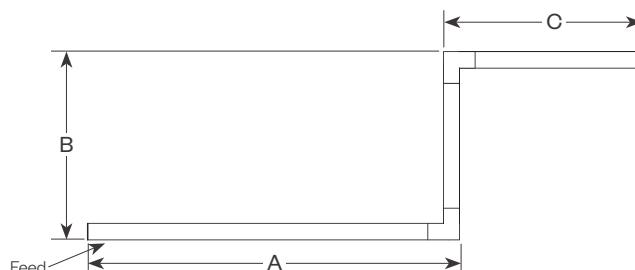

PZ - Open Z, (3) straight lengths + (2) 90° corners
 Provide overall lengths: A', B' & C'
 Nomenclature: A-B-C-PZ

Carisma 2"

Linear Direct



PROJECT:

TYPE:

Performance Data

Multiplying Factors: (Multiplying Factor is based on 3500K-80 120V IES file on website)

Wattage:	3W	4W	5W	6W	7W	8W	9W	10W
Factor:	0.59	0.78	1.0	1.20	1.40	1.60	1.79	1.98

CCT:	3000K-80	3500K-80	4000K-80	2700K-90	3000K-90	3500K-90	4000K-90
Factor:	0.97	1.0	1.02	0.90	0.92	0.92	0.94

CARISMA 2" DIRECT PERFORMANCE LENS 5W 3500K 4FT

Total Watts: 20

Total Lumens: 2,519

Source: 192 White LED's

LTL# 14656342.04

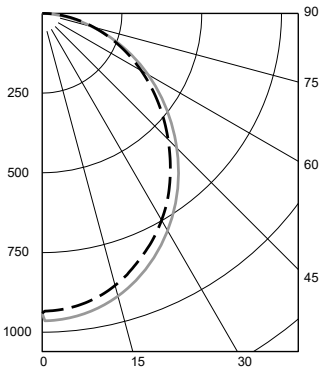

ZONAL LUMEN SUMMARY

Zone	Lumens	%Fixt
0-40	1154	45.8
0-60	1990	79.0
0-90	2519	100.0
90-180	0	0.0

Efficacy (lumens/watt) = 126.8 lm/W

COEFFICIENTS OF UTILIZATION

RC	80			
RW	70	50	30	10
RCR				
0	119	119	119	119
1	109	104	100	96
2	99	91	84	78
3	90	80	71	65
4	83	71	62	55
5	76	63	54	48
6	70	57	48	42
7	65	52	43	37
8	61	47	39	33
9	57	43	35	30
10	53	40	32	27

Note: Values expressed as % of total lumen output delivered to the task surface.

CARISMA 2" DIRECT PERFORMANCE LENS 10W 3500K 4FT

Total Watts: 39

Total Lumens: 4,755

Source: 192 White LED's

LTL# 14656342.03

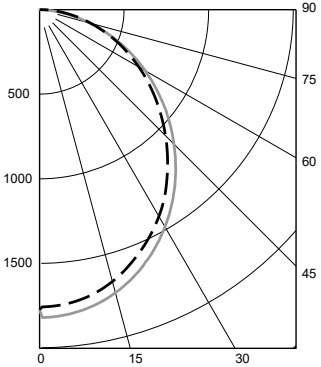

ZONAL LUMEN SUMMARY

Zone	Lumens	%Fixt
0-40	2177	45.8
0-60	3754	78.9
0-90	4755	100.0
90-180	0	0.0

Efficacy (lumens/watt) = 122.8 lm/W

COEFFICIENTS OF UTILIZATION

RC	80			
RW	70	50	30	10
RCR				
0	119	119	119	119
1	109	104	100	96
2	99	91	84	78
3	90	80	71	65
4	83	71	62	55
5	76	63	54	48
6	70	57	48	42
7	65	52	43	37
8	61	47	39	33
9	57	43	35	30
10	53	40	32	27

Note: Values expressed as % of total lumen output delivered to the task surface.

Carisma 2"

Linear Direct



PROJECT:

TYPE:

Performance Data (continued)

Multiplying Factors: (Multiplying Factor is based on 3500K-80 120V IES file on website)

Wattage:	3W	4W	5W	6W	7W	8W	9W	10W
Factor:	0.59	0.78	1.0	1.20	1.40	1.60	1.79	1.98

CCT:	3000K-80	3500K-80	4000K-80	2700K-90	3000K-90	3500K-90	4000K-90
Factor:	0.97	1.0	1.02	0.90	0.92	0.92	0.94

CARISMA 2" DIRECT ASYMMETRIC LENS 5W 3500K 4FT

Total Watts: 20

Total Lumens: 2693

Source: 192 White LED's

LTL# 15335267.01

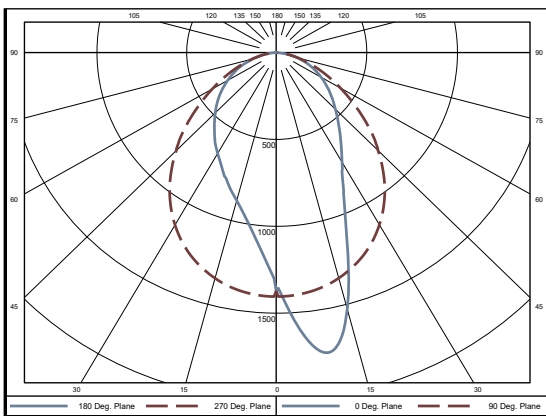

ZONAL LUMEN SUMMARY

Zone	Lumens	%Fixt
0-40	1446	53.7
0-60	2259	83.9
0-90	2692	100.0
90-180	0	0.0

Efficacy (lumens/watt) = 135.6 lm/W

COEFFICIENTS OF UTILIZATION

RC	80			
RW	70	50	30	10
RCR				
0	119	119	119	119
1	110	105	102	98
2	101	93	87	82
3	93	83	75	69
4	86	74	66	60
5	79	67	58	53
6	74	61	53	47
7	69	56	48	42
8	64	51	43	38
9	60	48	40	34
10	57	44	37	32

Note: Values expressed as % of total lumen output delivered to the task surface.

CARISMA 2" DIRECT ASYMMETRIC LENS 10W 3500K 4FT

Total Watts: 42

Total Lumens: 5408

Source: 192 White LED's

LTL# 15335267.02

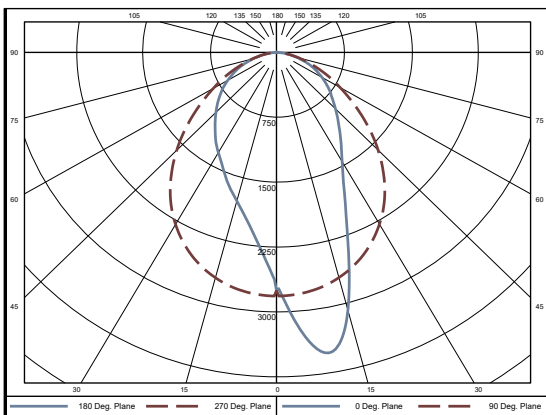

ZONAL LUMEN SUMMARY

Zone	Lumens	%Fixt
0-40	2906	53.7
0-60	4535	83.9
0-90	5408	100.0
90-180	0	0.0

Efficacy (lumens/watt) = 128.6 lm/W

COEFFICIENTS OF UTILIZATION

RC	80			
RW	70	50	30	10
RCR				
0	119	119	119	119
1	110	105	102	98
2	101	93	87	82
3	93	83	75	69
4	86	74	66	60
5	79	67	58	53
6	74	61	53	47
7	69	56	48	42
8	64	51	43	38
9	60	48	40	34
10	57	44	37	32

Note: Values expressed as % of total lumen output delivered to the task surface.

Carisma 2"

Linear Direct



PROJECT:

TYPE:

Dimming Compatibility

Amerlux® Carisma fixtures are compatible with all major dimming protocols prevalent in the United States. Please see below for general compatibilities and wiring diagrams. Amerlux recommends testing your unique dimming configuration as the exact full configuration (*Dimmer, Fixture Quantity, Voltage, etc*) may affect dimming performance.

--- NOTE: INFORMATION BELOW IS FOR WIRED DIMMERS ONLY. FOR WIRELESS DIMMERS, CONSULT FACTORY ---

0-10V - DIMMING (Standard)

Integrates into a variety of building management and daylighting controls

Notes:

- 120V or 277V*
- Dims down to 1% light output
- Requires interface to turn off power to driver
- Consult Dimming manufacturer for installation instructions - **DO NOT SHARE NEUTRALS!**

0-10V Wiring Diagram

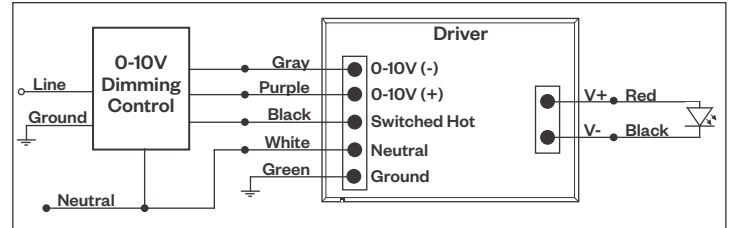

Compatible Dimmers*:

Wall Box			Central System
Lutron:	Wattstopper:	Leviton:	Lutron Grafikx Eye with GRX-TV1 Interface
Diva - DVSTV	ADF-120277	Renoir II	
Maestro - MS-Z101			
Nova-T - NTSTV-DV			

LUTRON LDE1 DIMMING

Integrates into Lutron EcoSystem building management

Notes:

- 120VAC or 277VAC*
- Dims down to 1% Soft-On/Fade-to-Black
- EcoSystem Control
- Consult Dimming manufacturer for installation instructions - **DO NOT SHARE NEUTRALS!**

LDE1 (HILUME-H-ECO) EcoSystem Digital Control Wiring Diagram

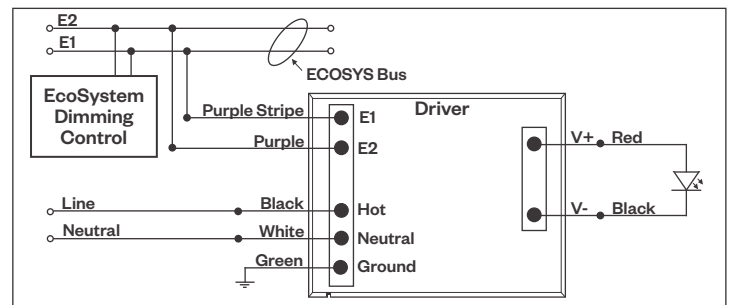

Compatible Dimmers*:

Lutron ECO System	Central System
Pow Pak Dimming Modules	Lutron EcoSystem compatible controls
Energi Savr Node	
Grafik Eye QS/Homeworks	
QS Control Unit	
Quantum Hub	
Homeworks QS/My Room	

Notes:

* Driver is 277VAC dimmable with appropriate dimmer (*by others*). All provided wiring diagrams show 120VAC wiring colors and method. Please refer to 277VAC dimmer installation instructions for 277VAC wiring diagrams.

† The absence of a dimmer from the lists above does not imply incompatibility. Please consult factory for compatibility inquiries.

Carisma 2"

Linear Direct



PROJECT:	TYPE:
-----------------	--------------

Dimming Compatibility (continued)

Amerlux® Carisma fixtures are compatible with all major dimming protocols prevalent in the United States. Please see below for general compatibilities and wiring diagrams. Amerlux recommends testing your unique dimming configuration as the exact full configuration (*Dimmer, Fixture Quantity, Voltage, etc*) may affect dimming performance.

--- NOTE: INFORMATION BELOW IS FOR WIRED DIMMERS ONLY. FOR WIRELESS DIMMERS, CONSULT FACTORY ---

DALI - DALI DIMMING 120V-277V

Digital control protocol allows individual fixture control

Notes:

- 120VAC - 277VAC*
- Dims down to 1% light output in most cases

Compatible Dimmers*:	
Wall Box	Central System
Leviton CD250 Controller	Dynalite
	Fifth Light

DALI Wiring Diagram

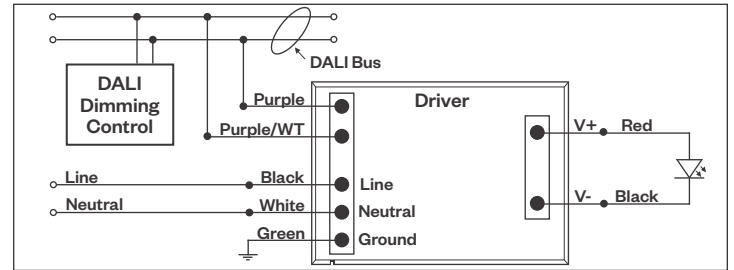

Emergency Fixture with Built-In Battery Pack

Emergency fixture with built-in battery pack (**EMB**) wiring:
 Note: EMB not available on lengths under 4'.

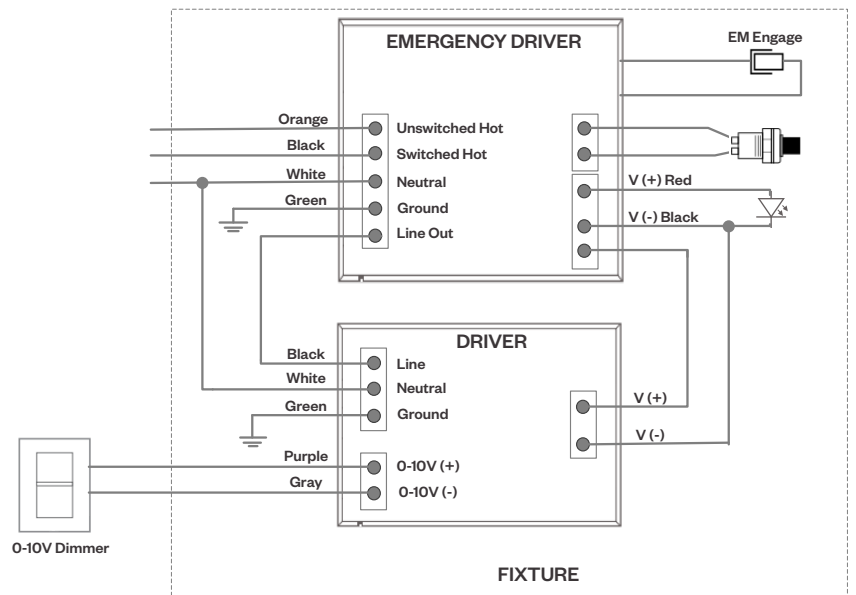

- Notes:**
- * Driver is 277VAC dimmable with appropriate dimmer (*by others*). All provided wiring diagrams show 120VAC wiring colors and method. Please refer to 277VAC dimmer installation instructions for 277VAC wiring diagrams.
 - † The absence of a dimmer from the lists above does not imply incompatibility. Please consult factory for compatibility inquiries.