

Solace

3" Shallow Round Downlights



Features

Solace 3" Downlights are the complete downlight family for any ceiling surface and low plenum ceiling. Round or Square apertures, available as downlight, adjustable or wallwash. Optional Solite lensing provides whisper quiet aesthetics. The trim options available as trimmed, trimless or millwork. The pinhole and shower pinhole trim makes this a complete a downlight to design the entire space with the same look.

Product Overview

Type:	Shallow Round Downlight
Wattage:	8, 12, 17
Max Lumen Output:	1623 lm; 96.2 lm/W (Flood optics)
CBCP:	7432 (Flood optics)
Color Temp:	2700K, 3000K, 3500K, 4000K
CRI:	83 typ. 90+ typ. CrispWhite & 3K Class A available
Dimming:	TRIAC & ELV - 5% Dim 0-10V - 1% Dim Lutron Hi-lume® H Series/EcoSystem - 1% dim with soft on Lutron Hi-lume EcoSystem Premier 0.1% dim with soft on & fade to black



Downlight
(shown with Solite lens)

Downlight Trimless

PROJECT:

TYPE:



Pinhole Downlight

Pinhole Downlight
Trimless



Pinhole Downlight Shower

Fixture Type

Round/Square	New Construction	Trimmed	Trimless	Millwork
Yes	Yes	Yes	Yes	Yes

See separate spec sheet for Square trim fixture

Performance Chart (see page 5 for full breakdown)

Watts	Delivered Lumens	LPW	CBCP	Color Temp
8	860	102	3939	3000K-83
12	1266	101	5797	3000K-83
17	1623	96	7432	3000K-83

Data is based on 3000K-83 IES files available on website.

Data is based on Flood optic (no Solite). See page 6-7 for other beam spreads.

Electrical Data

	8W		12W		17W	
	System Watts	Amps	System Watts	Amps	System Watts	Amps
120V	8	0.067	12	0.10	17	0.142
277V	8	0.029	12	0.043	17	0.061

Electronic constant current LED driver



Solace Round Downlights

3" Shallow Round Downlights



PROJECT:

TYPE:

Housing/Frame Ordering Information

1	2	3	4	5	6	7	8
<p>1 <u>Model</u> SOL-RD-NC (New Construction & Insulated Ceiling (IC rated)) SOL-RD-CP (Chicago Plenum (CCEA) housing) SOL-RD-IC (Insulated Ceiling (IC rated) & Air Tight)</p>	<p>2 <u>Style</u> T - trimmed, 2" max ceiling thickness TL - trimless, 5/8" max ceiling thickness MWK - millwork (for 1/2" - 11/16" ceiling thickness) MWK1 - millwork (for 3/4" - 1-1/2" ceiling thickness) MWK2 - millwork (for 1-1/2" - 2" ceiling thickness)</p>	<p>3 <u>Wattage</u> (3000K-83, FL beam. See pg 5 for performance table) 8 (860 lm) 12 (1266 lm) 17 (1623 lm)</p>	<p>4 <u>Voltage</u> 120/277 - universal voltage</p>	<p>5 <u>Beam Spreads</u> SP - spot, 15° FL - flood, 25° WF - wide flood, 36° VWF - very wide flood, 55°</p>	<p>6 <u>Color Temp</u> 83 CRI <u>90+ CRI</u> 27 - 2700K-83 279 - 2700K-90+ CRISP* - CrispWhite 30 - 3000K-83 309 - 3000K-90+ 3CLA* - 3K Class A 35 - 3500K-83 359 - 3500K-90+ 40* - 4000K-83 409* - 4000K-90+ * Consult factory for lead time</p>	<p>7 <u>Driver</u> (for non-dimming, select LE/TE option) LE/TE - TRIAC/ELV, 5% dim 0-10V - 0-10V, 1% dim HILUME-H-ECO - Lutron Hi-Lume EcoSystem 1% dim with soft on & fade to black HILUME-P-ECO - Lutron Hi-lume EcoSystem Premier 0.1% dim with soft on & fade to black</p>	<p>8 <u>Options</u> HB49 - hanger bars from min 29" to max 49" (26" hanger bars included as default option)</p>

Trim Ordering Information

1	2	3	4
<p>1 <u>Model</u> SOL-RD (downlight) SOL-RPD (pinhole downlight) SOL-RPDSHW (pinhole downlight shower)</p>	<p>2 <u>Style</u> T - trimmed TL - trimless (not available for use with shower trim) MWK - millwork (not available for use with shower trim)</p>	<p>3 <u>Finish - RD trim</u> <u>Trimmed</u> <u>Trimless/Millwork</u> MBW - matte black, white flange MB - matte black MWW - matte white, white flange MW - matte white SLVW - matte silver, white flange SLV - matte silver MBB - matte black, black flange SLVS - matte silver, silver flange <u>Finish - RPD/RPDSHW trims (Trimmed/Trimless/Millwork)</u> MB - matte black MW - matte white SLV - matte silver</p>	<p>4 <u>Options/Accessories</u> SOL - solite beam softening lens (comes standard with RPDSHW trim)</p>

Solace Round Downlights

3" Shallow Round Downlights



PROJECT:

TYPE:

Specifications

Application

Retail and commercial ambient and task lighting

Housing Construction

20 ga. steel painted matte black
Extruded aluminum heatsink
Formed aperture plate with 5/8" lip (GB-standard)
Cast aluminum plaster frame with perforated face (for trimless option)
Integral adjustable locking mounting bars
Inherently protected

Reflector Trim Construction

Die-cast reflector
Pinhole trim features die cast faceplate and baffle
Pinhole shower trim features solite glass lens and silicone flange gasket

Optical

Beam spreads: Spot, 15°; Flood, 25°; Wide Flood, 36°;
Very Wide Flood, 55°
Optional **SOL** - solite beam softening lens (up to ~5° widening of beam)

LED

Color Temp Options: 2700K, 3000K, 3500K, 4000K
CRI: 83 typ. (2700K, 3000K, 3500K, 4000K)
90+ typ. (2700K, 3000K, 3500K, 4000K)
CrispWhite* & Class A** 3000K (high gamut) available
R9 Values: 11 (83 CRI), 55 (92 CRI)
Binning: 3 MacAdam (SDCM)
Life: 50,000+ hrs, > 70% of initial lumens at 50,000 hrs

**CrispWhite: CrispWhite Technology delivers the warmth of colors expected from a high 90 CRI solution but also creates the natural crisp white color that is pleasing to the eye. It creates the most impactful lighting ever available, by revealing the richest whites and vibrant colors that pop.*

***Class A LED: Class A LED's have a CRI > 80 and a GAI > 80. CRI defines color "Naturalness" and GAI defines color "Saturation." Both being high delivers rich colors and pure whites.*

Electrical

Wattage: 8, 12, 17
Electronic constant current LED driver, 120/277VAC input
This product complies with IEEE C62.41 for surge endurance up to 2.5KV. Amerlux® recommends using additional surge protection with this unit (supplied by others), surge and over voltage damage is not covered under warranty.
Emergency option available through circuiting/inverter only

Drivers

LE/TE - Leading Edge, TRIAC, forward phase/Trailing Edge, ELV, reverse phase (standard)
0-10V, and Lutron systems also available
See pages 8-9 for more dimming information

Finish (Trim)

Powder coat paint

Mounting

26" Hanger bars included. Side brackets allow for rigid conduit pipe mounting along with additional 1/2" adjustment of housing vertical position
Optional **HB49** - hanger bars from min 29" to max 49" available
Trimmed Fixture:
For use in grid or sheetrock ceilings, 5/8" - 2" standard
Trimless Fixture (not available with Shower trim):
For use in sheetrock ceilings, max ceiling thickness 5/8"
For sheetrock ceilings beyond 5/8" consult factory
Millwork Fixture:
Millwork extension collars are based on ceiling material specifications and thickness. Provides flush trim appearance level with ceiling material. Max thickness 2"

Certifications

CSA damp as tested to UL 1598 standards
Wet location (SHW trim) - for indoor, high humidity/moisture from below applications only
IC/AT rated

Warranty

5 year limited warranty

Weight

Housing and trim - 5 lbs.

Solace Round Downlights

3" Shallow Round Downlights



Solace 3" Round Downlight

PROJECT:

TYPE:

Solace Round Downlights

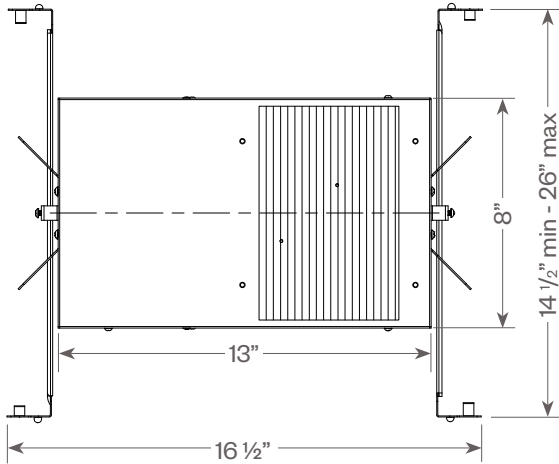

Plaster Frame Installation Detail (for trimless fixture only)

1. Reflector Trim
2. Aperture plate
3. Ceiling 5/8"
4. Cast Aluminum Plaster Frame
5. Plaster Skim Coat (by others)
6. 6-32 Type F Thread Cutting Screw

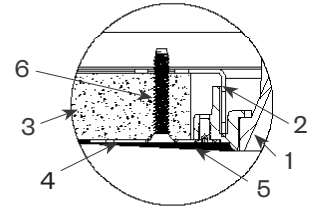

Millwork Detail

1. Reflector Trim
2. Millwork Ring
3. Aperture Plate
4. Wood Ceiling 2" Max
5. Extension collar (see ordering information for ceiling thicknesses)
6. 1/16" required for trim to be flush with ceiling

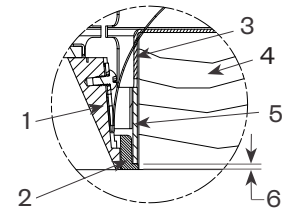

Round Downlight

Trimmed

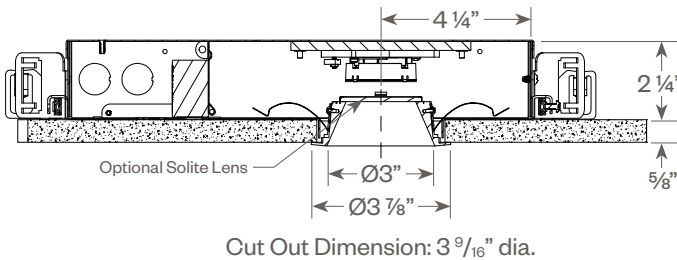

Trimless

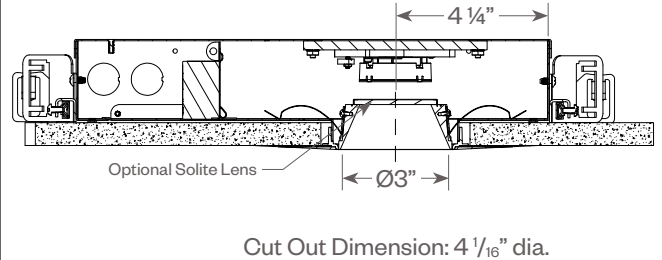

Round Pinhole Downlight

Trimmed

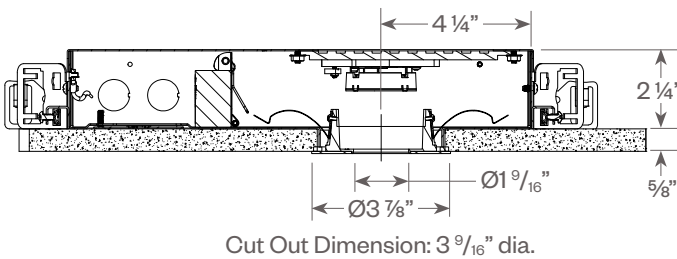

Trimless

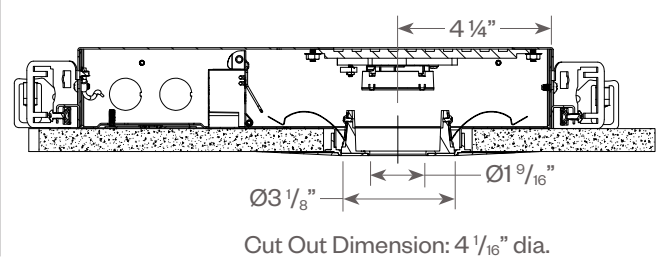

Round Pinhole Downlight Shower

Trimmed

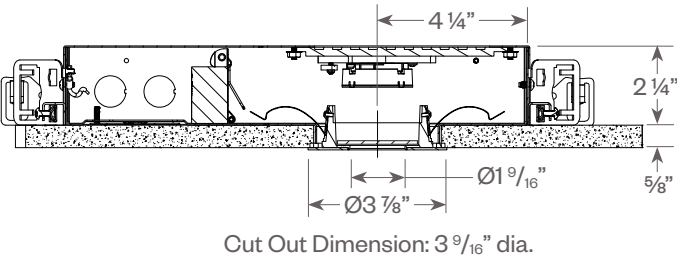

Trimless

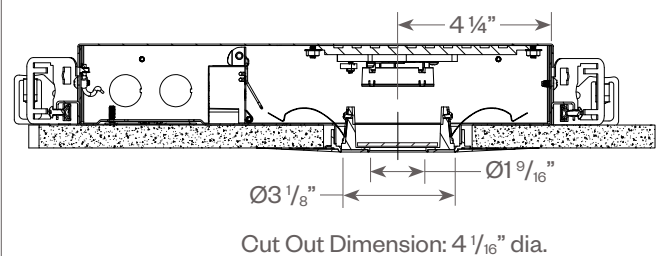

Solace Round Downlights

3" Shallow Round Downlights



PROJECT:

TYPE:

Solace Round Downlights Performance Breakdown (no Solite)

Wattage	Color Temp	SP (15°)		FL (25°)		WF (36°)		VWF (55°)		Pinhole Spot (15°)	
		Lumens	LPW	Lumens	LPW	Lumens	LPW	Lumens	LPW	Lumens	LPW
8W	27	799	95	843	100	769	92	810	96	321	38
	30	815	97	860	102	784	93	826	98	327	39
	35	831	99	877	104	800	95	843	100	334	40
	40	856	102	903	108	824	98	868	103	343	41
	279	685	82	723	86	659	78	694	83	275	33
	309	709	84	748	89	682	81	719	86	285	34
	359	734	87	774	92	706	84	744	89	294	35
	409	734	87	774	92	706	84	744	89	294	35
	CRISP	530	63	559	67	510	61	537	64	213	25
	3CLA	571	68	602	72	549	65	578	69	229	27
12W	27	1176	94	1241	99	1131	91	1192	95	472	38
	30	1200	96	1266	101	1154	92	1216	97	481	39
	35	1224	98	1291	103	1177	94	1240	99	491	39
	40	1260	101	1329	106	1212	97	1277	102	505	40
	279	1008	81	1063	85	970	78	1021	82	404	32
	309	1044	83	1101	88	1004	80	1058	85	419	34
	359	1080	86	1139	91	1039	83	1094	88	433	35
	409	1080	86	1139	91	1039	83	1094	88	433	35
	CRISP	780	62	823	66	750	60	790	63	313	25
	3CLA	840	67	886	71	808	65	851	68	337	27
17W	27	1507	89	1591	94	1450	86	1528	91	605	91
	30	1538	91	1623	96	1480	88	1559	93	617	93
	35	1569	93	1655	98	1510	90	1590	94	629	94
	40	1615	96	1704	101	1554	92	1637	97	648	97
	279	1292	76	1363	81	1243	74	1310	78	518	78
	309	1338	79	1412	84	1288	76	1356	80	537	80
	359	1384	82	1461	87	1332	79	1403	83	555	83
	409	1384	82	1461	87	1332	79	1403	83	555	83
	CRISP	1000	59	1055	63	962	57	1013	60	401	60
	3CLA	1077	64	1136	67	1036	61	1091	65	432	65

Solace Round Downlights

3" Shallow Round Downlights



PROJECT:

TYPE:

FIXTURE DATA: (Complete photometric data (.ies format) available upon request)

MULTIPLYING FACTORS: (Multiplying Factor is based on 3000K-83 120V IES file on website)

Wattage:	8W	12W	17W
Factor:	0.53	0.78	1.0

Lens:	Solite
Factor:	0.95

CCT:	2700K-83	3000K-83	3500K-83	4000K-83
Factor:	0.98	1.0	1.02	1.05

CCT:	2700K-90+	3000K-90+	3500K-90+	4000K-90+	CRISP	3CLA
Factor:	0.84	0.87	0.90	0.90	0.65	0.70

Solace Round Downlight (SOL-RD) - 17W, 3000K-83

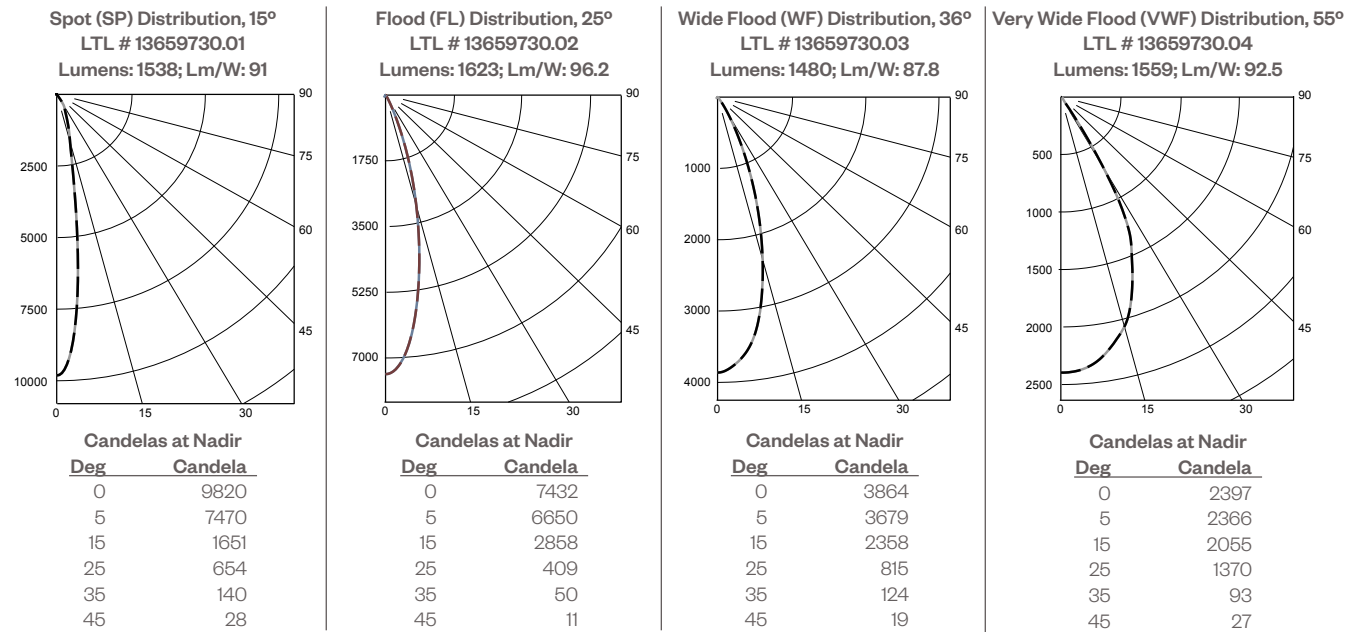

Application Data:

0° Aiming Angle
Horizontal
Footcandles

	D	FC	L	W
Spot	5.0'	393	1.3	1.3
	7.5'	175	2.0	2.0
	10.0'	99	2.9	2.9
	12.5'	63	3.4	3.4
Flood	5.0'	298	2.2	2.2
	7.5'	133	3.2	3.2
	10.0'	75	4.3	4.3
	12.5'	48	5.4	5.4
Wide Flood	5.0'	155	2.9	2.9
	7.5'	69	4.3	4.3
	10.0'	39	5.8	5.8
	12.5'	25	7.2	7.2
Very Wide Flood	5.0'	96	4.1	4.1
	7.5'	43	6.3	6.3
	10.0'	24	8.4	8.4
	12.5'	16	10.6	10.6

Notes and Definitions:

- Beam spread is to 50% center beam candlepower (CBCP).
- D=Distance to floor or wall.
- FC=Footcandles on floor or wall at center beam aiming location.
- L=Effective Visual Beam length in feet (50% of maximum footcandle level).
- W=Effective Visual Beam width in feet (50% of maximum footcandle level).
- CB=Distance across or down to center beam location.

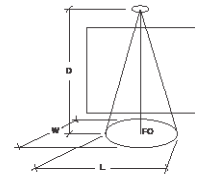

Solace Round Downlights

3" Shallow Round Downlights



PROJECT:

TYPE:

FIXTURE DATA: (Complete photometric data (.ies format) available upon request)

MULTIPLYING FACTORS: (Multiplying Factor is based on 3000K-83 120V IES file on website)

Wattage:	8W	12W	17W
Factor:	0.53	0.78	1.0

Lens:	Solite
Factor:	0.95

CCT:	2700K-83	3000K-83	3500K-83	4000K-83
Factor:	0.98	1.0	1.02	1.05

CCT:	2700K-90+	3000K-90+	3500K-90+	4000K-90+	CRISP	3CLA
Factor:	0.84	0.87	0.90	0.90	0.65	0.70

Solace Round Pinhole Downlight (SOL-RPD) - 17W, 3000K-83

Spot (SP) Distribution, 15°
LTL # 13659730.05
Lumens: 617; Lm/W: 36.6

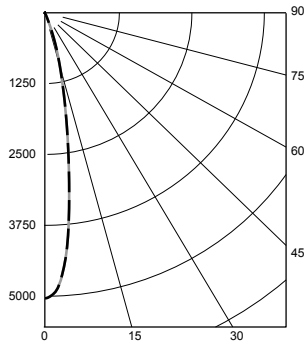

Candelas at Nadir

Deg	Candela
0	5039
5	4155
15	909
25	38
35	7
45	4

Application Data:

Spot	0° Aiming Angle Horizontal Footcandles			
	D	FC	L	W
5.0'	202	1.5	1.5	1.5
7.5'	90	2.4	2.4	2.4
10.0'	51	3.2	3.2	3.2
12.5'	32	3.8	3.8	3.8

Notes and Definitions:

Beam spread is to 50% center beam candlepower (CBCP).

D=Distance to floor or wall.

FC=Footcandles on floor or wall at center beam aiming location.

L=Effective Visual Beam length in feet (50% of maximum footcandle level).

W=Effective Visual Beam width in feet (50% of maximum footcandle level).

CB=Distance across or down to center beam location.

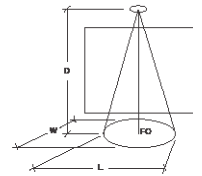

Solace Round Downlights

3" Shallow Round Downlights



PROJECT:

TYPE:

DIMMING COMPATIBILITY:

Amerlux® Solace fixtures are compatible with all major dimming protocols prevalent in the United States. Please see below for general compatibilities and wiring diagrams. Amerlux recommends testing your unique dimming configuration as the exact full configuration (Dimmer, Fixture Quantity, Voltage, etc) may affect dimming performance.

--- NOTE: INFORMATION BELOW IS FOR WIRED DIMMERS ONLY. FOR WIRELESS DIMMERS, CONSULT FACTORY ---

TRIAC (Forward Phase) DIMMING (Standard)

Utilizes "Standard" incandescent dimmers that are in wide use in installations across the US. Best for retrofit applications where TRIAC dimmers are installed.

Notes:

- 120VAC or 277VAC*
- Dims down to less than 5% light output (most cases)
- Consult Dimming manufacturer for installation instructions - DO NOT SHARE NEUTRALS!
- Must meet dimmer Minimum Load Requirements per dimming manufacturer

TRIAC Wiring Diagram

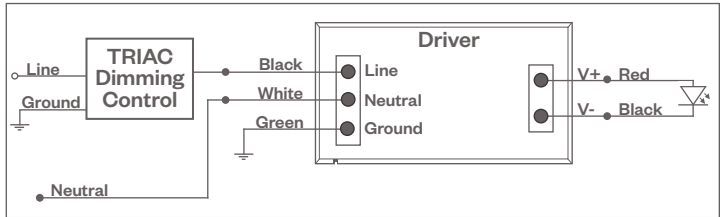

Compatible Dimmers†:

Wall Box (Incandescent Style, Wattage as required)		Central System
Lutron "Diva"	Lutron "Vareo"	Lutron "GP" Panel
Lutron "Nova-T"	Lutron "Skylark"	Lutron Grafik Eye QS
Lutron "Maestro"		

ELV - Electronic Low Voltage (Reverse Phase) DIMMING (Standard)

Utilizes specialized "ELV" dimmers.

Notes:

- 120VAC or 277VAC*
- Dims down to less than 5% light output (most cases)
- Consult Dimming manufacturer for installation instructions - DO NOT SHARE NEUTRALS!
- Must meet dimmer Minimum Load Requirements

ELV Wiring Diagram

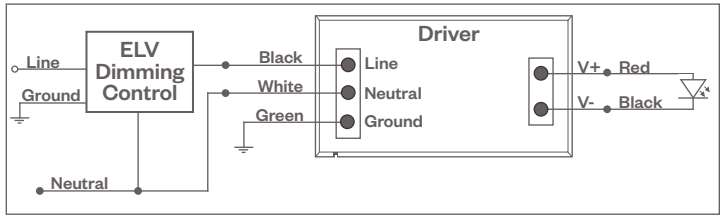

Compatible Dimmers†:

Wall Box (ELV Style)		Central System
Lutron "Diva"	Leviton "Surslide"	Lutron "GP" Panel with PHPM-PA Interface
Lutron "Nova-T"	Leviton "Vizio"	Lutron Grafik Eye QS with PHPM-PA Interface
Lutron "Maestro"		
Lutron "Vareo"		
Lutron "Skylark"		

0-10V - DIMMING (-0-10V Option)

Integrates into a variety of building management and daylighting controls

Notes:

- 120VAC or 277VAC*
- Dims down to 1% light output
- Requires interface to turn off power to driver
- Consult Dimming manufacturer for installation instructions - DO NOT SHARE NEUTRALS!

0-10V Wiring Diagram

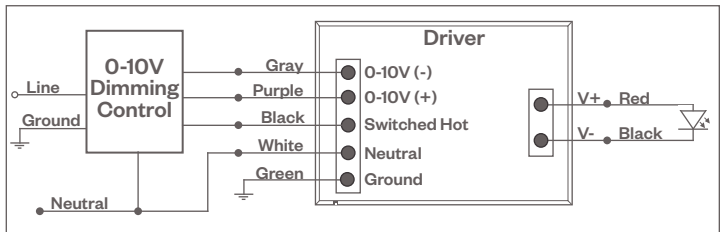

Compatible Dimmers†:

Wall Box	Central System
Lutron "Diva" - DVTV with PP-120H Interface	Leviton Renoir II 0-10V Lutron Grafik Eye with GRX-TVI Interface

Notes:

* Driver is 277VAC dimmable with appropriate dimmer (by others). All provided wiring diagrams show 120VAC wiring colors and method. Please refer to 277VAC dimmer installation instructions for 277VAC wiring diagrams.

† The absence of a dimmer from the lists above does not imply incompatibility. Please consult factory for compatibility inquiries.

Solace Round Downlights

3" Shallow Round Downlights



PROJECT:

TYPE:

DIMMING COMPATIBILITY:

Amerlux® Solace fixtures are compatible with all major dimming protocols prevalent in the United States. Please see below for general compatibilities and wiring diagrams. Amerlux recommends testing your unique dimming configuration as the exact full configuration (Dimmer, Fixture Quantity, Voltage, etc) may affect dimming performance.

--- NOTE: INFORMATION BELOW IS FOR WIRED DIMMERS ONLY. FOR WIRELESS DIMMERS, CONSULT FACTORY ---

LUTRON H-SERIES / ECOSYSTEM (-HILUME-H-ECO Option)

Integrates into Lutron EcoSystem building management

Notes:

- 120VAC or 277VAC*
- Dims down to 1% light output
- EcoSystem Control
- Consult Dimming manufacturer for installation instructions - DO NOT SHARE NEUTRALS!

Compatible Dimmers†:

Lutron ECO System

Pow Pak Dimming Modules
 Energi Savr Node
 Grafik Eye QS/Homeworks
 QS Control Unit
 Quantum Hub
 Homeworks QS/My Room

Central System

Lutron EcoSystem compatible controls

HILUME-H-ECO, HILUME-P-ECO

EcoSystem Digital Control Wiring Diagram

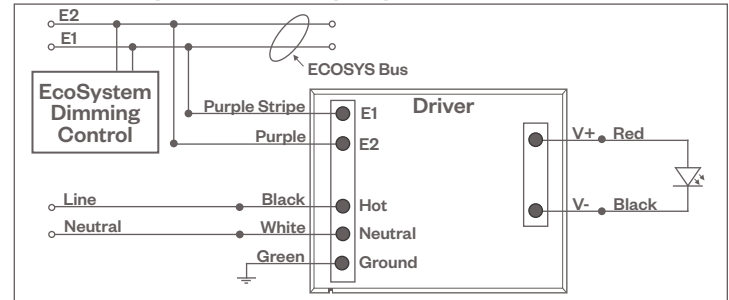

Notes:

- * Driver is 277VAC dimmable with appropriate dimmer (by others). All provided wiring diagrams show 120VAC wiring colors and method. Please refer to 277VAC dimmer installation instructions for 277VAC wiring diagrams.
- † The absence of a dimmer from the lists above does not imply incompatibility. Please consult factory for compatibility inquiries.