

Solace

3" Shallow Round Adjustables



Features

Solace 3" Downlights are the complete downlight family for any ceiling surface and low plenum ceiling. Round or Square apertures, available as downlight, adjustable or wallwash. Optional Solite lensing provides whisper quiet aesthetics. The trim options available as trimmed, trimless or millwork. The pinhole and shower pinhole trim makes this a complete a downlight to design the entire space with the same look.

Product Overview

Type:	Shallow Round Adjustable
Wattage:	8, 12, 17
Max Lumen Output:	1593 lm; 94.8 lm/W (Flood optics)
CBCP:	9443 (Flood optics)
Color Temp:	2700K, 3000K, 3500K, 4000K
CRI:	83 typ. 90+ typ. CrispWhite & 3K Class A available
Dimming:	TRIAC & ELV - 5% Dim 0-10V - 1% Dim



Adjustable



Adjustable Trimless

PROJECT:

TYPE:



Pinhole Adjustable



Pinhole Adjustable Trimless



Pinhole Adjustable Shower

Fixture Type

Round/Square	New Construction	Trimmed	Trimless	Millwork
Yes	Yes	Yes	Yes	Yes

See separate spec sheet for Square trim fixture

Performance Chart (see page 5 for full breakdown)

Watts	Delivered Lumens	LPW	CBCP	Color Temp
8	844	101	5005	3000K-83
12	1243	99	7365	3000K-83
17	1593	95	9443	3000K-83

Data is based on 3000K-83 IES files available on website.

Data is Flood optic (no Solite). See page 6-8 for other beam spreads.

Electrical Data

	8W		12W		17W	
	System Watts	Amps	System Watts	Amps	System Watts	Amps
120V	8	0.067	12	0.10	17	0.142
277V	8	0.029	12	0.043	17	0.061

Electronic constant current LED driver



Solace Round Adjustables

3" Shallow Round Adjustables



PROJECT:

TYPE:

Specifications

Application

Retail and commercial accent and display lighting

Housing Construction

20 ga. steel painted matte black
Extruded aluminum heatsink
Formed aperture plate with 5/8" lip (GB-standard)
Cast aluminum plaster frame with perforated face (for trimless option)
Integral adjustable locking mounting bars
Inherently protected

Reflector Trim Construction

Die-cast reflector
Pinhole Trim features stamped faceplate and die cast baffle
Pinhole Adjustable Shower trim features solite glass lens and silicone flange gasket

Optical

0-40° lockable tilt, 360° lockable rotation, and lockable aiming (ceiling thickness greater than 1" will affect max angle adjustment)
Beam spreads: Spot, 15°; Flood, 25°; Wide Flood, 36°; Very Wide Flood, 55°
Optional **SOL** - solite beam softening lens (up to ~5° widening of beam)

LED

Color Temp Options: 2700K, 3000K, 3500K, 4000K
CRI: 83 typ. (2700K, 3000K, 3500K, 4000K)
90+ typ. (2700K, 3000K, 3500K, 4000K)
CrispWhite* & Class A** 3000K (high gamut) available
R9 Values: 11 (83 CRI), 55 (92 CRI)
Binning: 3 MacAdam (SDCM)
Life: 50,000+ hrs, > 70% of initial lumens at 50,000 hrs

**CrispWhite: CrispWhite Technology delivers the warmth of colors expected from a high 90 CRI solution but also creates the natural crisp white color that is pleasing to the eye. It creates the most impactful lighting ever available, by revealing the richest whites and vibrant colors that pop.*

***Class A LED: Class A LED's have a CRI > 80 and a GAI > 80. CRI defines color "Naturalness" and GAI defines color "Saturation." Both being high delivers rich colors and pure whites.*

Electrical

Wattage: 8, 12, 17
Electronic constant current LED driver, 120/277VAC input
This product complies with IEEE C62.41 for surge endurance up to 2.5KV. Amerlux® recommends using additional surge protection with this unit (supplied by others), surge and over voltage damage is not covered under warranty.
Emergency option available through circuiting/inverter only

Drivers

LE/TE - Leading Edge, TRIAC, forward phase/Trailing Edge, ELV, reverse phase (standard)
0-10V also available
See pages 9-10 for more dimming information

Finish (Trim)

Powder coat paint

Mounting

26" Hanger bars included. Side brackets allow for rigid conduit pipe mounting along with additional 1/2" adjustment of housing vertical position
Optional **HB49** - hanger bars from min 29" to max 49" available
Trimmed Fixture:
For use in grid or sheetrock ceilings, 5/8" - 2" standard
Note: Ceiling thickness greater than 1" will affect max angle adjustment
Trimless Fixture (not available with Shower trim):
For use in sheetrock ceilings, max ceiling thickness 5/8"
For sheetrock ceilings beyond 5/8" consult factory

Millwork Fixture:

Millwork extension collars are based on ceiling material specifications and thickness. Provides flush trim appearance level with ceiling material. Max thickness 2".

Note: Ceiling thickness greater than 1" will affect max angle adjustment

Certifications

CSA damp as tested to UL 1598 standards
Wet location (SHW trim) - for indoor, high humidity/moisture from below applications only
IC/AT rated

Warranty

5 year limited warranty

Weight

Housing and trim - 7 lbs.

Solace Round Adjustables

3" Shallow Round Adjustables



PROJECT:

TYPE:

Solace Round Adjustable

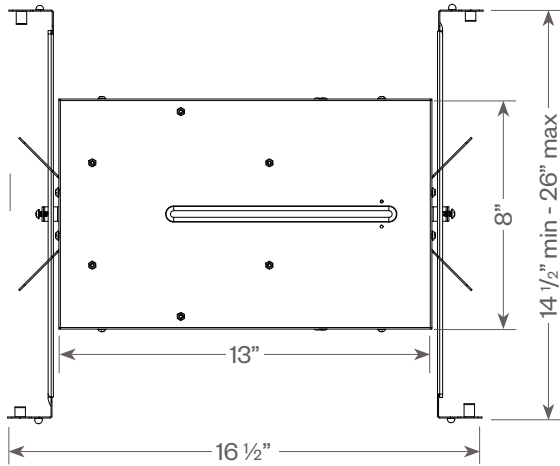

Plaster Frame Installation Detail (for trimless fixture only)

1. Reflector Trim
2. Aperture plate
3. Ceiling 5/8"
4. Cast Aluminum Plaster Frame
5. Plaster Skim Coat (by others)
6. 6-32 Type F Thread Cutting Screw

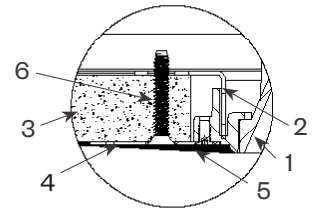

Millwork Detail

1. Reflector Trim
2. Millwork Ring
3. Aperture Plate
4. Wood Ceiling 2" Max
5. Extension collar (see ordering information for ceiling thicknesses)
6. 1/16" required for trim to be flush with ceiling

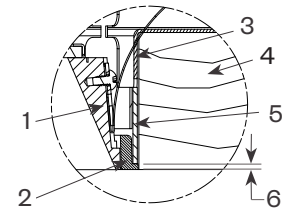

Round Adjustable

Trimmed

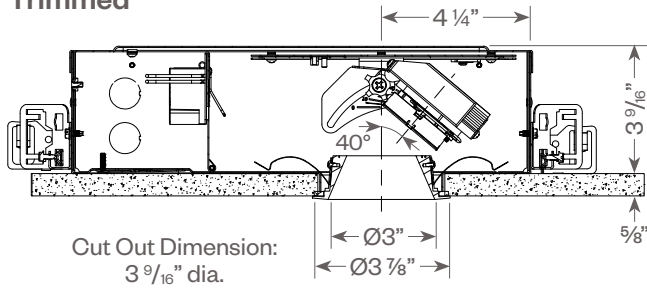

Trimless

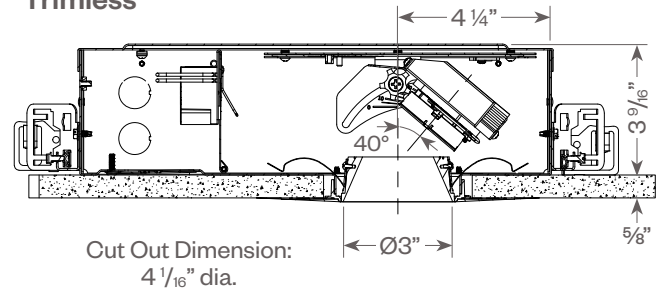

Round Pinhole Adjustable

Trimmed

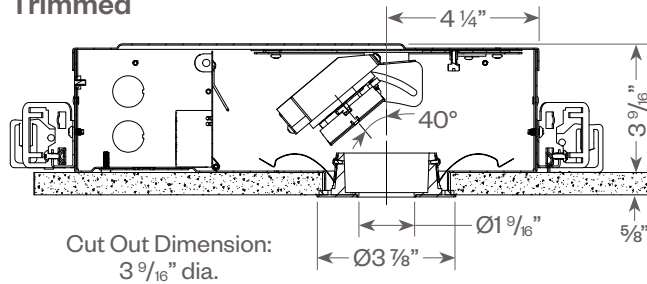

Trimless

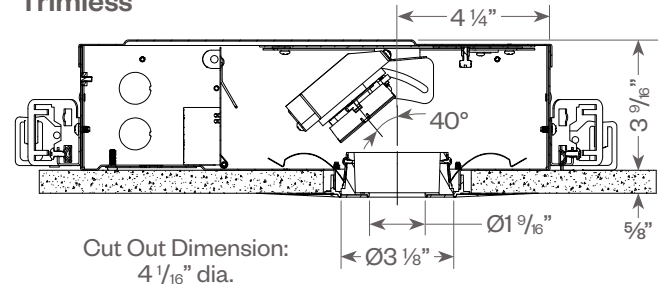

Round Pinhole Adjustable Shower

Trimmed

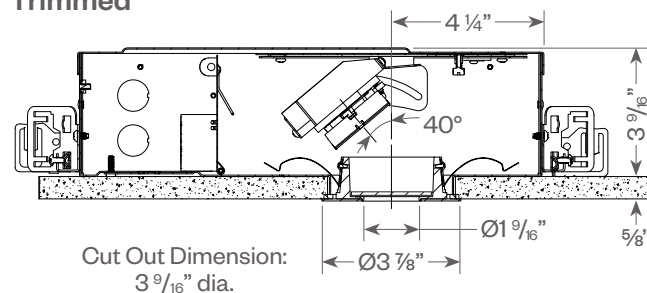

Trimless

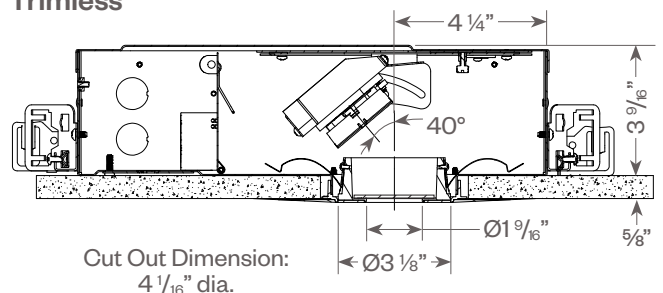

Solace Round Adjustables

3" Shallow Round Adjustables



PROJECT:

TYPE:

Solace Round Downlights Performance Breakdown (no Solite)

Wattage	Color Temp	SP (15°)		FL (25°)		WF (36°)		VWF (55°)		Pinhole Spot (15°)	
		Lumens	LPW	Lumens	LPW	Lumens	LPW	Lumens	LPW	Lumens	LPW
8W	27	783	93	827	99	752	89	797	95	322	38
	30	799	95	844	101	767	91	814	97	329	39
	35	815	97	861	103	782	93	830	99	335	40
	40	839	100	887	106	805	96	854	102	345	41
	279	671	80	709	84	644	77	683	81	276	33
	309	695	83	735	87	667	79	708	84	286	34
	359	719	86	760	90	690	82	732	87	296	35
	409	719	86	760	90	690	82	732	87	296	35
	CRISP	520	62	549	65	498	59	529	63	214	25
	3CLA	559	67	591	70	537	64	569	68	230	27
12W	27	1153	92	1218	97	1106	88	1173	94	474	38
	30	1176	94	1243	99	1129	90	1197	96	484	39
	35	1200	96	1267	101	1151	92	1221	98	493	39
	40	1235	99	1305	104	1185	95	1257	101	508	41
	279	988	79	1044	83	948	76	1006	80	406	32
	309	1023	82	1081	86	982	79	1042	83	421	34
	359	1059	85	1118	89	1016	81	1078	86	435	35
	409	1059	85	1118	89	1016	81	1078	86	435	35
	CRISP	765	61	808	65	734	59	778	62	314	25
	3CLA	823	66	870	70	790	63	838	67	339	27
17W	27	1478	88	1561	93	1418	84	1504	89	608	36
	30	1508	90	1593	95	1447	86	1535	91	620	37
	35	1538	92	1625	97	1476	88	1566	93	632	38
	40	1583	94	1673	100	1519	90	1612	96	651	39
	279	1267	76	1338	80	1215	72	1289	77	521	31
	309	1312	78	1386	82	1259	75	1335	79	539	32
	359	1357	81	1434	85	1302	77	1382	82	558	33
	409	1357	81	1434	85	1302	77	1382	82	558	33
	CRISP	980	58	1035	62	941	56	998	59	403	24
	3CLA	v	63	1115	66	1013	60	1075	64	434	26

Solace Round Adjustables

3" Shallow Round Adjustables



PROJECT:

TYPE:

FIXTURE DATA: (Complete photometric data (.ies format) available upon request)

MULTIPLYING FACTORS: (Multiplying Factor is based on 3000K-83 120V IES file on website)

Wattage:	8W	12W	17W
Factor:	0.53	0.78	1.0

Lens:	Solite
Factor:	0.95

CCT:	2700K-83	3000K-83	3500K-83	4000K-83
Factor:	0.98	1.0	1.02	1.05

CCT:	2700K-90+	3000K-90+	3500K-90+	4000K-90+	CRISP	3CLA
Factor:	0.84	0.87	0.90	0.90	0.65	0.70

Solace Round Adjustable (SOL-RA) - 17W, 3000K-83, 0° Tilt Angle

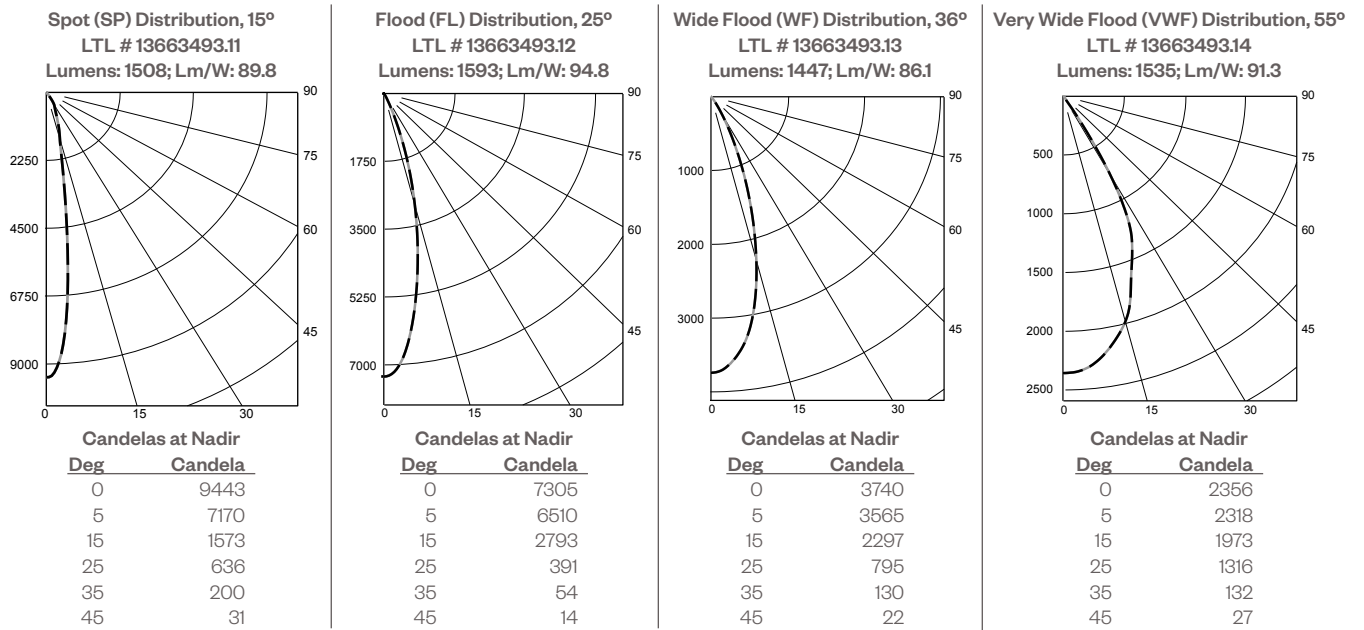

Application Data:

0° Aiming Angle
Horizontal
Footcandles

	D	FC	L	W
Spot	5.0'	378	1.3	1.3
	7.5'	168	2.0	2.0
	10.0'	95	2.8	2.8
	12.5'	61	3.4	3.4
Flood	5.0'	293	2.1	2.1
	7.5'	130	3.2	3.2
	10.0'	73	4.3	4.3
	12.5'	47	5.3	5.3
Wide Flood	5.0'	150	3.0	3.0
	7.5'	67	4.4	4.4
	10.0'	38	5.8	5.8
	12.5'	24	7.3	7.3
Very Wide Flood	5.0'	95	4.0	4.0
	7.5'	42	6.1	6.1
	10.0'	24	8.2	8.2
	12.5'	15	10.3	10.5

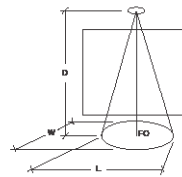

Notes and Definitions:

- Beam spread is to 50% center beam candlepower (CBCP).
- D=Distance to floor or wall.
- FC=Footcandles on floor or wall at center beam aiming location.
- L=Effective Visual Beam length in feet (50% of maximum footcandle level).
- W=Effective Visual Beam width in feet (50% of maximum footcandle level).
- CB=Distance across or down to center beam location.

Solace Round Adjustables

3" Shallow Round Adjustables



PROJECT:

TYPE:

FIXTURE DATA: (Complete photometric data (.ies format) available upon request)

MULTIPLYING FACTORS: (Multiplying Factor is based on 3000K-83 120V IES file on website)

Wattage:	8W	12W	17W
Factor:	0.53	0.78	1.0

Lens:	Solite
Factor:	0.95

CCT:	2700K-83	3000K-83	3500K-83	4000K-83
Factor:	0.98	1.0	1.02	1.05

CCT:	2700K-90+	3000K-90+	3500K-90+	4000K-90+	CRISP	3CLA
Factor:	0.84	0.87	0.90	0.90	0.65	0.70

Solace Round Adjustable (SOL-RA) - 17W, 3000K-83, 20° (approx.) Tilt Angle

Spot (SP) Distribution, 15°
LTL # 13663493.01
Lumens: 1252; Lm/W: 74.2

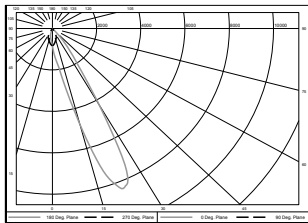

Candelas at Nadir	
Deg	Candela
0	826
5	1411
15	4781
25	8076
35	1623
45	67

Flood (FL) Distribution, 25°
LTL # 13663493.02
Lumens: 1411; Lm/W: 83.6

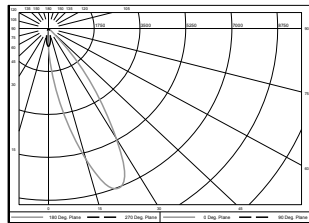

Candelas at Nadir	
Deg	Candela
0	748
5	2033
15	5526
25	6833
35	3156
45	234

Wide Flood (WF) Distribution, 36°
LTL # 13663493.03
Lumens: 1262; Lm/W: 74.8

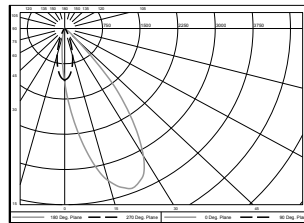

Candelas at Nadir	
Deg	Candela
0	1120
5	1920
15	3353
25	3566
35	2302
45	342

Very Wide Flood (VWF) Distribution, 55°
LTL # 13663493.04
Lumens: 1259; Lm/W: 74.7

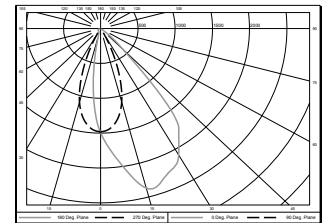

Candelas at Nadir	
Deg	Candela
0	1496
5	1788
15	2369
25	2241
35	1828
45	430

Application Data:



23° Aiming Angle
Horizontal
Footcandles



23° Aiming Angle
Vertical
Footcandles

	Horizontal Footcandles					Vertical Footcandles				
	D	FC	L	W	CB	D	FC	L	W	CB
Spot	5.0'	267	1.5	1.4	2.0	3.0'	53	4.4	2.3	6.5
	7.5'	119	2.6	1.9	3.0	4.0'	33	5.7	2.9	8.5
	10.0'	67	3.3	2.7	4.0	5.0'	23	7.1	3.3	10.5
	12.5'	43	4.1	3.3	5.0	6.0'	16	8.5	3.7	12.5
Flood	5.0'	226	2.4	2.3	2.0	3.0'	61	4.5	2.9	5.5
	7.5'	100	3.6	3.3	3.0	4.0'	36	5.9	3.7	6.5
	10.0'	57	4.8	4.4	4.0	5.0'	24	7.4	4.5	8.5
	12.5'	36	6.0	5.5	5.0	6.0'	17	9.0	5.2	10.5
Wide Flood	5.0'	117	3.1	3.0	2.0	3.0'	42	4.2	3.2	4.5
	7.5'	54	4.6	4.3	2.0	4.0'	25	5.5	4.1	5.5
	10.0'	31	6.1	5.7	3.0	5.0'	17	6.5	5.1	7.5
	12.5'	20	7.7	7.2	4.0	6.0'	12	8.0	6.1	8.5
Very Wide Flood	5.0'	83	3.8	4.0	1.0	3.0'	34	3.7	3.6	4.5
	7.5'	38	5.6	5.9	2.0	4.0'	22	4.5	4.5	5.5
	10.0'	21	7.7	8.0	3.0	5.0'	14	5.6	5.9	6.5
	12.5'	14	9.6	10.1	3.0	6.0'	10	6.9	7.0	8.5

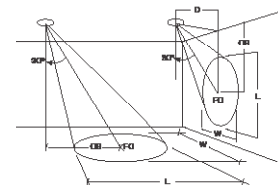

Notes and Definitions:

- Beam spread is to 50% center beam candlepower (CBCP).
- D=Distance to floor or wall.
- FC=Footcandles on floor or wall at center beam aiming location.
- L=Effective Visual Beam length in feet (50% of maximum footcandle level).
- W=Effective Visual Beam width in feet (50% of maximum footcandle level).
- CB=Distance across or down to center beam location.

Solace Round Adjustables

3" Shallow Round Adjustables



PROJECT:

TYPE:

FIXTURE DATA: (Complete photometric data (.ies format) available upon request)

MULTIPLYING FACTORS: (Multiplying Factor is based on 3000K-83 120V IES file on website)

Wattage:	8W	12W	17W
Factor:	0.53	0.78	1.0

Lens:	Solite
Factor:	0.95

CCT:	2700K-83	3000K-83	3500K-83	4000K-83
Factor:	0.98	1.0	1.02	1.05

CCT:	2700K-90+	3000K-90+	3500K-90+	4000K-90+	CRISP	3CLA
Factor:	0.84	0.87	0.90	0.90	0.65	0.70

Solace Round Pinhole Adjustable (SOL-RPA) - 17W, 3000K-83

0° Tilt Angle
Spot (SP) Distribution, 15°
LTL # 13663493.19
Lumens: 620; Lm/W: 36.9

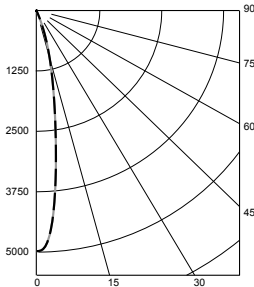

Candelas at Nadir

Deg	Candela
0	4979
5	3979
15	949
25	42
35	7
45	4

20° (approx.) Tilt Angle
Spot (SP) Distribution, 15°
LTL # 13663493.09
Lumens: 495; Lm/W: 29.4

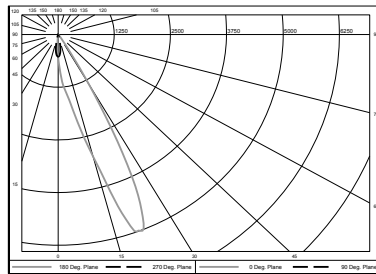

Candelas at Nadir

Deg	Candela
0	540
5	1181
15	2990
25	4214
35	173
45	16

Application Data:

0° Aiming Angle
Horizontal
Footcandles

Spot	D	FC	L	W
5.0'	5.0'	200	1.5	1.5
7.5'	7.5'	89	2.3	2.3
10.0'	10.0'	50	3.1	3.1
12.5'	12.5'	32	3.7	3.7

Spot	23° Aiming Angle Horizontal Footcandles					23° Aiming Angle Vertical Footcandles				
	D	FC	L	W	CB	D	FC	L	W	CB
5.0'	161	1.5	1.4	2.0	3.0'	27	4.0	2.1	6.5	
7.5'	72	2.4	1.9	3.0	4.0'	17	5.0	2.8	8.5	
10.0'	40	3.1	2.7	4.0	5.0'	11	6.4	3.3	10.5	
12.5'	26	4.0	3.5	5.0	6.0'	8	7.9	3.9	12.5	

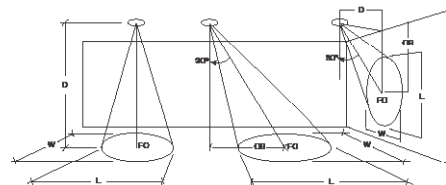

Notes and Definitions:

- Beam spread is to 50% center beam candlepower (CBCP).
- D=Distance to floor or wall.
- FC=Footcandles on floor or wall at center beam aiming location.
- L=Effective Visual Beam length in feet (50% of maximum footcandle level).
- W=Effective Visual Beam width in feet (50% of maximum footcandle level).
- CB=Distance across or down to center beam location.

Solace Round Adjustables

3" Shallow Round Adjustables



PROJECT:

TYPE:

DIMMING COMPATIBILITY:

Amerlux® Solace fixtures are compatible with all major dimming protocols prevalent in the United States. Please see below for general compatibilities and wiring diagrams. Amerlux recommends testing your unique dimming configuration as the exact full configuration (Dimmer, Fixture Quantity, Voltage, etc) may affect dimming performance.

--- NOTE: INFORMATION BELOW IS FOR WIRED DIMMERS ONLY. FOR WIRELESS DIMMERS, CONSULT FACTORY ---

TRIAC (Forward Phase) DIMMING (Standard)

Utilizes "Standard" incandescent dimmers that are in wide use in installations across the US. Best for retrofit applications where TRIAC dimmers are installed.

Notes:

- 120VAC or 277VAC*
- Dims down to less than 5% light output (most cases)
- Consult Dimming manufacturer for installation instructions - DO NOT SHARE NEUTRALS!
- Must meet dimmer Minimum Load Requirements per dimming manufacturer

TRIAC Wiring Diagram

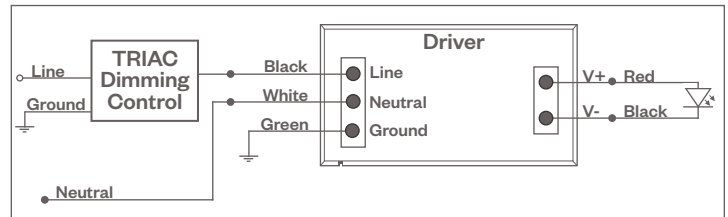

Compatible Dimmers†:

Wall Box (Incandescent Style, Wattage as required)		Central System
Lutron "Diva"	Lutron "Vareo"	Lutron "GP" Panel
Lutron "Nova-T"	Lutron "Skylark"	Lutron Grafik Eye QS
Lutron "Maestro"		

ELV - Electronic Low Voltage (Reverse Phase) DIMMING (Standard)

Utilizes specialized "ELV" dimmers.

Notes:

- 120VAC or 277VAC*
- Dims down to less than 5% light output (most cases)
- Consult Dimming manufacturer for installation instructions - DO NOT SHARE NEUTRALS!
- Must meet dimmer Minimum Load Requirements

ELV Wiring Diagram

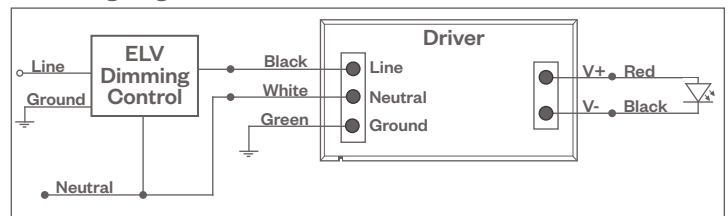

Compatible Dimmers†:

Wall Box (ELV Style)		Central System
Lutron "Diva"	Leviton "Surslide"	Lutron "GP" Panel with PHPM-PA Interface
Lutron "Nova-T"	Leviton "Vizio"	Lutron Grafik Eye QS with PHPM-PA Interface
Lutron "Maestro"		
Lutron "Vareo"		
Lutron "Skylark"		

0-10V - DIMMING (-0-10V Option)

Integrates into a variety of building management and daylighting controls

Notes:

- 120VAC or 277VAC*
- Dims down to 1% light output
- Requires interface to turn off power to driver
- Consult Dimming manufacturer for installation instructions - DO NOT SHARE NEUTRALS!

0-10V Wiring Diagram

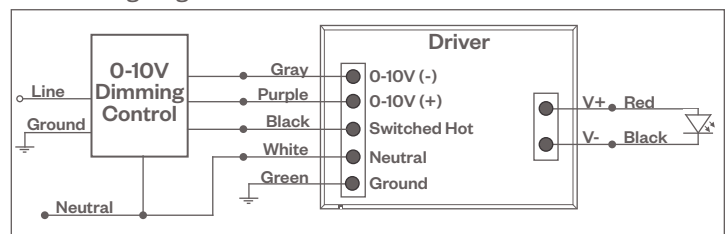

Compatible Dimmers†:

Wall Box	Central System
Lutron "Diva" - DVTV with PP-120H Interface	Leviton Renoir II 0-10V Lutron Grafik Eye with GRX-TVI Interface

Notes:

- * Driver is 277VAC dimmable with appropriate dimmer (by others). All provided wiring diagrams show 120VAC wiring colors and method. Please refer to 277VAC dimmer installation instructions for 277VAC wiring diagrams.
- † The absence of a dimmer from the lists above does not imply incompatibility. Please consult factory for compatibility inquiries.