

Hornet® HP Select

Round Lensed Downlight



HSE-R-LD.T (trimmed)

Features

The Hornet HP Select round downlight series provides powerful yet comfortable ambient lighting for retail and commercial spaces without compromising on budget or design. It delivers over 2,200 lumens in a 75-degree distribution and features Solite lensing for visually pleasing aesthetics. The Hornet HP Select offers trimmed, trimless, or millwork trim options and can easily integrate into current Hornet downlight platforms, making it perfect for both retrofit and new construction projects.

Product Overview

- Type: Recessed Round Lensed Downlight
- Wattage: 9, 12, 16, 23
- Color Temp: 2700K, 3000K, 3500K, 4000K
- CRI: 83 typ. or 90+ typ.
- Dimming: TRIAC & ELV (120/277VAC) - 5% Dim
Lutron LDE1 Hi-lume® 1% Soft-On/Fade-to-Black (120/277VAC)
0-10V (120/277VAC) - 1% Dim
DALI (120/277VAC) - 1% Dim

PROJECT:



HSE-R-LD.TL (trimless)

TYPE:



HSE-R-LD.MWK (millwork)

Performance Chart

Watts	Delivered Lumens	LPW	CBCP	Color Temp
9	855	95	665	3000K-83
12	1140	95	887	3000K-83
16	1513	94.6	1177	3000K-83
23	2192	100.2	1706	3000K-83

Data is based on 3000K-83 IES files available on website
All wattage and LPW includes 2W thermal protector

Electrical Data

	9W		12W		16W		23W	
	System Watts	Amps	System Watts	Amps	System Watts	Amps	System Watts	Amps
120V	9.8	0.08	11.9	0.10	15.2	0.13	22.8	0.19
277V	9.8	0.04	11.9	0.04	15.2	0.06	22.8	0.08

Electronic constant current LED driver
Includes thermal protector, 2W power consumption



Hornet® HP Select

Round Lensed Downlight



PROJECT:

TYPE:

Housing/Frame Ordering Information

1	2	3	4	5	6
1 Model <u>For New Construction</u> HDL-HP-R-NC-A17 (New Construction) HDL-HP-R-CP-A17 (Chicago Plenum (CCEA) housing) HDL-HP-R-IC-A17 (Insulated Ceiling/air tight, 16W max) <u>For Existing Ceilings</u> HDL-HP-R-REM-A17 (Remodeler)	2 Style T trimmed TL trimless MWK ^{R†} millwork (for 1/2"-11/16" ceiling thickness) ^R Not available for use with Remodeler model [‡] Consult factory for use in ceilings thicker than 11/16"	3 Wattage 9 12 16 23* * Not available for use with IC housing	4 Voltage 120 277 120/277 (for use with IC housing only)	5 Driver LE/TE TRIAC/ELV dimming 0-10V 0-10V dimming, 1% dim DALI DALI dimming, 1% dim HILUME-H-ECO Lutron LDE1 Hi-lume® 1% Soft-On/Fade-to-Black	6 Options/Accessories EM emergency battery pack with remote test switch (not available for use with CP or IC options) HB49 hanger bars from min 29" to max 49"

Trim Ordering Information

1	2	3	4	5										
HSE-R-LD	75SOL	1	2	3										
1 Model HSE-R-LD lensed downlight	2 Style T trimmed TL trimless MWK millwork	3 Finish <u>Trimmed</u> MBW matte black, white flange MWW matte white, white flange SLVW matte silver, white flange MBB matte black, black flange SLVS matte silver, silver flange <u>Trimless/Millwork</u> MB matte black MW matte white SLV matte silver	4 Beam Spread 75SOL 75° beam with solite lens	5 Color Temp-CRI <table style="width: 100%; border-collapse: collapse;"> <tr> <td style="width: 50%;"><u>83 CRI</u></td> <td style="width: 50%;"><u>90+ CRI</u></td> </tr> <tr> <td>27 2700K-83</td> <td>279 2700K-90+</td> </tr> <tr> <td>30 3000K-83</td> <td>309 3000K-90+</td> </tr> <tr> <td>35 3500K-83</td> <td>359 3500K-90+</td> </tr> <tr> <td>40 4000K-83</td> <td>409 4000K-90+</td> </tr> </table>	<u>83 CRI</u>	<u>90+ CRI</u>	27 2700K-83	279 2700K-90+	30 3000K-83	309 3000K-90+	35 3500K-83	359 3500K-90+	40 4000K-83	409 4000K-90+
<u>83 CRI</u>	<u>90+ CRI</u>													
27 2700K-83	279 2700K-90+													
30 3000K-83	309 3000K-90+													
35 3500K-83	359 3500K-90+													
40 4000K-83	409 4000K-90+													

Hornet® HP Select

Round Lensed Downlight



PROJECT:

TYPE:

Specifications

Application

Retail and commercial ambient lighting

Construction

- 20 ga. galvanized steel frame
- 18 ga. galvanized steel splice housing and hanger brackets (not for Remodeler version)
- Cast aluminum plaster frame with perforated face (for trimless version only)
- Die-cast optical housing and trim
- Die-cast heat sink

Optical

- Beam Spread-Lens:
 - 75SOL - 75° beam with solite lens
 - Visually best with SLV reflector finish.

LED

- Color Temp Options: 2700K, 3000K, 3500K, 4000K
- CRI: 83 typ. or 90+ typ.
- R9 Values: 11 (83 CRI), 55 (92 CRI)
- Binning: 3 MacAdam (SDCM)
- Life: 50,000+ hrs, > 70% of initial lumens at 50,000 hrs

Electrical

- Wattage: 9, 12, 16, 23
- Electronic constant current LED driver, 120/277VAC input
- This product complies with IEEE C62.41 for surge endurance up to 2.5KV. Amerlux® recommends using additional surge protection with this unit (supplied by others), surge and over voltage damage is not covered under warranty.**
- Note: Drivers are universal but thermal protector is voltage specific*

Drivers

- LE/TE - Leading Edge, TRIAC, forward phase/Trailing Edge, ELV, reverse phase
- 0-10V, Lutron and DALI systems available
- See pages 10-12 for more dimming information

Finish

- Powder coat paint/wet paint
- Consult factory for custom finishes

Mounting

- 26" Hanger bars included (except for Remodeler versions)
- Optional **HB49** - hanger bars from min 29" to max 49" available

Trimmed Fixture:

For use in grid or sheetrock ceilings, 5/8" - 2" max standard

Trimless Fixture:

For use in sheetrock ceilings, max ceiling thickness 5/8" (consult factory for thicker ceilings)

Millwork Fixture:

Millwork extension collars are based on ceiling material specifications and thickness. Provides flush trim appearance level with ceiling material. Ceiling thickness 1/2"-11/16". Consult factory for use in ceilings thicker than 11/16".

Not available for use with Remodeler model

Certifications

- CSA damp as tested to UL 1598 standards
- CP - Chicago Plenum (OCEA) option
- IC/AT rated (16W max)
- Damp location

Warranty

- 5 year limited warranty

Emergency Battery Pack (EM)

- Powers fixture at 5.1 watts (approx. 400 Lm) for 90 minutes (not for use with CP or IC/AT versions)

Hornet® HP Select

Round Lensed Downlight



PROJECT:

TYPE:

Product Details

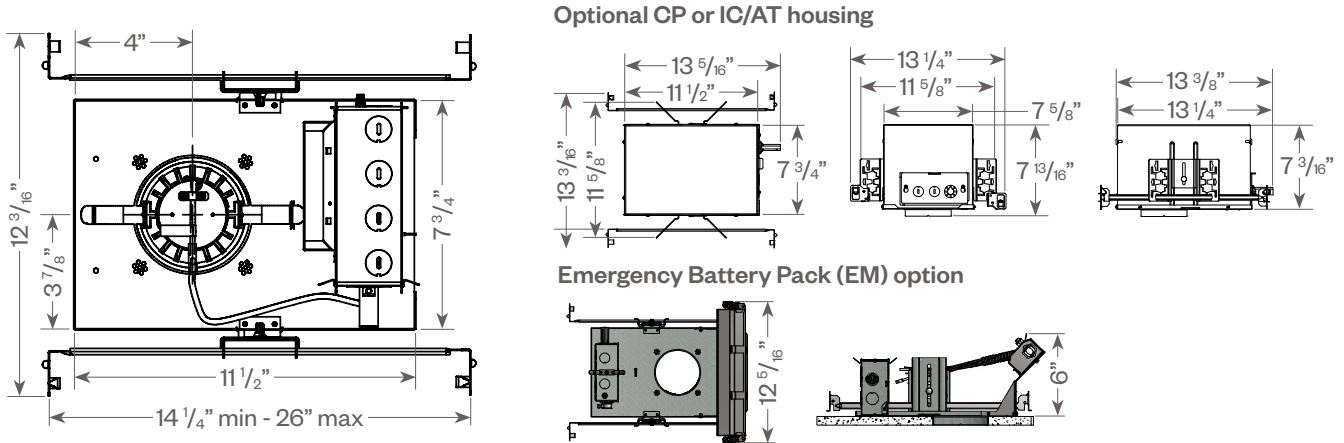

Trimmed

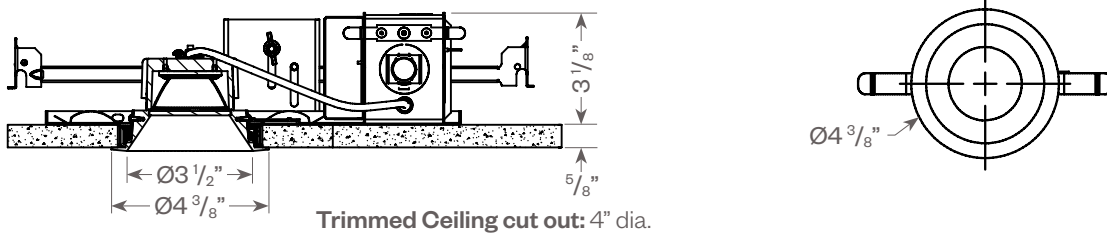

Trimless

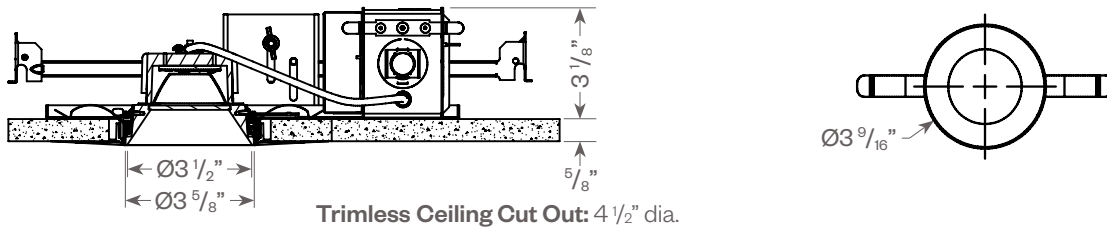

Millwork

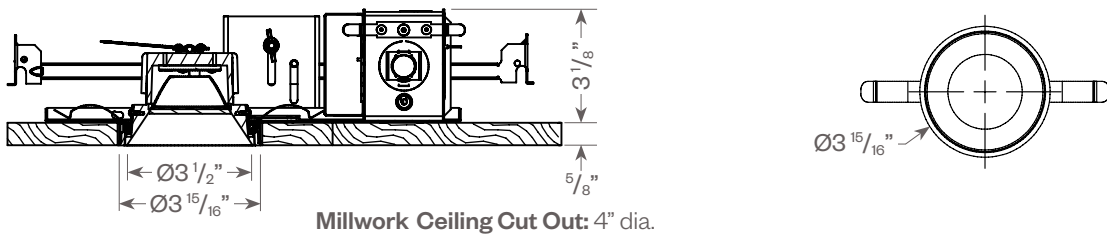

Plaster Frame Installation Detail (for trimless fixture only)

1. Ceiling 5/8"
2. 6-32 Type F Thread Cutting Screw
3. Plaster Skim Coat (by others)
4. Cast Aluminum Plaster Frame
5. Reflector Trim
6. Aperture plate

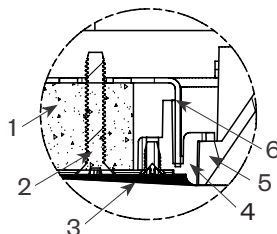

Millwork Detail

1. Reflector Trim
2. Millwork Ring
3. 1/16" required for trim to be flush with ceiling
4. Aperture Plate
5. Wood Ceiling

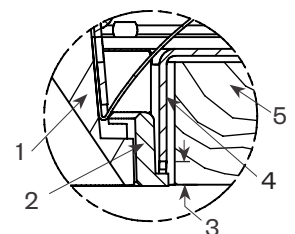

Hornet[®] HP Select

Round Lensed Downlight



PROJECT:

TYPE:

Fixture Data (complete photometric data (.ies format available upon request))

MULTIPLYING FACTORS: (Multiplying Factor is based on 3000K-83 120V IES file on website)

Wattage:	9W	12W	16W	23W
Factor:	0.39	0.52	0.69	1.0

CCT:	2700K-83	3000K-83	3500K-83	4000K-83
Factor:	0.96	1.0	1.02	1.04

CCT:	2200K-90+	2700K-90+	3000K-90+	3500K-90+	4000K-90+	CRISP	3CLA
Factor:	0.66	0.83	0.86	0.90	0.93	0.65	0.70

23W LED, 3000K-83

75° Solite Lens
LTL # 14845017.02
Lumens: 2192 lm; 100.2 lm/W

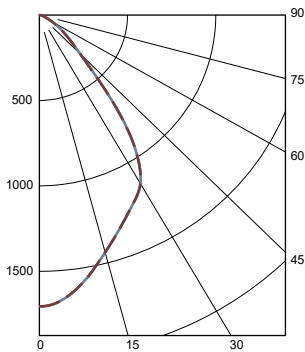

Candelas at Nadir

Deg	Candela
0	1706
5	1664
15	1437
25	1234
35	933
45	335

Application Data

75° Solite Lens

0° Aiming Angle
Horizontal
Footcandles

D	FC	L	W
5.0'	64	5.4	5.4
7.5'	30	7.9	7.9
10.0'	17	10.6	10.6
12.5'	11	13.6	13.6

Notes and Definitions:

Beam spread is to 50% center beam candlepower (CBCP).

D=Distance to floor or wall.

FC=Footcandles on floor or wall at center beam aiming location.

L=Effective Visual Beam length in feet (50% of maximum footcandle level).

W=Effective Visual Beam width in feet (50% of maximum footcandle level).

CB=Distance across or down to center beam location.

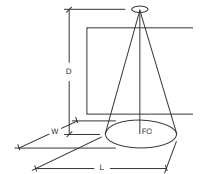

Hornet[®] HP Select

Round Lensed Downlight



PROJECT:

TYPE:

Dimming Compatibility

Amerlux[®] Hornet fixtures are compatible with all major dimming protocols prevalent in the United States. Please see below for general compatibilities and wiring diagrams. Amerlux recommends testing your unique dimming configuration as the exact full configuration (Dimmer, Fixture Quantity, Voltage, etc) may affect dimming performance.

--- NOTE: INFORMATION BELOW IS FOR WIRED DIMMERS ONLY. FOR WIRELESS DIMMERS, CONSULT FACTORY ---

TRIAC (Forward Phase) DIMMING (Standard)

Utilizes standard TRIAC dimmers that are in wide use in installations across the US. Best for retrofit applications where TRIAC dimmers are installed.

Notes:

- 120VAC or 277VAC*
- Dims down to 5% light output (most cases)
- Consult Dimming manufacturer for installation instructions - DO NOT SHARE NEUTRALS!
- Must meet dimmer Minimum Load Requirements per dimming manufacturer

TRIAC Wiring Diagram

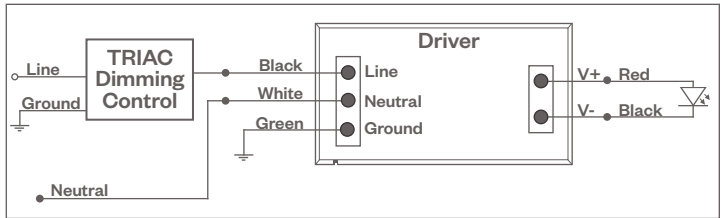

Compatible Dimmers†:

Wall Box (TRIAC 120VAC)	Central System
Lutron "Diva"	Lutron "GP" Panel
Lutron "Nova-T"	Lutron Grafik Eye QS
Lutron "Maestro"	
Lutron "Skylark"	

ELV - Electronic Low Voltage (Reverse Phase) DIMMING (Standard)

Utilizes specialized "ELV" dimmers.

Notes:

- 120VAC or 277VAC*
- Dims down to 5% light output (most cases)
- Consult Dimming manufacturer for installation instructions - DO NOT SHARE NEUTRALS!
- Must meet dimmer Minimum Load Requirements

ELV Wiring Diagram

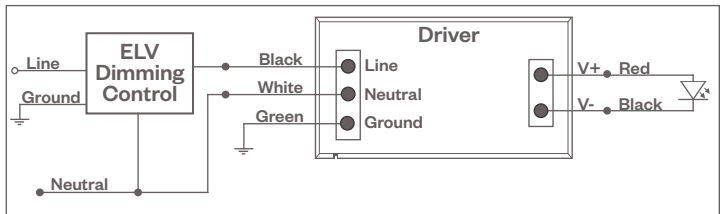

Compatible Dimmers†:

Wall Box (ELV 120VAC)	Wall Box (ELV 277VAC)	Central System
Lutron "Diva"	Leviton Revoir II AWSMT-E	Lutron "GP" Panel with PHPM-PA 120/277VAC
Lutron "Nova-T"		Lutron Grafik Eye QS with PHPM-PA 120/277VAC
Lutron "Maestro"		
Lutron "Skylark"		
Leviton "Surslide"		
Leviton "Vizio"		

Notes:

- * Driver is 277VAC dimmable with appropriate dimmer (by others). All provided wiring diagrams show 120VAC wiring colors and method. Please refer to 277VAC dimmer manufacturer installation instructions for 277VAC wiring diagrams.
- † The absence of a dimmer from the lists above does not imply incompatibility. Please consult factory for compatibility inquiries.

Hornet[®] HP Select

Round Lensed Downlight



PROJECT:

TYPE:

Dimming Compatibility

Amerlux[®] Hornet fixtures are compatible with all major dimming protocols prevalent in the United States. Please see below for general compatibilities and wiring diagrams. Amerlux recommends testing your unique dimming configuration as the exact full configuration (Dimmer, Fixture Quantity, Voltage, etc) may affect dimming performance.

--- NOTE: INFORMATION BELOW IS FOR WIRED DIMMERS ONLY. FOR WIRELESS DIMMERS, CONSULT FACTORY ---

0-10V DIMMING

Integrates into a variety of building management and daylighting controls

Notes:

- 120VAC or 277VAC*
- Dims down to 1% light output
- Requires interface to turn off power to driver
- Consult Dimming manufacturer for installation instructions - DO NOT SHARE NEUTRALS!

0-10V Wiring Diagram

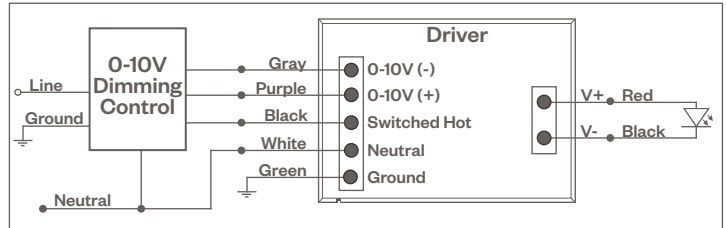

Compatible Dimmers*:

Wall Box

Lutron "Diva" - DVSTV | Leviton Renoir II 0-10V

Central System

Lutron Grafik Eye with GRX-TVI Interface

LUTRON LDE1 DIMMING

Integrates into Lutron EcoSystem building management

Notes:

- 120VAC or 277VAC*
- Dims down to 1% Soft-On/Fade-to-Black
- EcoSystem Control
- Consult Dimming manufacturer for installation instructions - DO NOT SHARE NEUTRALS!

Lutron LDE1 (HILUME-H-ECO)

EcoSystem Digital Control Wiring Diagram

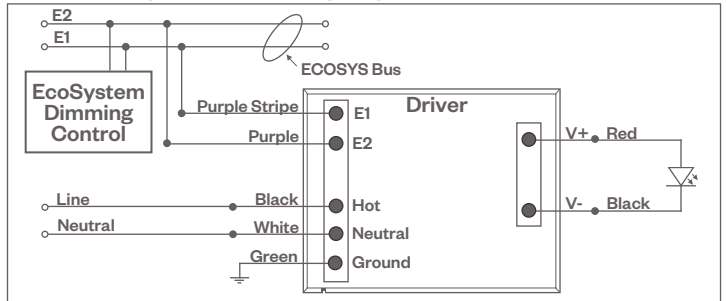

Compatible Dimmers*:

Lutron ECO System

Pow Pak Dimming Modules
Energj Savr Node
Grafik Eye QS/Homeworks
QS Control Unit
Quantum Hub
Homeworks QS/My Room

Central System

Lutron EcoSystem compatible controls

DALI DIMMING

Digital control protocol allows individual fixture control

Notes:

- 120VAC - 277VAC*
- Dims down to 1% light output in most cases

DALI Wiring Diagram

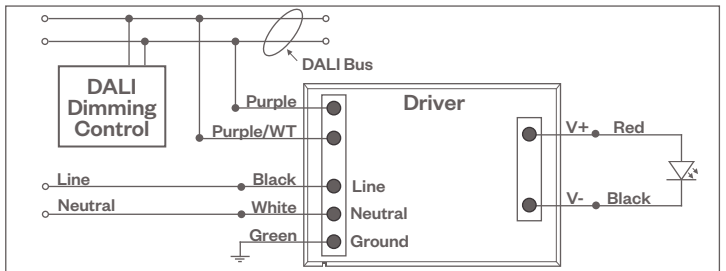

Compatible Dimmers*:

Wall Box (3-Wire Fluorescent)

Leviton CD250 Controller

Central System

Dynalite
Fifth Light

Notes:

- * Driver is 277VAC dimmable with appropriate dimmer (by others). All provided wiring diagrams show 120VAC wiring colors and method. Please refer to 277VAC dimmer manufacturer installation instructions for 277VAC wiring diagrams.
- † The absence of a dimmer from the lists above does not imply incompatibility. Please consult factory for compatibility inquiries.

Hornet[®] HP Select

Round Lensed Downlight



PROJECT:

TYPE:

Emergency Battery Pack

Wiring Diagram

