

# Essenza®

## Square Downlights

### Dim-To-Warm

### Features

Add ambiance to any hospitality, residential, retail or commercial space. Amerlux Essenza Downlight Dim-To-Warm option offers a lower kelvin temperature as you dim the lights. An adaptable light source in a cost-effective, solid state lighting package. The Dim-To-Warm option can tap into the powerful mediums of light and color to enhance the experience, well-being, and human emotion. Amerlux Dim-To-Warm allows designers to simulate the familiar glow and dimming of incandescent lamps.

### Product Overview

- Type: Recessed Square Downlight, Accent, Wall Wash
- Wattage: 12W (IC/AT), 15W
- Lumen Output: 866 lm max (EZSD trim, 15W, Spot optic)
- Color Temp: 3000K to 1800K
- CRI: 95 typ.
- Dimming: TRIAC & ELV (120/277VAC) - 5% Dim  
Lutron LDE1 Hi-lume® 1% Soft-On/Fade-to-Black (120/277VAC)  
0-10V (120/277VAC) - 1% Dim  
DALI dimming - 1% Dim



Downlight



Adjustable

### PROJECT:

### TYPE:



Lens Wall Wash



Shower



Pinhole Downlight

### Fixture Type

New Construction	Remodeler	Trim	Trimless
Yes	Yes	Yes	Yes

### Electrical Data

	12W (IC/AT)		15W*	
	System Watts	Amps	System Watts	Amps
120V	12	0.10	15	0.13
277V	12	0.04	16	0.06

Electronic constant current LED driver  
\*Includes 2W thermal protector

### Dim-To-Warm CCT Curve

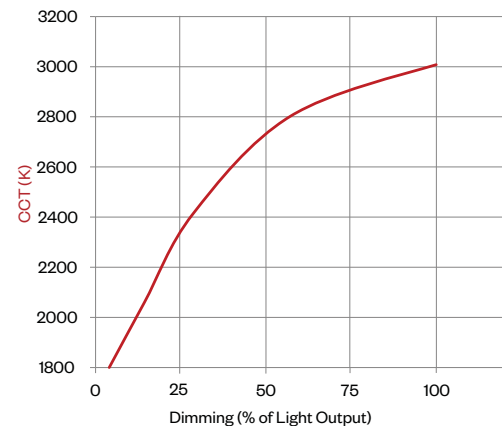

**PROJECT:**

**TYPE:**

**Housing/Frame Ordering Information**

1	2	3	4	5	6
<p><b>1 Model</b> For New Construction <b>EZ-NC-DTW-A17†</b> (New Construction) <b>EZ-CP-DTW-A17†</b> (Chicago Plenum (CCEA) housing) <b>EZ-IC-DTW-A17†</b> (Insulated Ceiling/air tight housing, 12W only)</p> <p>For Existing Ceilings <b>EZ-REM-DTW-A17†</b></p>	<p><b>2 Style</b> T - trimmed STL - square trimless</p>	<p><b>3 Wattage</b> 12 (IC/AT) 15 (not available for use with IC housing)</p>	<p><b>4 Voltage</b> 120 277 120/277 (for use with IC housing only)</p>	<p><b>5 Driver</b> LE/TE - TRIAC/ELV dimming HILUME-H-ECO - Lutron LDE1 Hi-lume® 1% Soft-On/ Fade-to-Black 0-10V - 0-10V dimming, 1% dim DALI - DALI dimming, 1% dim</p>	<p><b>6 Options/Accessories</b> EM - integral emergency battery pack with remote test switch, requires 7" ceiling clearance (not available for use with REM, CP or IC option) HB49 - hanger bars from min 29" to max 49" (not available for use with REM options)</p>

**Trim Ordering Information**

1	2	3	4	5
<p><b>1 Model</b> <b>EZSD-DTW-A17†</b> (downlight) <b>EZSA-DTW-A17†</b> (adjustable) <b>EZSLW-DTW-A17†</b> (wall wash) <b>EZSSHW-DTW-A17†</b> (shower, not available for use in trimless) <b>EZSPD-DTW-A17†</b> (pinhole downlight)</p>	<p><b>2 Style</b> T - trimmed TL - trimless (not available for Shower (EZSSHW) trim)</p>	<p><b>3 Finish</b> SD/SA/SLW/SSHW Trims: Trimmed Trimless <b>MWW</b> - matte white, white flange <b>MW</b> - matte white</p> <p>SPD Trim (Trimmed &amp; Trimless): <b>MW</b> - matte white</p>	<p><b>4 Beam Spreads</b> (not for use with EZSLW trim) VNF - very narrow flood, 18° FL - flood, 35° WF* - wide flood, 45° VWF* - very wide flood, 50° * Not available for use with EZRPD trim</p>	<p><b>5 Color Temp</b> 95 CRI 309 - 3000K-95</p>

† The "A" refers to the sequential revision in a year and "XX" refers to the year of update. Updates coincide with improved performance while not changing the overall fixture aesthetic and are reflected in the published performance data. Please contact your Amerlux representative for explanations of changes.

## PROJECT:

## TYPE:

### Specifications

#### Application

Hospitality, retail and commercial ambient, accent and wall wash lighting

#### Construction

20 ga. galvanized steel frame  
18 ga. galvanized steel splice housing and hanger brackets (not for use with Remodeler version)  
Cast aluminum plaster frame with perforated face (for trimless version only)  
Die-cast optical housing, trim and heatsink

#### Optical

Beam spreads (for SD, SA, SSHW & SPD fixtures):

Very Narrow Flood, 18°; Flood, 35°; Wide Flood, 45°;  
Very Wide Flood, 50°

Tilt (for SA fixture): 0-30° tilt lock, 355° rotation

Lens:

SLW fixture: Engineered nano technology lens provides high transmission while concealing LED image

Shower fixture: Siliconed solite lens

#### LED

Color Temp Options:

3000K dims to 1800K (12W fixtures start at 2900K)

CRI: 95 typ. ( $\pm 3$  across dimming range)

R9 Values: 85 (95 CRI)

Binning: 3 MacAdam (SDCM)

Life: 50,000+ hrs, > 70% of initial lumens at 50,000 hrs

#### Electrical

Wattage: 12 (IC/AT), 15

Electronic constant current LED driver, 120/277VAC input

**This product complies with IEEE C62.41 for surge endurance up to 2.5KV. Amerlux® recommends using additional surge protection with this unit (supplied by others), surge and over voltage damage is not covered under warranty.**

**Note:** Drivers are universal input voltage but thermal protector is voltage specific

#### Drivers

LE/TE - Leading Edge, TRIAC, forward phase/Trailing Edge, ELV, reverse phase

0-10V, Lutron and DALI systems also available

See pages 12-13 for more dimming information

#### Finish

Powder coat paint

Consult factory for custom finishes

#### Mounting

26" Hanger bars included (except for Remodeler versions)

Optional **HB49** - hanger bars from min 29" to max 49" available

Trimmed

For use in T-grid or sheetrock ceilings, max thickness 1"

Trimless

For use in sheetrock ceilings, max thickness 5/8"

#### Certifications

OSA listed to UL standards

Damp location

IC/AT (insulated ceiling/air tight) rated, 12W only, optional

Chicago Plenum (CCEA) optional

JA10 compliant for Title 24 per UL Test 13005791.01A

(available upon request)

#### Warranty

3 year limited warranty

**PROJECT:**

**TYPE:**

**Essenza Square Downlight:**

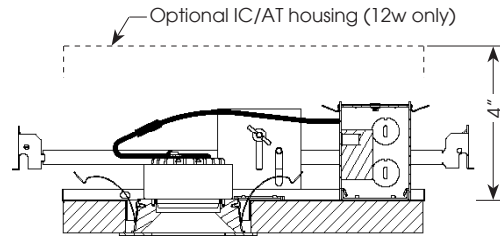
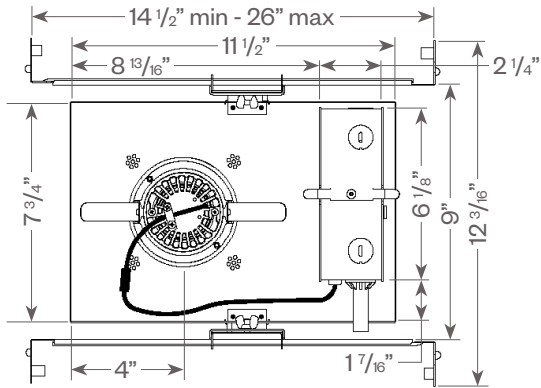

Ceiling cut out: 4" dia.

**Downlight**

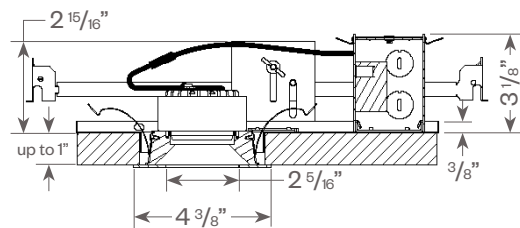

**Adjustable**

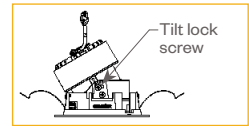
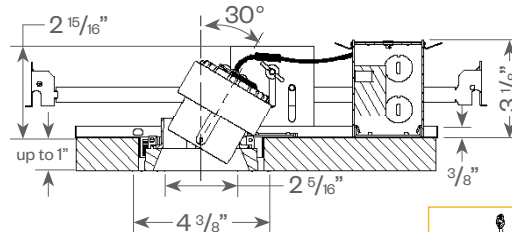

**Lens Wall Wash**

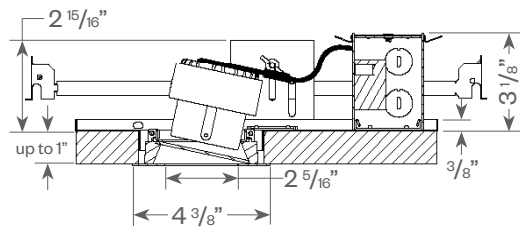

**Shower**

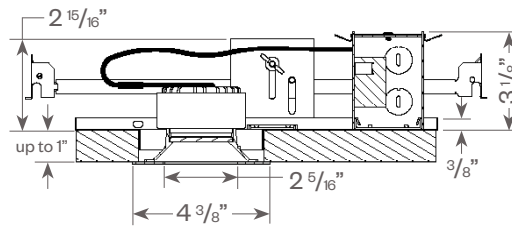

**Pinhole Downlight**

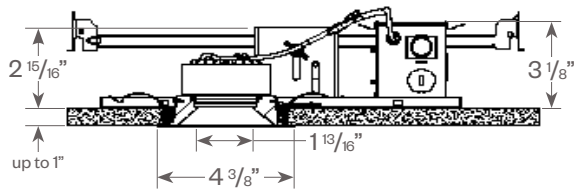

**Frame with Emergency Battery Pack**

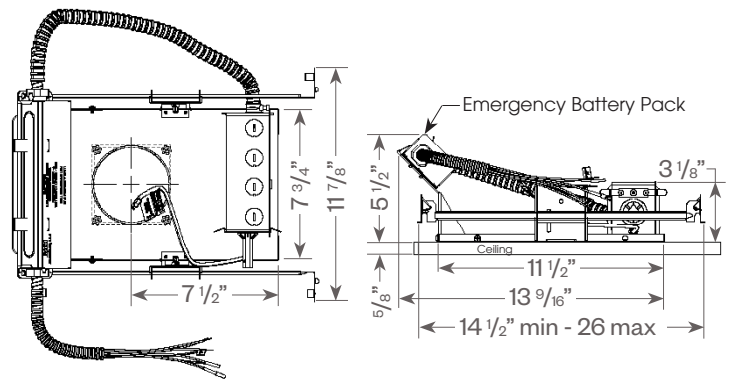

**PROJECT:**

**TYPE:**

**Essenza Square Downlight Trimless:**

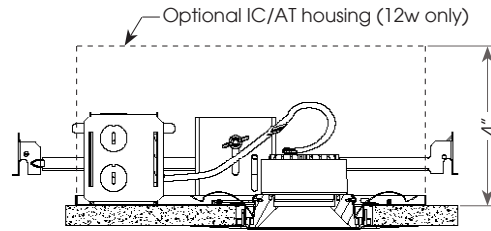
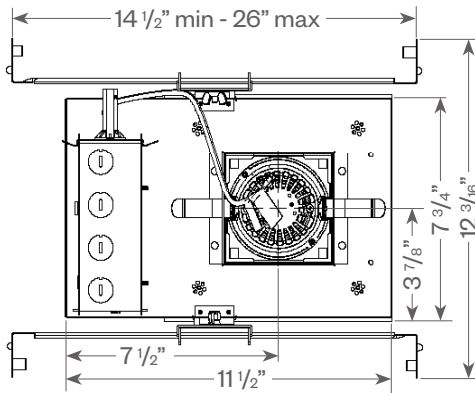

Trimless Ceiling cut out: 4 1/2" sq.

**Downlight**

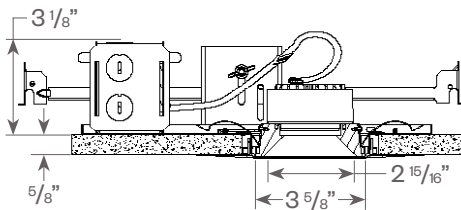

**Adjustable**

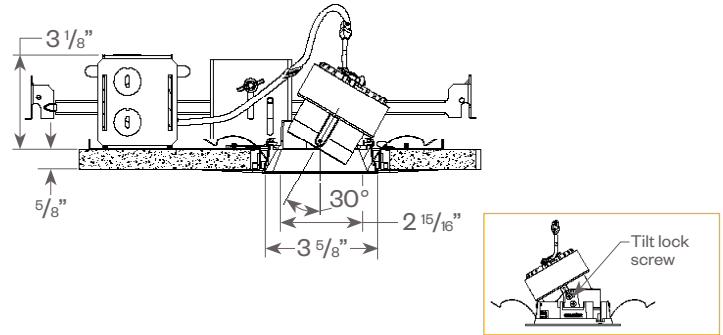

**Lens Wall Wash**

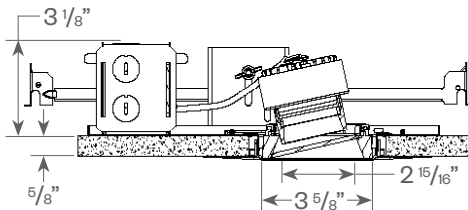

**Pinhole Downlight**

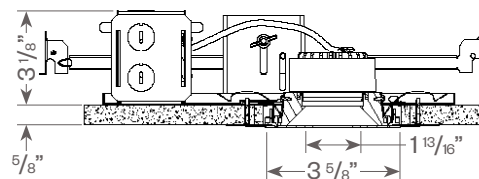

**Plaster Frame Installation Detail**  
(for trimless fixture only)

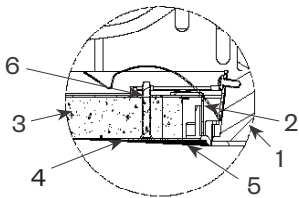

1. Reflector Trim
2. Aperture plate
3. Ceiling 5/8"
4. Cast Aluminum Plaster Frame
5. Plaster Skim Coat (by others)
6. 6-32 Type F Thread Cutting Screw

**Frame with Emergency Battery Pack**

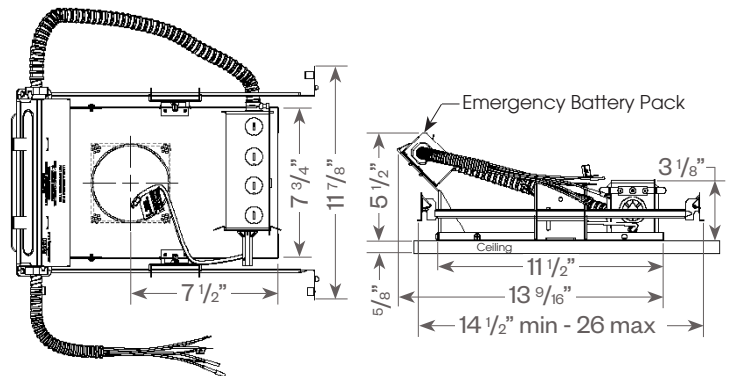

**PROJECT:**

**TYPE:**

**Essenza Square Remodeler:**

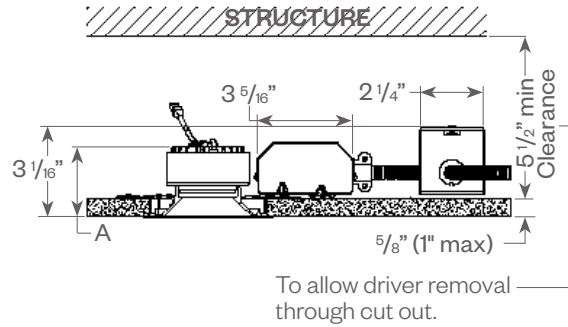
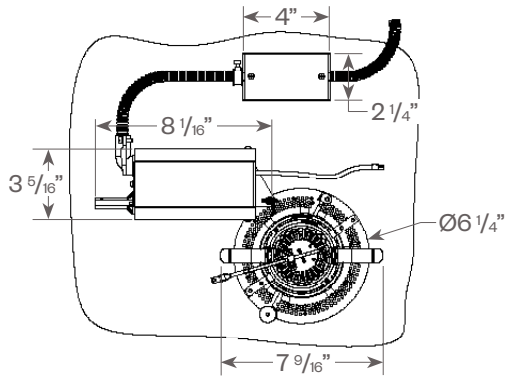

Product	A
EZ-SD-REM	2 3/8"
EZ-SA-REM	3 3/16"
EZ-SLW-REM	3 5/16"
EZ-SSHW-REM	2 3/8"
EZ-SPD-REM	2 3/8"

Ceiling cut out: 4" dia.

**Downlight**

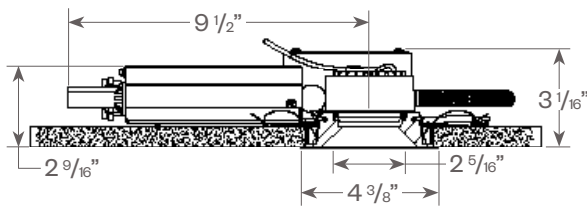

**Adjustable**

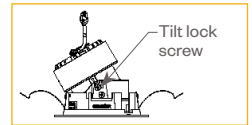
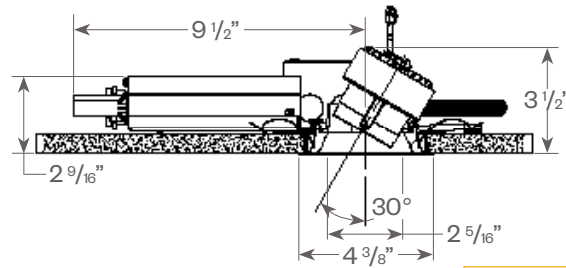

**Lens Wall Wash**

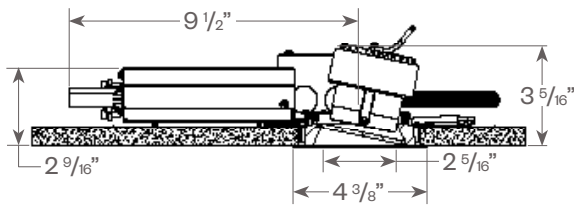

**Shower**

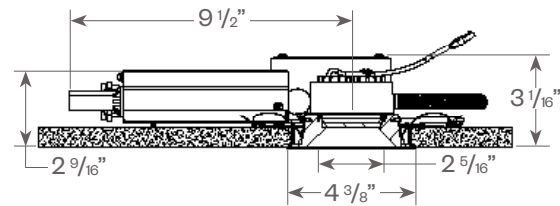

**Pinhole Downlight**

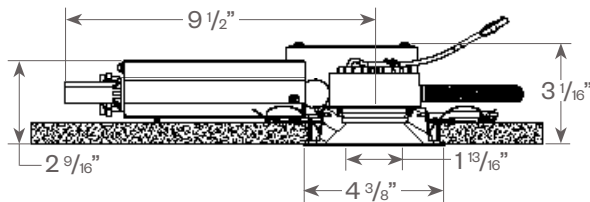

**PROJECT:**

**TYPE:**

**Essenza Square Remodeler Trimless:**

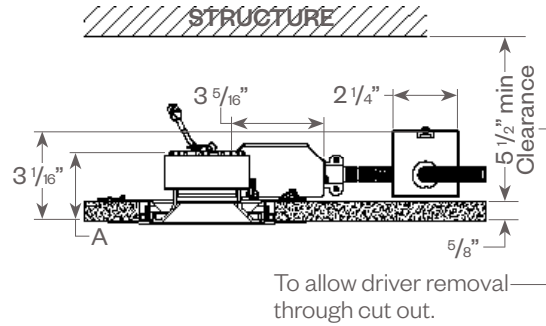
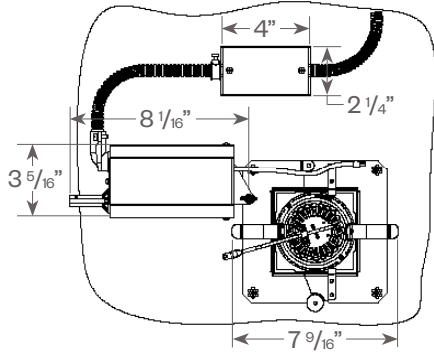

Product	A
EZ-SD-REM-TL	2 5/16"
EZ-SA-REM-TL	3 3/16"
EZ-SLW-REM-TL	3 1/4"
EZ-SPD-REM-TL	2 5/16"

Trimless Ceiling cut out: 4 1/2" sq.

**Downlight**

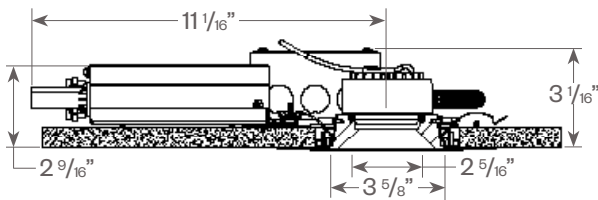

**Adjustable**

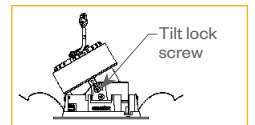
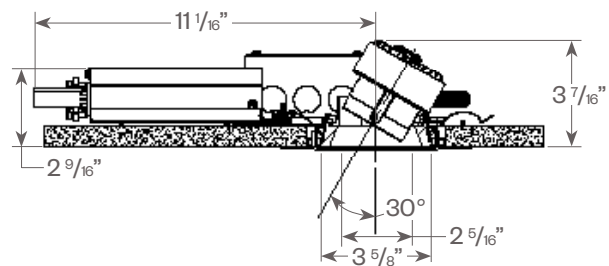

**Lens Wall Wash**

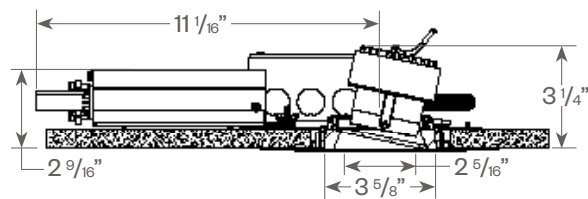

**Pinhole Downlight**

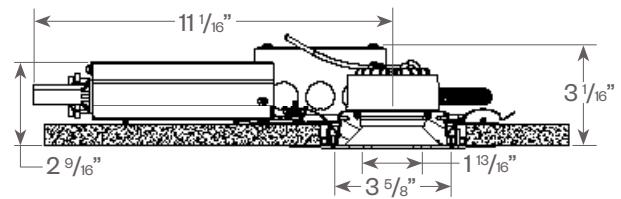

**Plaster Frame Installation Detail** (for trimless fixture only)

1. Reflector Trim
2. Aperture plate
3. Ceiling 5/8"
4. Cast Aluminum Plaster Frame
5. Plaster Skim Coat (by others)
6. 6-32 Type F Thread Cutting Screw

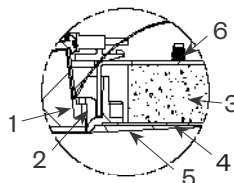

**PROJECT:**

**TYPE:**

**Essenza Square Downlight:**

**FIXTURE DATA:** (Complete photometric data (.ies format) available upon request)

**MULTIPLYING FACTORS:** (Multiplying Factor is based on 3000K-95 120V IES file on website)

<b>Wattage:</b>	<b>12W</b>	<b>15W</b>
Factor:	0.8	1.0

**15W LED, 3000K-95**

**Very Narrow Flood (VNF)**  
Distribution, 18°  
LTL # 11919582.01  
Lumens: 866

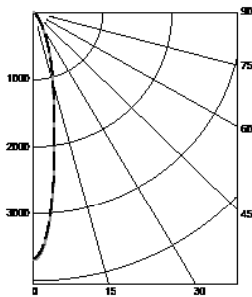

**Candelas at Nadir**

Deg	Candela
0	3674
5	2877
15	1011
25	392
35	143
45	40

**Flood (FL)**  
Distribution, 35°  
LTL# 11919582.02  
Lumens: 796

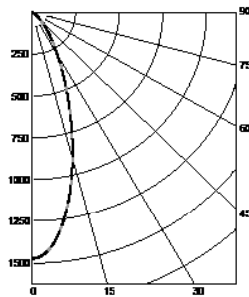

**Candelas at Nadir**

Deg	Candela
0	1474
5	1392
15	900
25	434
35	192
45	72

**Wide Flood (WF)**  
Distribution, 45°  
LTL # 11919582.03  
Lumens: 790

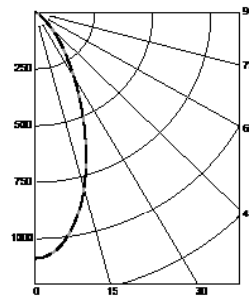

**Candelas at Nadir**

Deg	Candela
0	1086
5	1051
15	799
25	459
35	223
45	92

**Very Wide Flood (VWF)**  
Distribution, 50°  
LTL # 11919582.04  
Lumens: 663

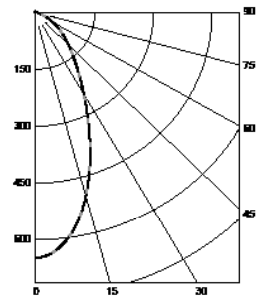

**Candelas at Nadir**

Deg	Candela
0	648
5	629
15	497
25	317
35	189
45	118

**Application Data:**

**0° Aiming Angle Horizontal Footcandles**



	D	FC	L	W
<b>Very Narrow Flood</b>	5.0'	141	1.6	1.6
	7.5'	64	2.5	2.5
	10.0'	36	3.3	3.3
	12.5'	23	3.9	3.9
<b>Flood</b>	5.0'	57	3.1	3.1
	7.5'	26	4.5	4.5
	10.0'	15	5.9	5.9
	12.5'	9	7.5	7.5
<b>Wide Flood</b>	5.0'	42	3.6	3.6
	7.5'	19	5.4	5.4
	10.0'	11	7.2	7.2
	12.5'	7	9.0	9.0
<b>Very Wide Flood</b>	5.0'	25	3.8	3.8
	7.5'	11	5.7	5.7
	10.0'	7	7.7	7.7
	12.5'	4	9.7	9.7

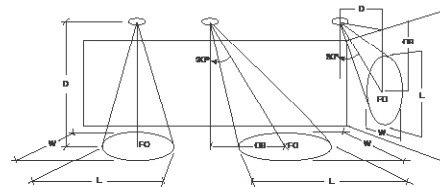

**Notes and Definitions:**

- Beam spread is to 50% center beam candlepower (CBCP).
- D**=Distance to floor or wall.
- FC**=Footcandles on floor or wall at center beam aiming location.
- L**=Effective Visual Beam length in feet (50% of maximum footcandle level).
- W**=Effective Visual Beam width in feet (50% of maximum footcandle level).
- CB**=Distance across or down to center beam location.



**PROJECT:**

**TYPE:**

**Essenza Square Adjustable:**

**FIXTURE DATA:** (Complete photometric data (.ies format) available upon request)

**MULTIPLYING FACTORS:** (Multiplying Factor is based on 3000K-95 120V IES file on website)

Wattage:	12W	15W
Factor:	0.8	1.0

**15W LED, 3000K-95**

**Very Narrow Flood (VNF)**  
Distribution, 18°  
LTL # 11919582.05  
Lumens: 780

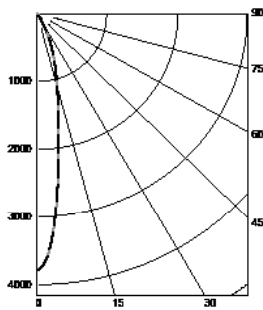

**Candelas at Nadir**

Deg	Candela
0	3781
5	2933
15	1042
25	335
35	61
45	33

**Flood (FL)**  
Distribution, 35°  
LTL# 11919582.06  
Lumens: 699

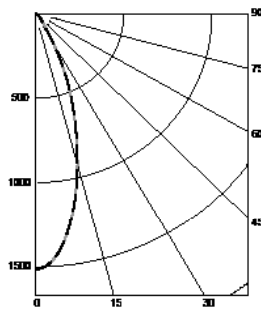

**Candelas at Nadir**

Deg	Candela
0	1515
5	1430
15	919
25	405
35	91
45	41

**Wide Flood (WF)**  
Distribution, 45°  
LTL # 11919582.07  
Lumens: 679

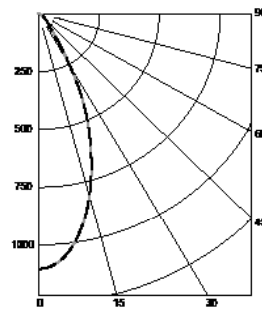

**Candelas at Nadir**

Deg	Candela
0	1103
5	1067
15	809
25	445
35	117
45	46

**Application Data:**

**0° Aiming Angle Horizontal Footcandles**



	0° Aiming Angle Horizontal Footcandles			
	D	FC	L	W
Very Narrow Flood	5.0'	145	1.6	1.6
	7.5'	66	2.5	2.5
	10.0'	37	3.3	3.3
	12.5'	24	3.9	3.9
Flood	5.0'	58	3.1	3.1
	7.5'	26	4.5	4.5
	10.0'	15	5.9	5.9
	12.5'	10	7.4	7.4
Wide Flood	5.0'	43	3.6	3.6
	7.5'	19	5.4	5.4
	10.0'	11	7.1	7.1
	12.5'	7	8.9	8.9

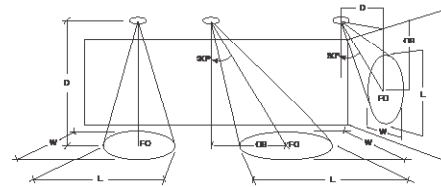

**Notes and Definitions:**

Beam spread is to 50% center beam candlepower (CBCP).

**D**=Distance to floor or wall.

**FC**=Footcandles on floor or wall at center beam aiming location.

**L**=Effective Visual Beam length in feet (50% of maximum footcandle level).

**W**=Effective Visual Beam width in feet (50% of maximum footcandle level).

**CB**=Distance across or down to center beam location.

**PROJECT:**

**TYPE:**

**Essenza Square Lens Wall Wash:**

**FIXTURE DATA:** (Complete photometric data (.ies format) available upon request)

**MULTIPLYING FACTORS:** (Multiplying Factor is based on 3000K-95 120V IES file on website)

Wattage:	12W	15W
Factor:	0.8	1.0

**15W LED, 3000K-95**

**Lens Wall Wash (RLW) Distribution**

LTL #11919582.11

Lumens: 533

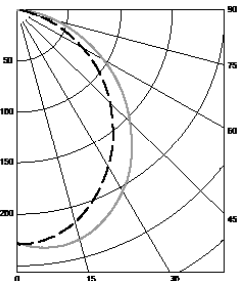

**ZONAL LUMEN SUMMARY**

Zone	Lumens	%Fixt
0-40	270	50.7
0-60	449	84.1
0-90	533	100.0
90-180	0	0.0

**Luminaire Efficacy: 36.3 lumens/watt**

**Application Data:**

Footcandles are average and rounded off.  
Data for multiple units are based on a minimum of five units.

**Footcandles on Wall**

1.5 Feet From Wall

Distance from ceiling	1.5' Spacing					
	0.5'	1.5'	2.5'	3.5'	4.5'	5.5'
0.5'	29	30	32	30	29	
1.5'	45	47	49	47	45	
2.5'	28	31	32	31	29	
3.5'	17	19	19	19	17	
4.5'	11	12	12	12	11	
5.5'	7	8	8	8	8	
6.5'	5	6	6	6	6	
7.5'	4	5	5	5	4	

1.5 Feet From Wall

Distance from ceiling	2' Spacing					
	0.5'	1.5'	2.5'	3.5'	4.5'	5.5'
0.5'	20	27	21	27	21	20
1.5'	34	38	36	38	36	34
2.5'	23	24	25	25	24	23
3.5'	14	15	16	16	15	14
4.5'	9	10	10	10	10	9
5.5'	6	7	7	7	7	6
6.5'	5	5	5	5	5	5
7.5'	4	4	4	4	4	4

2 Feet From Wall

Distance from ceiling	2' Spacing					
	0.5'	1.5'	2.5'	3.5'	4.5'	5.5'
0.5'	12	13	13	13	13	12
1.5'	24	26	26	26	26	24
2.5'	22	23	24	24	24	22
3.5'	15	17	17	18	17	15
4.5'	11	12	12	12	12	11
5.5'	8	8	9	9	9	8
6.5'	6	6	6	7	6	6
7.5'	5	5	5	5	5	5

**PROJECT:**

**TYPE:**

**Essenza Square Shower:**

**FIXTURE DATA:** (Complete photometric data (.ies format) available upon request)

**15W LED, 3000K-95**

**Very Narrow Flood (VNF)**  
Distribution, 18°  
LTL # 11919582.08  
Lumens: 813

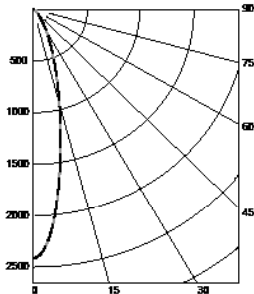

Candelas at Nadir

Deg	Candela
0	2413
5	2103
15	961
25	389
35	155
45	56

**Flood (FL)**  
Distribution, 35°  
LTL# 11919582.09  
Lumens: 748

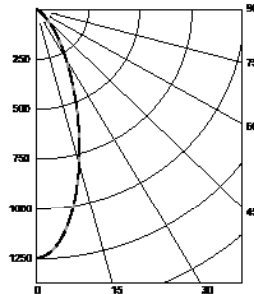

Candelas at Nadir

Deg	Candela
0	1246
5	1181
15	796
25	412
35	194
45	79

**Wide Flood (WF)**  
Distribution, 45°  
LTL # 11919582.10  
Lumens: 742

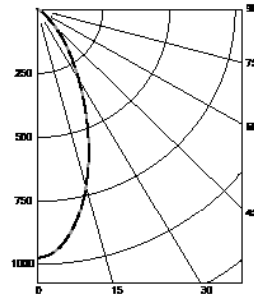

Candelas at Nadir

Deg	Candela
0	974
5	940
15	713
25	427
35	219
45	94

**Application Data:**

		0° Aiming Angle Horizontal Footcandles			
		D	FC	L	W
Very Narrow Flood	5.0'	93	2.2	2.2	
	7.5'	42	3.3	3.3	
	10.0'	24	4.2	4.2	
	12.5'	15	5.3	5.3	
Flood	5.0'	48	3.2	3.2	
	7.5'	22	4.7	4.7	
	10.0'	12	6.2	6.2	
	12.5'	8	7.8	7.8	
Wide Flood	5.0'	38	3.6	3.6	
	7.5'	17	5.4	5.4	
	10.0'	10	7.2	7.2	
	12.5'	6	9.1	9.1	

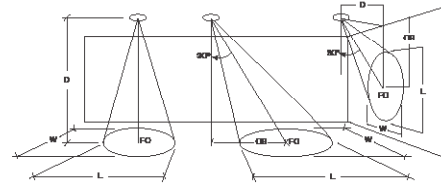

**Notes and Definitions:**

Beam spread is to 50% center beam candlepower (CBCP).

**D**=Distance to floor or wall.

**FC**=Footcandles on floor or wall at center beam aiming location.

**L**=Effective Visual Beam length in feet (50% of maximum footcandle level).

**W**=Effective Visual Beam width in feet (50% of maximum footcandle level).

**CB**=Distance across or down to center beam location.

**PROJECT:**

**TYPE:**

**DIMMING COMPATIBILITY:**

Amerlux® Essenza fixtures are compatible with all major dimming protocols prevalent in the United States. Please see below for general compatibilities and wiring diagrams. Amerlux recommends testing your unique dimming configuration as the exact full configuration (Dimmer, Fixture Quantity, Voltage, etc) may affect dimming performance.

**--- NOTE: INFORMATION BELOW IS FOR WIRED DIMMERS ONLY. FOR WIRELESS DIMMERS, CONSULT FACTORY ---**

**TRIAC (Forward Phase) DIMMING (Standard)**

Utilizes standard TRIAC dimmers that are in wide use in installations across the US. Best for retrofit applications where TRIAC dimmers are installed.

**Notes:**

- 120VAC or 277VAC\*
- Dims down to 5% light output (most cases)
- Consult Dimming manufacturer for installation instructions - DO NOT SHARE NEUTRALS!
- Must meet dimmer Minimum Load Requirements per dimming manufacturer

**TRIAC Wiring Diagram**

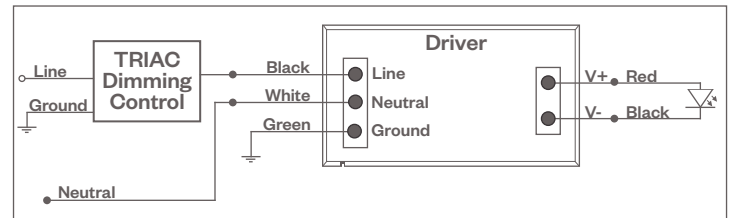

**Compatible Dimmers\*:**

Wall Box (TRIAC 120VAC)	Central System
Lutron "Diva"	Lutron "GP" Panel
Lutron "Nova-T"	Lutron Grafik Eye QS
Lutron "Maestro"	
Lutron "Skylark"	

**ELV - Electronic Low Voltage (Reverse Phase) DIMMING (Standard)**

Utilizes specialized "ELV" dimmers.

**Notes:**

- 120VAC or 277VAC\*
- Dims down to 5% light output (most cases)
- Consult Dimming manufacturer for installation instructions - DO NOT SHARE NEUTRALS!
- Must meet dimmer Minimum Load Requirements

**ELV Wiring Diagram**

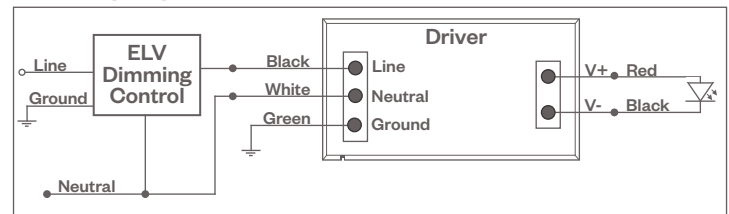

**Compatible Dimmers\*:**

Wall Box (ELV 120VAC)	Wall Box (ELV 277VAC)	Central System
Lutron "Diva"	Leviton Revoir II AWSMT-E	Lutron "GP" Panel with PHPM-PA 120/277VAC
Lutron "Nova-T"		Lutron Grafik Eye QS with PHPM-PA 120/277VAC
Lutron "Maestro"		
Lutron "Skylark"		
Leviton "Surslide"		
Leviton "Vizio"		

**Notes:**

- \* Driver is 277VAC dimmable with appropriate dimmer (by others). All provided wiring diagrams show 120VAC wiring colors and method. Please refer to 277VAC dimmer manufacturer installation instructions for 277VAC wiring diagrams.
- † The absence of a dimmer from the lists above does not imply incompatibility. Please consult factory for compatibility inquiries.

**PROJECT:**

**TYPE:**

**DIMMING COMPATIBILITY:**

Amerlux® Essenza fixtures are compatible with all major dimming protocols prevalent in the United States. Please see below for general compatibilities and wiring diagrams. Amerlux recommends testing your unique dimming configuration as the exact full configuration (Dimmer, Fixture Quantity, Voltage, etc) may affect dimming performance.

**--- NOTE: INFORMATION BELOW IS FOR WIRED DIMMERS ONLY. FOR WIRELESS DIMMERS, CONSULT FACTORY ---**

**0-10V DIMMING**

Integrates into a variety of building management and daylighting controls

**Notes:**

- 120VAC or 277VAC\*
- Dims down to 1% light output
- Requires interface to turn off power to driver
- Consult Dimming manufacturer for installation instructions - DO NOT SHARE NEUTRALS!

**0-10V Wiring Diagram**

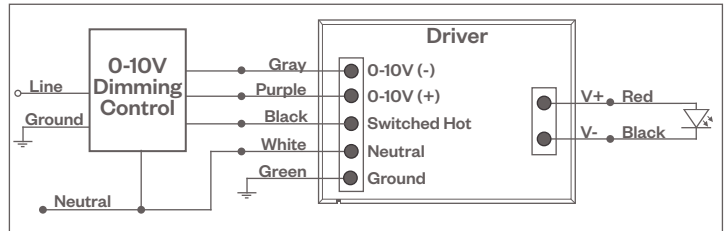

**Compatible Dimmers\*:**

**Wall Box**

Lutron "Diva" - DVSTV | Leviton Renoir II 0-10V

**Central System**

Lutron Grafik Eye with GRX-TV1 Interface

**LUTRON LDE1 DIMMING**

Integrates into Lutron EcoSystem building management

**Notes:**

- 120VAC or 277VAC\*
- Dims down to 1% Soft-On/Fade-to-Black
- EcoSystem Control
- Consult Dimming manufacturer for installation instructions - DO NOT SHARE NEUTRALS!

**Lutron LDE1 (HILUME-H-ECO)**

**EcoSystem Digital Control Wiring Diagram**

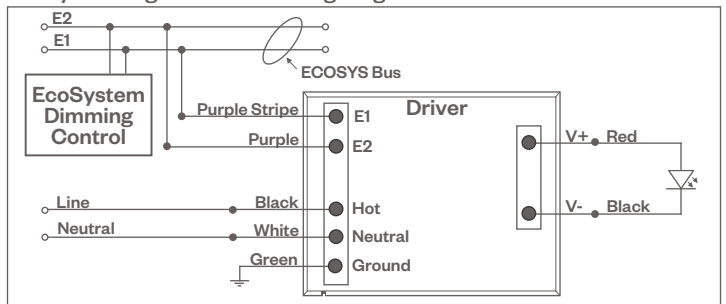

**Compatible Dimmers\*:**

**Lutron ECO System**

Pow Pak Dimming Modules  
Energj Savr Node  
Grafik Eye QS/Homeworks  
QS Control Unit  
Quantum Hub  
Homeworks QS/My Room

**Central System**

Lutron EcoSystem compatible controls

**DALI DIMMING**

Digital control protocol allows individual fixture control

**Notes:**

- 120VAC - 277VAC\*
- Dims down to 1% light output in most cases

**DALI Wiring Diagram**

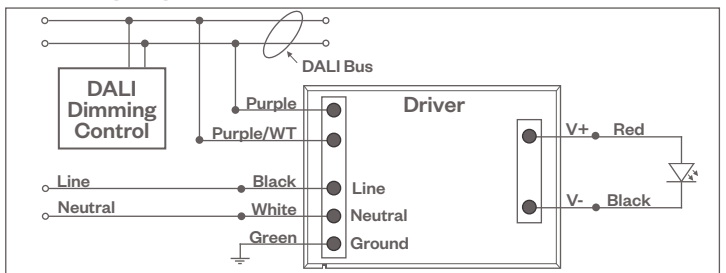

**Compatible Dimmers\*:**

**Wall Box (3-Wire Fluorescent)**

Leviton CD250 Controller

**Central System**

Dynalite  
Fifth Light

**Notes:**

- \* Driver is 277VAC dimmable with appropriate dimmer (by others). All provided wiring diagrams show 120VAC wiring colors and method. Please refer to 277VAC dimmer manufacturer installation instructions for 277VAC wiring diagrams.
- † The absence of a dimmer from the lists above does not imply incompatibility. Please consult factory for compatibility inquiries.