

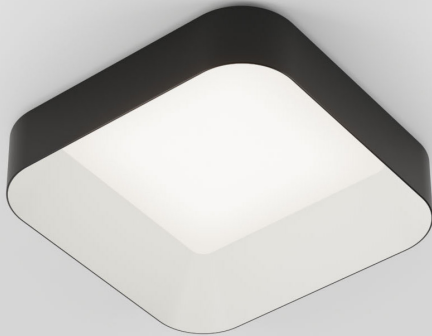

Stadia 8" Downlight



Stadia 8"



Features

Stadia is a collection of architectural decorative downlights that offers designers a new way to add visual interest in a space while providing soft, uniform ambient lighting. Stadia downlights have a soft square trim extending 2" below the ceiling that is offered in a variety of standard and premium finishes including neutrals, hues, metallic and wood grain finishes. The trim is offered in 2 sizes: 5" and 8" and is offered both with a single-tone finish, where the outer trim and inner bevel have the same finish, or a two-tone finish, where the outer trim and inner bevel have different finishes.

Product Overview

- Fixture Type: Architectural Decorative Downlight
- Wattage: 9, 12, 18, 23, 34
- Color Temp: 2700K, 3000K, 3500K, 4000K
- CRI: 90+ typ.
- Dimming: 0-10V 1% Dim (120/277VAC)
 TRIAC & ELV 5% Dim (120/277VAC)
 DALI 1% Dim (120/277VAC)
 Lutron LDE1 Hi-lume® 1% Dim Soft-On/Fade-to-Black (120/277VAC)

PROJECT:

TYPE:

Product Overview

Watts	Delivered Lumens	LPW	Color Temp, CRI
9	850	94.4	3500K, 90+
12	1200	100.0	3500K, 90+
18	1700	94.4	3500K, 90+
23	2200	95.7	3500K, 90+
34	3102	91.2	3500K, 90+

Stadia allows designers to mix different sizes and finishes to add visual interest to the ceiling. When used in a cluster, the below table shows visually similar lumen packages for the 5" and 8":

5"	8"
325 lm	850 lm
700 lm	1700 lm
1250 lm	3102 lm

See separate spec sheet for Stadia 8"

Electrical Data

	9W		12W		18W	
	System Watts	Amps	System Watts	Amps	System Watts	Amps
120V	8.5	0.07	12.1	0.10	17.3	0.14
277V	9.3	0.03	12.4	0.05	17.4	0.06
	23W		34W			
	System Watts	Amps	System Watts	Amps		
120V	22.9	0.19	34.07	0.28		
277V	22.9	0.08	33.8	0.12		

Electronic constant current LED driver



PROJECT:

TYPE:

Housing/Frame Ordering Information

1	2	3	4	5	6
1 Model	2 Style			3 Wattage	
STADIA-88-NC New Construction Housing for 8" Stadia	SST soft square trim (semi-recessed)			9 12 18 23 34	
4 Voltage	5 Driver		6 Options		
120 277	O-10V 0-10V dimming, 1% dim LE/TE TRIAC/ELV dimming DALI DALI dimming, 1% dim HILUME-H-ECO Lutron LDE1 Hi-lume® 1% Soft-On/Fade-to-Black		EM emergency battery pack with remote test switch HB49 hanger bars from min 29" to max 49"		

Trim Ordering Information

1	2	3	4	5	6	7
1 Model	2 Style		3 Finish Type			
STADIA-88 8"x8" Stadia	SST soft square trim (semi-recessed)		1T single tone 2T two tone			
4 Body Finish	5 Bevel Finish		6 Beam Spread		7 CCT-CRI	
Classic: MW matte white MB matte black SLV matte silver Glossy Hue: PGR pearl opal green (RAL 6036) PBL pearl gentian blue (RAL 5025) PRD pearl ruby red (RAL 3032) Metallic: MGD metallic gold Wood Grain: WAS wood grain ash WCH wood grain chestnut WWA wood grain walnut WEB wood grain ebony	Classic: MW matte white MB matte black SLV matte silver Glossy Hue: PGR pearl opal green (RAL 6036) PBL pearl gentian blue (RAL 5025) PRD pearl ruby red (RAL 3032) Metallic: MGD metallic gold		VWF very wide flood, 88°		279 2700K-90+ 309 3000K-90+ 359 3500K-90+ 409 4000K-90+	

PROJECT:

TYPE:

Specifications

Housing Construction

Steel frame and housing
 Die-cast aluminum outer trim and bevel
 Internal components are die-formed cold-rolled steel

Optical

Nominal 1/8" white acrylic lens for soft even illumination

LED

Color Temp Options: 2700K, 3000K, 3500K, 4000K*
 CRI: 90+ typ.
 R9 Values: > 50 (90+ CRI)
 Binning: 3 MacAdam (SDCM)

Electrical

Wattage: 9, 12, 18, 23, 34
 Electronic constant current LED driver
This product complies with IEEE C62.41 for surge endurance up to 2.5KV. Amerlux® recommends using additional surge protection with this unit (supplied by others), surge and over voltage damage is not covered under warranty.

Drivers

0-10V - 1% electronic dimming, multivolt (120-277VAC) constant current driver (standard). Cap leads for non-dim applications.
 LE/TE - Leading Edge, TRIAC, forward phase/Trailing Edge, ELV, reverse phase, dedicated voltage, (120V or 277V)
 DALI - DALI dimming, 1% dim (120-277VAC)
See pages xx for more dimming information

Mounting

For use in grid or sheetrock ceilings, 5/8" thick
 Consult factory for thicker ceilings
 26" Hanger bars included
 Consult factory for hanger bars greater than 26"

Certifications

CSA approved to UL standards as tested by CSA
 For indoor use only

Warranty

5 year limited warranty

Finish Type

Classic

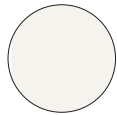

Matte White
MW



Matte Black
MB

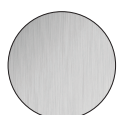

Matte Silver
SLV

Glossy Hue



Pearl Opal Green
PGR

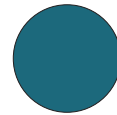

Pearl Genetian Blue
PBL

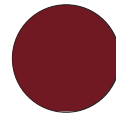

Pearl Ruby Red
PBR

Metallic



Metallic Gold
MGD

Wood Grain



Wood Grain Ash
WAS



Wood Grain Chestnut
WCH



Wood Grain Walnut
WWA



Wood Grain Ebony
WEB

PROJECT:

TYPE:

Product Detail

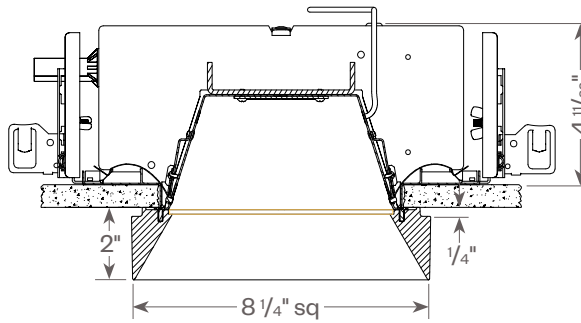
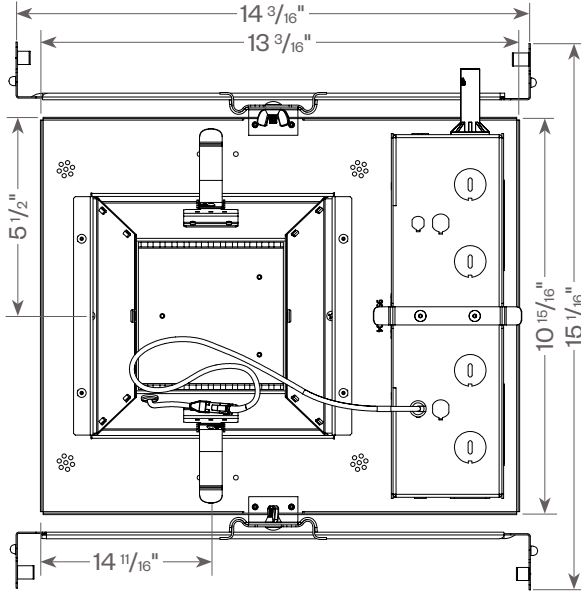

Ceiling Cutout: $6 \frac{3}{4} \text{ } ^{+0} \text{ } _{-.1/16} \text{ } \text{SQ.}$

PROJECT:

TYPE:

Fixture Data: (Complete photometric data (ies format) available upon request)

Wattage	9	12	18	23	34
Factor:	0.27	0.39	0.55	0.71	1.0

CCT	2700K-90+	3000K-90+	3500K-90+	4000K-90+
Factor:	0.93	0.97	1.0	1.02

34W 3500K-90+

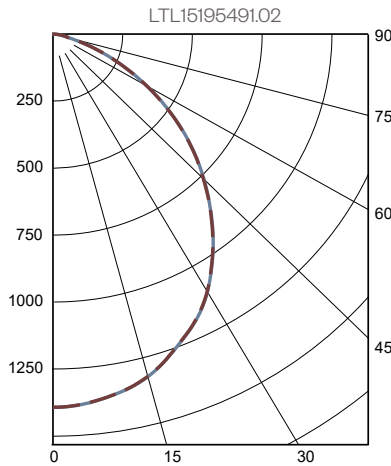

Zonal Lumen Summary

Zone	Lumens	% Luminaire
0-40	1676	53.9%
0-60	2731	87.9%
0-90	3107	100.0%
90-180	0	0.0%

Luminaire Efficacy: 91.2 lm/W

Coefficiency of Utilization

Effective Floor Cavity Reflectance 20%

RC	80			
	RW 70	50	30	10
RCR				
0	119	119	119	119
1	110	106	103	99
2	102	94	88	83
3	93	84	77	71
4	86	75	67	61
5	80	68	59	53
6	74	61	53	47
7	69	56	48	42
8	64	51	43	38
9	60	47	39	34
10	56	44	36	31

Note: Values are expressed as percent of total lumen output delivered to task surface.

Application Data

0° Aiming Angle Horizontal Footcandles

Very Wide Flood	D	FC	L	W
	5.0'	61	5.8	5.8
7.5'	27	8.8	8.8	
10.0'	15	12.3	12.3	
12.5'	10	16.2	16.2	

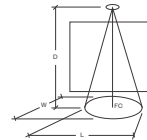

Notes and Definitions:

Beam spread is to 50% center beam candlepower (CBCP).

D=Distance to floor or wall.

FC=Footcandles on floor or wall at center beam aiming location.

L=Effective Visual Beam length in feet (50% of maximum footcandle level).

W=Effective Visual Beam width in feet (50% of maximum footcandle level).

CB=Distance across or down to center beam location.

PROJECT:

TYPE:

Dimming Compatibility

Amerlux® Stadia fixtures are compatible with all major dimming protocols prevalent in the United States. Please see below for general compatibilities and wiring diagrams. Amerlux recommends testing your unique dimming configuration as the exact full configuration (Dimmer, Fixture Quantity, Voltage, etc) may affect dimming performance.

--- NOTE: INFORMATION BELOW IS FOR WIRED DIMMERS ONLY. FOR WIRELESS DIMMERS, CONSULT FACTORY ---

TRIAC (Forward Phase) DIMMING (Standard)

Utilizes "Standard" incandescent dimmers that are in wide use in installations across the US. Best for retrofit applications where TRIAC dimmers are installed.

Notes:

- 120VAC or 277VAC*
- Dims down to less than 5% light output (most cases)
- Consult Dimming manufacturer for installation instructions - DO NOT SHARE NEUTRALS!
- Must meet dimmer Minimum Load Requirements per dimming manufacturer

TRIAC Wiring Diagram

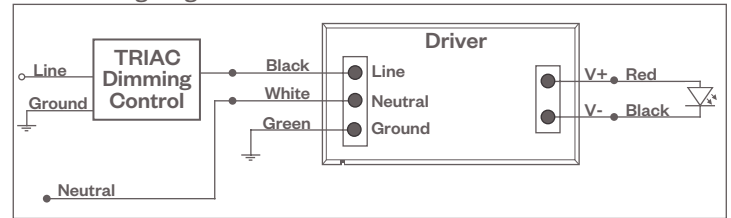

Compatible Dimmers*:

Wall Box (Incandescent Style, Wattage as required)	Central System
Lutron "Diva"	Lutron "GP" Panel
Lutron "Nova-T"	Lutron Grafik Eye QS
Lutron "Maestro"	
Lutron "Skylark"	

ELV - Electronic Low Voltage (Reverse Phase) DIMMING (Standard)

Utilizes specialized "ELV" dimmers.

Notes:

- 120VAC or 277VAC*
- Dims down to less than 5% light output (most cases)
- Consult Dimming manufacturer for installation instructions - DO NOT SHARE NEUTRALS!
- Must meet dimmer Minimum Load Requirements per dimming manufacturer

ELV Wiring Diagram

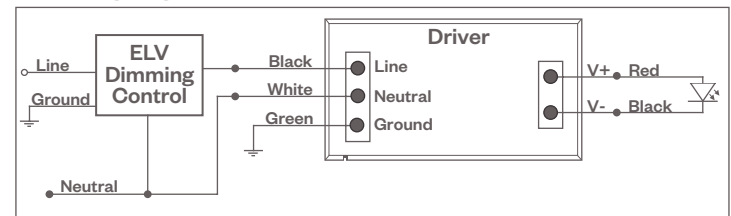

Compatible Dimmers*:

Wall Box (ELV Style)	Central System
Lutron "Diva"	Lutron "GP" Panel with PHPM-PA Interface
Lutron "Nova-T"	Lutron Grafik Eye QS with PHPM-PA Interface
Lutron "Maestro"	
Lutron "Skylark"	

0-10V Dimming

Integrates into a variety of building management and daylighting controls.

Notes:

- 120VAC or 277VAC*
- Dims down to 1% light output
- Consult Dimming manufacturer for installation instructions - DO NOT SHARE NEUTRALS!

0-10V Wiring Diagram

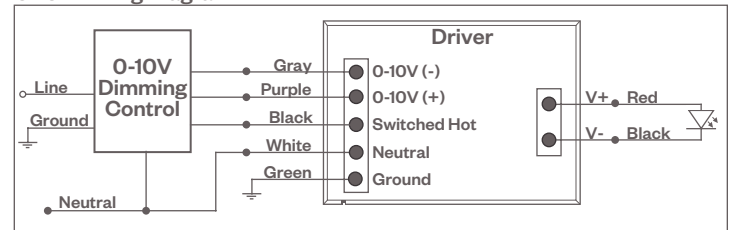

Compatible Dimmers*:

Wall Box	Central System
Lutron "Diva" - DVSTV	Lutron Grafik Eye with GRX-TVI Interface

Notes:

* Driver is 277VAC dimmable with appropriate dimmer (by others). All provided wiring diagrams show 120VAC wiring colors and method.

Please refer to 277VAC dimmer installation instructions for 277VAC wiring diagrams.

† The absence of a dimmer from the lists above does not imply incompatibility. Please consult factory for compatibility inquiries.

PROJECT:

TYPE:

Dimming Compatibility

Amerlux® Stadia fixtures are compatible with all major dimming protocols prevalent in the United States. Please see below for general compatibilities and wiring diagrams. Amerlux recommends testing your unique dimming configuration as the exact full configuration (Dimmer, Fixture Quantity, Voltage, etc) may affect dimming performance.

--- NOTE: INFORMATION BELOW IS FOR WIRED DIMMERS ONLY. FOR WIRELESS DIMMERS, CONSULT FACTORY ---

Lutron LDE1 Dimming

Integrates into Lutron EcoSystem building management controls.

Notes:

- 120VAC or 277VAC*
- Dims down to 1% Soft-On/Fade-to-Black
- Consult Dimming manufacturer for installation instructions - DO NOT SHARE NEUTRALS!

Compatible Dimmers†:

Lutron ECO System	Central System
Pow Pak Dimming Modules	Lutron "GP" Panel
Energi Savr Node	Lutron Grafik Eye QS
Grafik Eye QS/Homeworks	
QS Control Unit	
Quantum Hub	
Homeworks QS/My Room	

Lutron LDE1 (HILUME-H-ECO) EcoSystem Digital Control Wiring Diagram

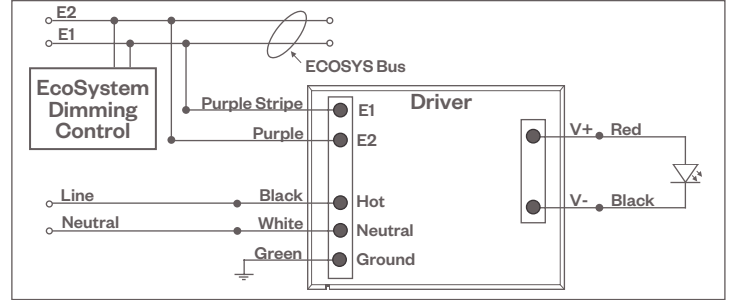

Emergency Dimming

Wiring Diagram

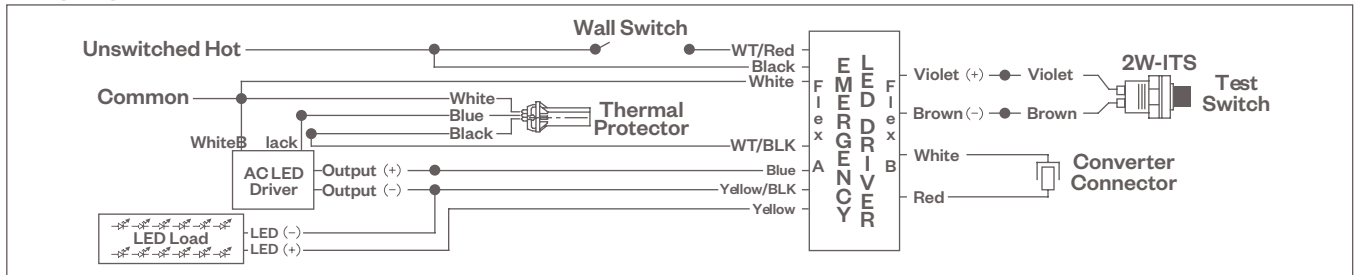

Notes:

- * Driver is 277VAC dimmable with appropriate dimmer (by others). All provided wiring diagrams show 120VAC wiring colors and method. Please refer to 277VAC dimmer installation instructions for 277VAC wiring diagrams.
- † The absence of a dimmer from the lists above does not imply incompatibility. Please consult factory for compatibility inquiries.