

Hornet[®] HP

Square Lensed Downlight/
Wall Wash
Dim-To-Warm



Features

Add ambiance to any hospitality, residential, retail or commercial space. Amerlux Hornet HP Downlight Dim-To-Warm option offers a lower kelvin temperature as you dim the lights. An adaptable light source in a cost-effective, solid state lighting package. The Dim-To-Warm option can tap into the powerful mediums of light and color to enhance the experience, well-being, and human emotion. Amerlux Dim-To-Warm allows designers to simulate the familiar glow and dimming of incandescent lamps. Available for trimmed, trimless or millwork applications.

Product Overview

Type:	Recessed Square Lensed Downlight/Wall Wash
Wattage:	15W
Lumen Output:	SLD (30SOL): 841 lm; SLW: 871 lm
Color Temp:	3000K to 1800K
CRI:	95 typ.
Dimming:	TRIAC & ELV (120/277VAC) - 5% Dim Lutron LDE1 Hi-lume [®] 1% Soft-On/Fade-to-Black (120/277VAC) 0-10V (120/277VAC) - 1% Dim DALI (120/277VAC) - 1% Dim

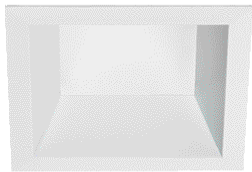

Downlight

PROJECT:

TYPE:



Trimless version



Millwork version



Wall Wash

Fixture Type

New Construction	Remodeler	Trim	Trimless
Yes	Yes	Yes	Yes

Electrical Data

	15W	
	System Watts	Amps
120V	15	0.13
277V	16	0.06

Electronic constant current LED driver
Includes thermal protector, 2W power consumption

Dim-To-Warm CCT Curve

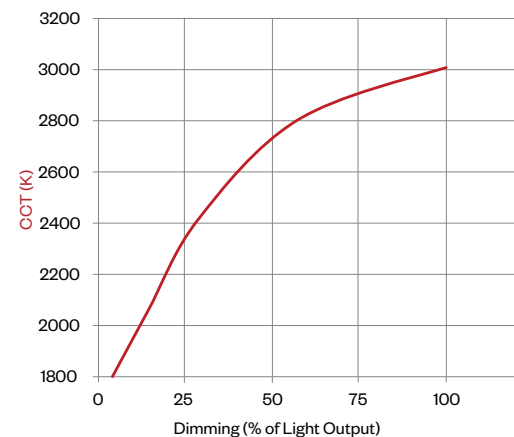

Hornet® HP

Square Lensed Downlight/Wall Wash, Dim-To-Warm



PROJECT:

TYPE:

Housing/Frame Ordering Information

		15			
1	2	3	4	5	6
<p>1 <u>Model</u> For New Construction HDL-HP-S-NC-DTW-A17[†] (New Construction) HDL-HP-S-CP-DTW-A17[†] (Chicago Plenum housing) HDL-HP-S-IC-DTW-A17[†] (Insulated Ceiling/air tight)</p> <p>For Existing Ceilings HDL-HP-S-REM-DTW- A17[†] (Remodeler)</p>	<p>2 <u>Style</u> T - trimmed TL - trimless MWK^{R†} - millwork (for 1/2" - 11/16" ceiling thickness) ^R Not available for use with Remodeler model [†] For SLD Trim consult factory for use in ceilings thicker than 11/16"; For SLW Trim max ceiling thickness is 11/16"</p>	<p>3 <u>Wattage</u> 15</p>	<p>4 <u>Voltage</u> 120 277 120/277 (for use with IC housing only)</p>	<p>5 <u>Driver</u> LE/TE - TRIAC/ELV dimming HILUME-H-ECO - Lutron LDE1 Hi-lume® 1% Soft-On/ Fade-to-Black 0-10V - 0-10V dimming, 1% dim DALI - DALI dimming, 1% dim</p>	<p>6 <u>Options/Accessories</u> EM - emergency battery pack with remote test switch (not available for use with REM, CP or IC options) HB49 - hanger bars from min 29" to max 49" (not available for use with REM options)</p>

Trim Ordering Information

				309			
1	2	3	4	5	6		
<p>1 <u>Model</u> HDL-HP-SLD-DTW-A17[†] (lensed downlight) HDL-HP-SLW-DTW-A17[†] (lensed wall wash)</p>	<p>2 <u>Style</u> T - trimmed TL - trimless MWK - millwork (SLW trim max 3/4" thick millwork)</p>	<p>3 <u>Finish</u></p> <table border="0"> <tr> <td style="vertical-align: top;"> <p><u>Trimmed</u> MBW - matte black, white flange MWW - matte white, white flange SLVW - matte silver, white flange MBB - matte black, black flange SLVS - matte silver, silver flange</p> </td> <td style="vertical-align: top;"> <p><u>Trimless/Millwork</u> MB - matte black MW - matte white SLV - matte silver</p> </td> </tr> </table>	<p><u>Trimmed</u> MBW - matte black, white flange MWW - matte white, white flange SLVW - matte silver, white flange MBB - matte black, black flange SLVS - matte silver, silver flange</p>	<p><u>Trimless/Millwork</u> MB - matte black MW - matte white SLV - matte silver</p>	<p>4 <u>Beam Spreads</u> (not required with SLW version) 30SOL - 30° beam with solite lens 50SOL - 50° beam with solite lens 65SOL - 65° beam with solite lens</p>	<p>5 <u>Color Temp</u> 95 CRI 309 - 3000K-95</p>	<p>6 <u>Options/Accessories</u> WET - wet location (only available for use with trimmed style)</p>
<p><u>Trimmed</u> MBW - matte black, white flange MWW - matte white, white flange SLVW - matte silver, white flange MBB - matte black, black flange SLVS - matte silver, silver flange</p>	<p><u>Trimless/Millwork</u> MB - matte black MW - matte white SLV - matte silver</p>						

[†] The "A" refers to the sequential revision in a year and "XX" refers to the year of update. Updates coincide with improved performance while not changing the overall fixture aesthetic and are reflected in the published performance data. Please contact your Amerlux representative for explanations of changes.

Hornet® HP

Square Lensed Downlight/Wall Wash, Dim-To-Warm



PROJECT:

TYPE:

Specifications

Application

Hospitality and commercial ambient or wall wash lighting

Construction

- 20 ga. galvanized steel frame
- 18 ga. galvanized steel splice housing and hanger brackets (not for Remodeler version)
- Cast aluminum plaster frame with perforated face (for trimless version only)
- Die-cast optical housing and trim
- Die-cast heat sink

Optical

Lens Options (for SLD version):

Solite lens for maximum efficacy and a visually quieter aperture. 30°, 50° and 65° beam spread options. Visually best with SLV reflector finish.

Beam spreads (for SLD version):

- 30SQL - 30° beam with solite lens
- 50SQL - 50° beam with solite lens
- 65SQL - 65° beam with solite lens

Wall Wash:

Engineered nano technology lens provides high transmission while concealing LED image

LED

Color Temp Options:

- 3000K (Dims to 1800K)
- CRI: 95 typ. (± 3 across dimming range)
- R9 Values: 85 (95+ CRI)
- Binning: 3 MacAdam (SDCM)
- Life: 50,000+ hrs, > 70% of initial lumens at 50,000 hrs

Electrical

Wattage: 15

Electronic constant current LED driver, 120/277VAC input
This product complies with IEEE C62.41 for surge endurance up to 2.5KV. Amerlux® recommends using additional surge protection with this unit (supplied by others), surge and over voltage damage is not covered under warranty.

Note: Drivers are universal input voltage but thermal protector is voltage specific

Drivers

LE/TE - Leading Edge, TRIAC, forward phase/Trailing Edge, ELV, reverse phase
0-10V, Lutron and DALI systems available
See pages 10-12 for more dimming information

Finish

Powder coat paint/wet paint
Consult factory for custom finishes

Mounting

26" Hanger bars included (except for Remodeler versions)
Optional **HB49** - hanger bars from min 29" to max 49" available

Trimmed Fixture:

For use in grid or sheetrock ceilings, 5/8" - 2" max (1" max for SLW trim) standard

Trimless Fixture:

For use in sheetrock ceilings, max ceiling thickness 5/8"

Millwork Fixture:

Millwork extension collars are based on ceiling material specifications and thickness. Provides flush trim appearance level with ceiling material.

For **SLD** trim - ceiling thickness 1/2" - 11/16", consult factory for use in thicker ceilings.

For **SLW** trim - max ceiling thickness is 11/16".

Not available for use with Remodeler model

Certifications

- CSA damp as tested to UL 1598 standards
- CP - Chicago Plenum (CCEA) option
- IC/AT rated (optional)
- Damp location
- Wet location option
- JA10 compliant for Title 24 per UL Test 13005791.01A (available upon request)

Warranty

5 year limited warranty

Emergency Battery Pack (EM)

Powers fixture at 5.1 watts (approx. 300 Lm) for 90 minutes
(not for use with REM, CP or IC/AT versions)

Hornet[®] HP

Square Lensed Downlight/Wall Wash, Dim-To-Warm



PROJECT:

TYPE:

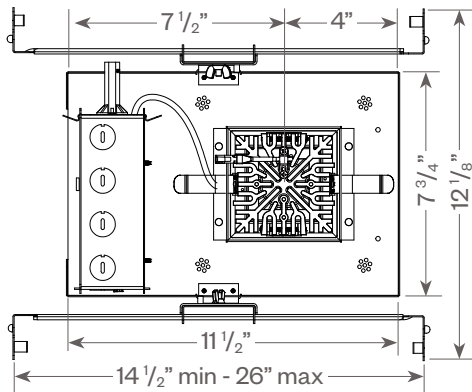

Optional CP or IC/AT housing

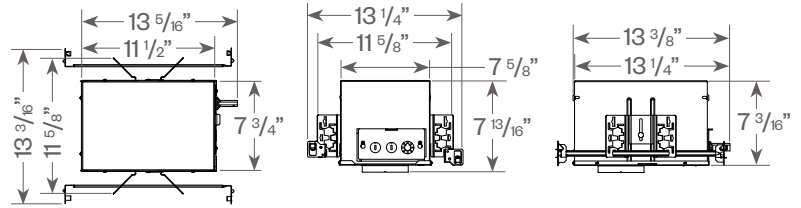

Emergency Battery Pack (EM) option

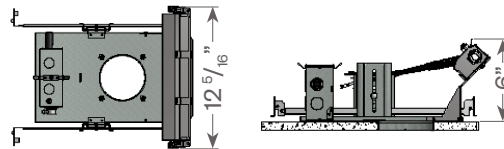

Hornet HP Square Lensed Downlight:

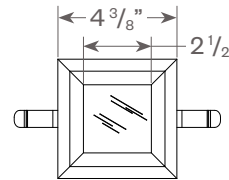
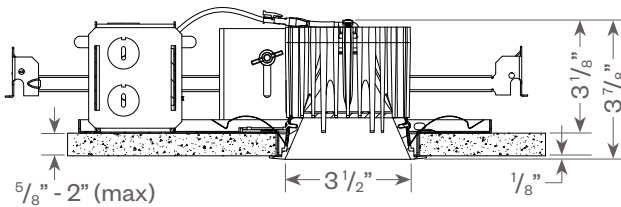

Ceiling cut out: 4" sq.

Hornet HP Square Lensed Wall Wash:

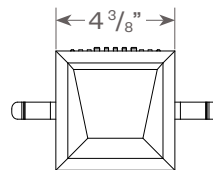
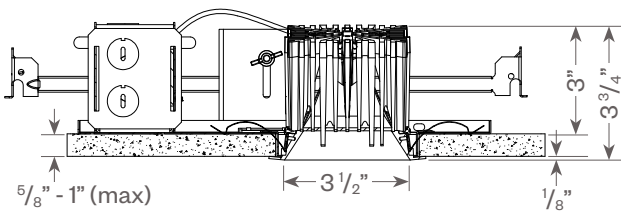

Ceiling cut out: 4" sq.

DTW Hornet HP SLD/SLW

Hornet® HP

Square Lensed Downlight/Wall Wash, Dim-To-Warm



PROJECT:

TYPE:

Hornet HP Square Lensed Downlight:

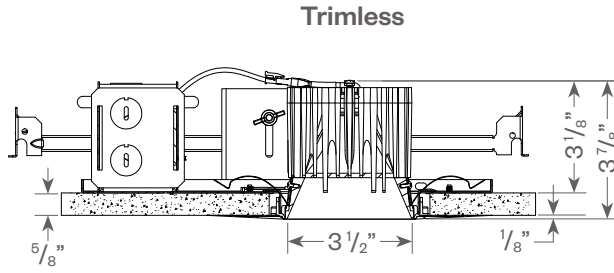

Trimless Ceiling cut out: 4 1/2" sq.

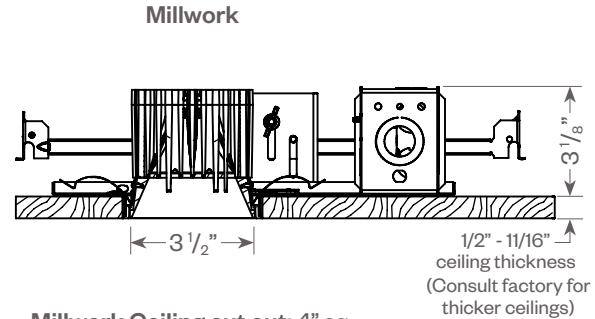
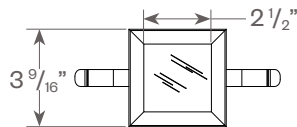

Millwork Ceiling cut out: 4" sq.

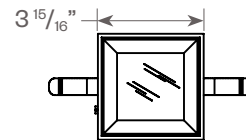

Hornet HP Square Lensed Wall Wash:

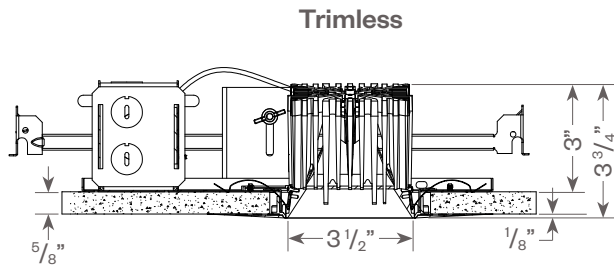

Trimless Ceiling cut out: 4 1/2" sq.

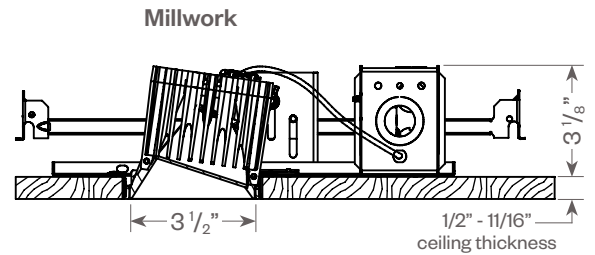
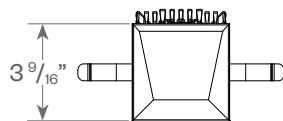

Millwork Ceiling cut out: 4" sq.

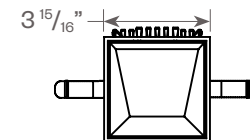

Plaster Frame Installation Detail (for trimless fixture only)

1. Reflector Trim
2. Aperture plate
3. Ceiling 5/8"
4. Cast Aluminum Plaster Frame
5. Plaster Skim Coat (by others)
6. 6-32 Type F Thread Cutting Screw

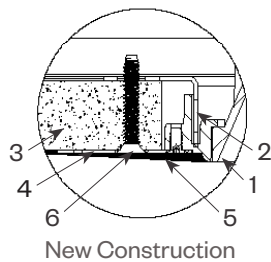

Millwork Detail

1. Reflector Trim
2. Millwork Ring
3. Aperture Plate
4. Wood Ceiling 2" Max
5. Extension collar (see ordering information for ceiling thicknesses)
6. 1/16" required for trim to be flush with ceiling

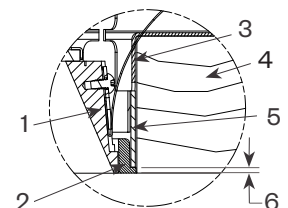

Hornet[®] HP

Square Lensed Downlight/Wall Wash, Dim-To-Warm



PROJECT:

TYPE:

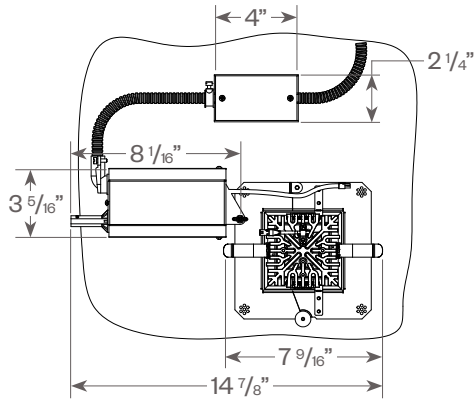

Hornet HP Square Lensed Downlight Remodeler:

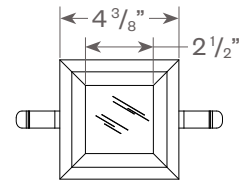
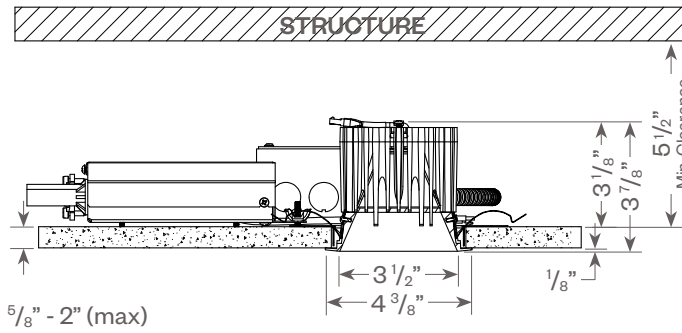

Ceiling cut out: 4" sq.

Hornet HP Square Lensed Wall Wash Remodeler:

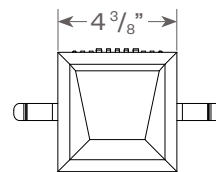
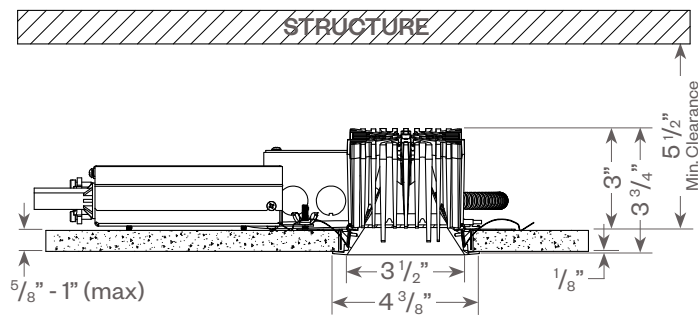

Ceiling cut out: 4" sq.

Hornet[®] HP

Square Lensed Downlight/Wall Wash, Dim-To-Warm



PROJECT:

TYPE:

Hornet HP Square Lensed Downlight Remodeler:

Trimless

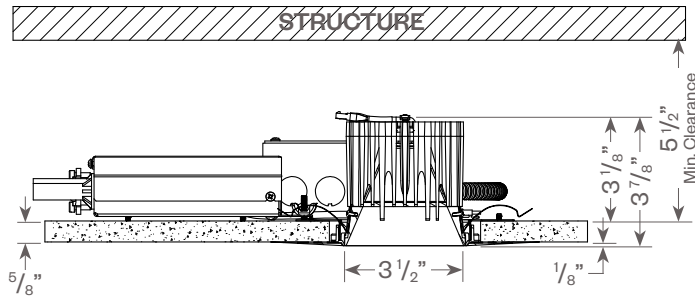

Trimless Ceiling cut out: 4 1/2" sq.

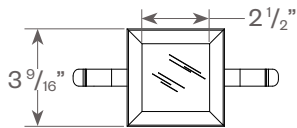

Hornet HP Square Lensed Wall Wash Remodeler:

Trimless

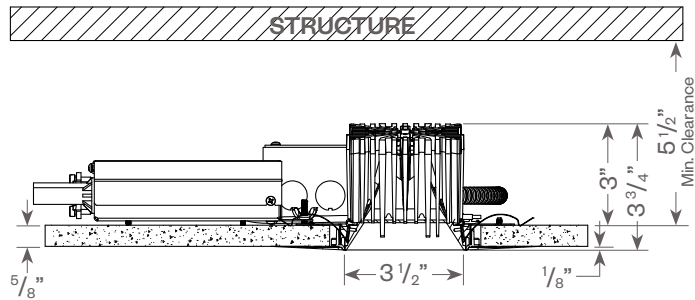

Trimless Ceiling cut out: 4 1/2" sq.

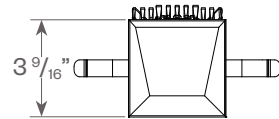

Plaster Frame Installation Detail (for trimless fixture only)

1. Reflector Trim
2. Aperture plate
3. Ceiling 5/8"
4. Cast Aluminum Plaster Frame
5. Plaster Skim Coat (by others)
6. 6-32 Type F Thread Cutting Screw

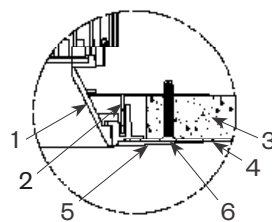

Remodeler

PROJECT:

TYPE:

Hornet HP Square Lensed Downlight:

FIXTURE DATA: (Complete photometric data (.ies format) available upon request)

15W LED, 3000K-95

30° Solite Lens
LTL # 11919582.27
Lumens: 841

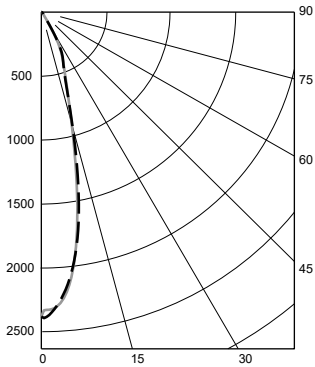

Candelas at Nadir

Deg	Candela
0	2380
5	2209
15	923
25	387
35	57
45	21

50° Solite Lens
LTL # 11919582.28
Lumens: 834

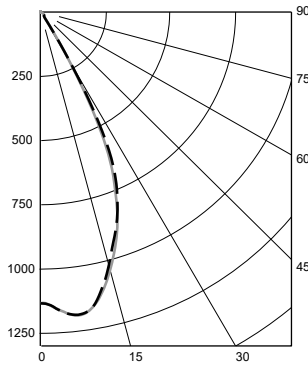

Candelas at Nadir

Deg	Candela
0	1133
5	1176
15	1043
25	644
35	54
45	21

65° Solite Lens
LTL # 11919582.29
Lumens: 823

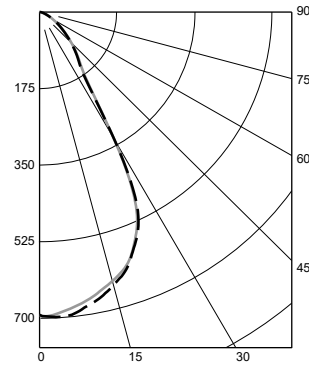

Candelas at Nadir

Deg	Candela
0	692
5	685
15	636
25	521
35	179
45	104

Application Data:

Notes and Definitions:

Beam spread is to 50% center beam candlepower (CBCP).

D=Distance to floor or wall.

FC=Footcandles on floor or wall at center beam aiming location.

L=Effective Visual Beam length in feet (50% of maximum footcandle level).

W=Effective Visual Beam width in feet (50% of maximum footcandle level).

CB=Distance across or down to center beam location.

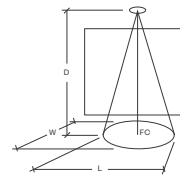

**0° Aiming Angle
Horizontal
Footcandles**

Lens	D	FC	L	W
	30° Solite Lens	5.0'	96	2.3
7.5'		43	3.3	3.4
10.0'		24	4.4	4.6
12.5'		15	5.5	5.6
50° Solite Lens	5.0'	46	4.3	4.3
	7.5'	21	6.4	6.4
	10.0'	12	8.4	8.4
	12.5'	8	10.5	10.6
65° Solite Lens	5.0'	28	4.8	4.8
	7.5'	13	7.4	7.4
	10.0'	7	10.1	10.1
	12.5'	5	12.7	12.7

Hornet[®] HP

Square Lensed Downlight/Wall Wash, Dim-To-Warm



PROJECT:

TYPE:

Hornet HP Square Lensed Wall Wash:

FIXTURE DATA: (Complete photometric data (.ies format) available upon request)

15W 3000K-95

Lumens: 871

LTL# 11919582.31

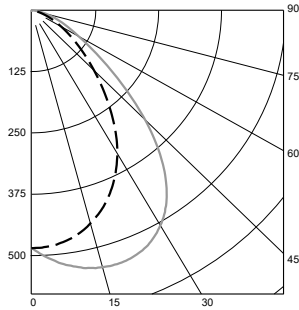

ZONAL LUMEN SUMMARY

Zone	Lumens	%Fixt
0-40	540	62.0
0-60	795	91.2
0-90	871	100.0
90-180	0	0.0

Luminaire Efficacy: 59.2 lm/W

Application Data:

Footcandles on Wall

Footcandles are average and rounded off.
Data for multiple units are based on a minimum of five units.

1.5 Feet from Wall

Distance from ceiling	← 1.5' → ← 1.5' →					
	0.5'	1.5'	2.5'	3.5'	4.5'	5.5'
0.5'	29	30	30	30	29	
1.5'	68	71	72	71	68	
2.5'	62	66	67	66	62	
3.5'	38	72	73	72	39	
4.5'	24	26	27	27	24	
5.5'	16	18	18	18	16	
6.5'	12	13	13	13	12	
7.5'	9	10	10	10	9	

1.5 Feet from Wall

Distance from ceiling	← 2' → ← 2' →					
	0.5'	1.5'	2.5'	3.5'	4.5'	5.5'
0.5'	22	24	22	24	21	21
1.5'	52	56	54	56	53	52
2.5'	48	51	51	52	51	48
3.5'	30	33	34	34	33	31
4.5'	19	21	22	22	21	20
5.5'	13	15	15	16	15	14
6.5'	10	11	11	11	11	10
7.5'	8	8	9	9	8	8

2 Feet from Wall

Distance from ceiling	← 2' → ← 2' →					
	0.5'	1.5'	2.5'	3.5'	4.5'	5.5'
0.5'	11	12	12	13	12	12
1.5'	33	35	35	35	35	33
2.5'	42	44	45	45	44	42
3.5'	32	35	36	36	35	32
4.5'	22	25	26	26	25	23
5.5'	16	18	18	19	18	16
6.5'	12	13	14	14	13	12
7.5'	9	10	10	11	10	9

Hornet[®] HP

Square Lensed Downlight/Wall Wash, Dim-To-Warm



PROJECT:

TYPE:

DIMMING COMPATIBILITY:

Amerlux[®] Hornet fixtures are compatible with all major dimming protocols prevalent in the United States. Please see below for general compatibilities and wiring diagrams. Amerlux recommends testing your unique dimming configuration as the exact full configuration (Dimmer, Fixture Quantity, Voltage, etc) may affect dimming performance.

--- NOTE: INFORMATION BELOW IS FOR WIRED DIMMERS ONLY. FOR WIRELESS DIMMERS, CONSULT FACTORY ---

TRIAC (Forward Phase) DIMMING (Standard)

Utilizes standard TRIAC dimmers that are in wide use in installations across the US. Best for retrofit applications where TRIAC dimmers are installed.

Notes:

- 120VAC or 277VAC*
- Dims down to 5% light output (most cases)
- Consult Dimming manufacturer for installation instructions - DO NOT SHARE NEUTRALS!
- Must meet dimmer Minimum Load Requirements per dimming manufacturer

TRIAC Wiring Diagram

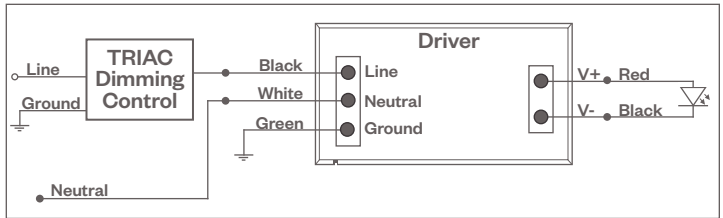

Compatible Dimmers†:

Wall Box (TRIAC 120VAC)	Central System
Lutron "Diva"	Lutron "GP" Panel
Lutron "Nova-T"	Lutron Grafik Eye QS
Lutron "Maestro"	
Lutron "Skylark"	

ELV - Electronic Low Voltage (Reverse Phase) DIMMING (Standard)

Utilizes specialized "ELV" dimmers.

Notes:

- 120VAC or 277VAC*
- Dims down to 5% light output (most cases)
- Consult Dimming manufacturer for installation instructions - DO NOT SHARE NEUTRALS!
- Must meet dimmer Minimum Load Requirements

ELV Wiring Diagram

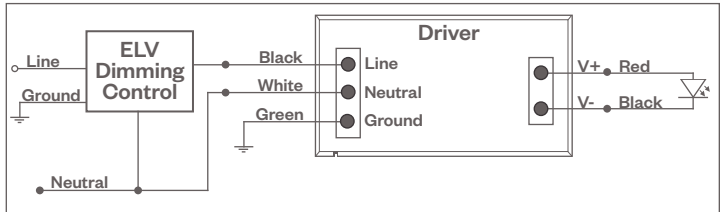

Compatible Dimmers†:

Wall Box (ELV 120VAC)	Wall Box (ELV 277VAC)	Central System
Lutron "Diva"	Leviton Revoir II AWSMT-E	Lutron "GP" Panel with PHPM-PA 120/277VAC
Lutron "Nova-T"		Lutron Grafik Eye QS with PHPM-PA 120/277VAC
Lutron "Maestro"		
Lutron "Skylark"		
Leviton "Surslide"		
Leviton "Vizio"		

Notes:

- * Driver is 277VAC dimmable with appropriate dimmer (by others). All provided wiring diagrams show 120VAC wiring colors and method. Please refer to 277VAC dimmer manufacturer installation instructions for 277VAC wiring diagrams.
- † The absence of a dimmer from the lists above does not imply incompatibility. Please consult factory for compatibility inquiries.

Hornet[®] HP

Square Lensed Downlight/Wall Wash, Dim-To-Warm



PROJECT:

TYPE:

DIMMING COMPATIBILITY:

Amerlux[®] Hornet fixtures are compatible with all major dimming protocols prevalent in the United States. Please see below for general compatibilities and wiring diagrams. Amerlux recommends testing your unique dimming configuration as the exact full configuration (Dimmer, Fixture Quantity, Voltage, etc) may affect dimming performance.

--- NOTE: INFORMATION BELOW IS FOR WIRED DIMMERS ONLY. FOR WIRELESS DIMMERS, CONSULT FACTORY ---

0-10V DIMMING

Integrates into a variety of building management and daylighting controls

Notes:

- 120VAC or 277VAC*
- Dims down to 1% light output
- Requires interface to turn off power to driver
- Consult Dimming manufacturer for installation instructions - DO NOT SHARE NEUTRALS!

0-10V Wiring Diagram

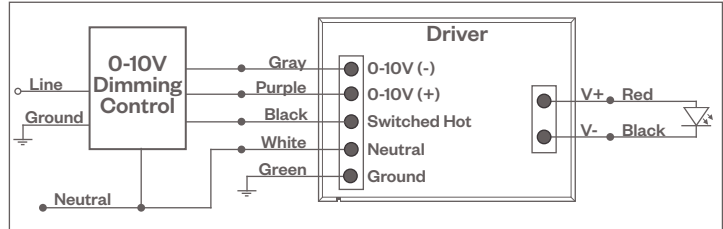

Compatible Dimmers*:

Wall Box

Lutron "Diva" - DVSTV | Leviton Renoir II 0-10V

Central System

Lutron Grafik Eye with GRX-TV1 Interface

LUTRON LDE1 DIMMING

Integrates into Lutron EcoSystem building management

Notes:

- 120VAC or 277VAC*
- Dims down to 1% Soft-On/Fade-to-Black
- EcoSystem Control
- Consult Dimming manufacturer for installation instructions - DO NOT SHARE NEUTRALS!

Lutron LDE1 (HILUME-H-ECO)

EcoSystem Digital Control Wiring Diagram

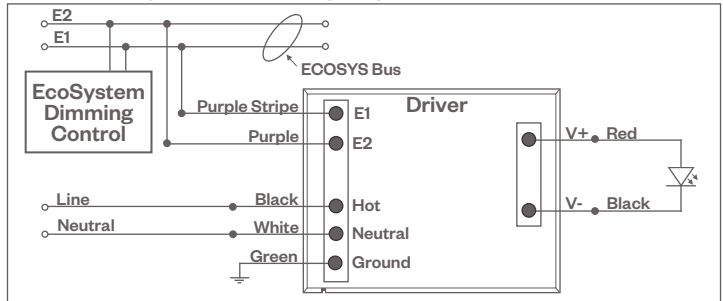

Compatible Dimmers*:

Lutron ECO System

Pow Pak Dimming Modules
Energj Savr Node
Grafik Eye QS/Homeworks
QS Control Unit
Quantum Hub
Homeworks QS/My Room

Central System

Lutron EcoSystem compatible controls

DALI DIMMING

Digital control protocol allows individual fixture control

Notes:

- 120VAC - 277VAC*
- Dims down to 1% light output in most cases

DALI Wiring Diagram

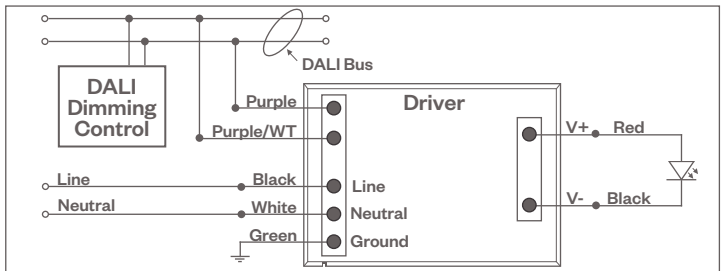

Compatible Dimmers*:

Wall Box (3-Wire Fluorescent)

Leviton CD250 Controller

Central System

Dynalite
Fifth Light

Notes:

- * Driver is 277VAC dimmable with appropriate dimmer (by others). All provided wiring diagrams show 120VAC wiring colors and method. Please refer to 277VAC dimmer manufacturer installation instructions for 277VAC wiring diagrams.
- † The absence of a dimmer from the lists above does not imply incompatibility. Please consult factory for compatibility inquiries.

Hornet[®] HP

Square Lensed Downlight/Wall Wash, Dim-To-Warm



PROJECT:

TYPE:

EMERGENCY DIMMING (-EM OPTION)

Wiring Diagram

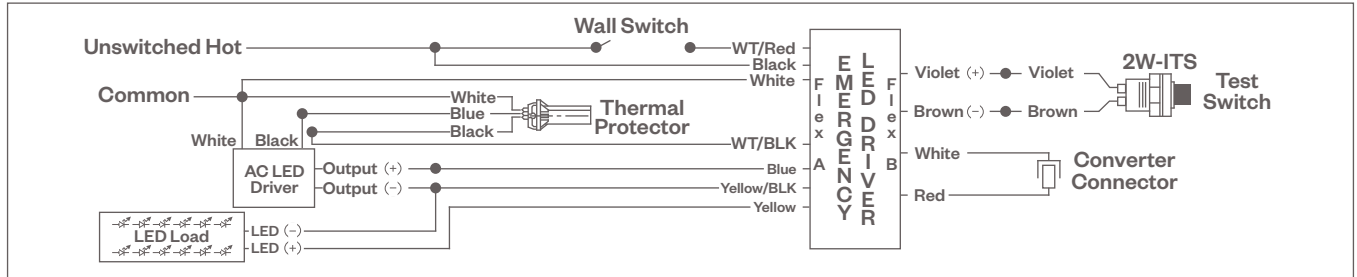

DTW Hornet HP SLD/SLW