

Hornet® HP

Round Lensed Downlight/Wall Wash



PROJECT:

TYPE:

Features

Hornet Lensed Downlights are the perfect choice for all general lighting needs. Available in Round or Square apertures, these fixtures meet the needs of commercial and hospitality markets. Optional Solite lensing provides whisper quiet aesthetics. Also available in knife-edge trimless, remodeler or millwork. Complementing Hornet Lens Wall Wash fixture available.



HDL-HP-RLD

Product Overview

Type: Recessed Round Lensed Downlight/Wall Wash
Wattage: 9W, 12W, 16W, 23W, 27W, 30W
Color Temp: 2200K, 2700K, 3000K, 3500K, 4000K
CRI: 83 typ. (2700K, 3000K, 3500K, 4000K)
 90+ typ. (2200K, 2700K, 3000K, 3500K, 4000K)
 CrispWhite & 3K Class A available
Dimming: TRIAC & ELV, 5% Dim, 120/277VAC
 Lutron LDE1 Hi-lume® 1% Soft-On/Fade-to-Black, 120/277VAC
 0-10V, 1% Dim, 120/277VAC
 DALI, 1% Dim, 120/277VAC



HDL-HP-RLW

Certifications



5 year limited warranty
AMERLUX LED



Fixture Summary

Performance Data

Watts	HDL-HP-RLD				HDL-HP-RLW		
	Delivered Lumens	LPW	CBCP	Color Temp-CRI	Delivered Lumens	LPW	Color Temp-CRI
9	796	88.5	2147	3000K-83	771	85.6	3000K-83
12	1062	88.5	2862	3000K-83	1028	85.6	3000K-83
16	1409	88	3798	3000K-83	1363	85.2	3000K-83
23	2042	90.5	5504	3000K-83	1976	87.9	3000K-83
27	2389	88.5	6440	3000K-83	2371	87.8	3000K-83
30	2654	88.5	7155	3000K-83	2569	85.6	3000K-83

Data is based on 3000K-83 120V IES files available on website.

HDL-HP-RLD data is based on 30SQL optic.

All wattages and LPW's include 2W for thermal protector.

Electrical Data

Voltage	9W		12W		16W		23W		27W		30W	
	System Watts	Amps	System Watts	Amps	System Watts	Amps	System Watts	Amps	System Watts	Amps	System Watts	Amps
120V	9.8	0.08	11.9	0.10	15.2	0.13	22.8	0.19	27.3	0.23	32	0.27
277V	9.8	0.04	11.9	0.04	15.2	0.06	22.8	0.08	27.3	0.10	32	0.12

Electronic constant current LED driver.

Includes thermal protector, 2W power consumption.

Hornet® HP

Round Lensed Downlight/Wall Wash



PROJECT:	TYPE:
----------	-------

Ordering Information - Housing/Frame

1	2	3	4	5	6
1 Model	2 Style	3 Wattage			
<p><u>For New Construction</u></p> <p>HDL-HP-R-NC-A17 (New Construction)</p> <p>HDL-HP-R-CP-A17 (Chicago Plenum (CCEA) housing)</p> <p>HDL-HP-R-IC-A17^{T24} (Insulated Ceiling/air tight, 16W max)</p> <p><u>For Existing Ceilings</u></p> <p>HDL-HP-R-REM-A17 (Remodeler)</p>	<p>T trimmed</p> <p>TL trimless</p> <p>MWK^{R†} millwork (for 1/2" - 11/16" ceiling thickness)</p> <p>^R Not available for use with Remodeler model</p> <p>[†] Consult factory for use in ceilings thicker than 11/16"</p>	<p>9</p> <p>12</p> <p>16^{T24}</p> <p>23*</p> <p>27*</p> <p>30*</p> <p>* Not available for use with IC housing</p>			
4 Voltage	5 Driver (for non-dimming, select LE/TE option)		6 Options/Accessories		
<p>120</p> <p>277</p> <p>120/277 (for use with IC housing only)</p>	<p>LE/TE^{T24} TRIAC/ELV dimming</p> <p>HILUME-H-ECO - Lutron LDE1 Hi-lume®</p> <p>1% dim Soft-On/Fade-to-Black</p> <p>0-10V^{T24} 0-10V dimming, 1% dim</p> <p>DALI DALI dimming, 1% dim</p>		<p>EM - emergency battery pack with remote test switch (not available for use with REM, CP or IC options)</p> <p>HB49 - hanger bars from min 29" to max 49" (not available for use with REM options)</p> <p>Note: 26" hanger bars are included as standard.</p> <p>Choose HB49 option above for larger mounting spaces only.</p>		

Ordering Information - Trim

1	2	3	4	5	6
1 Model	2 Style	3 Finish			
<p>HDL-HP-RLD-A17 (lensed downlight)</p> <p>HDL-HP-RLW-A17 (lensed wall wash)</p>	<p>T trimmed</p> <p>TL trimless</p> <p>MWK millwork</p>	<p><u>Trimmed</u></p> <p>MBW matte black, white flange</p> <p>MWW matte white, white flange</p> <p>SLVW matte silver, white flange</p> <p>MBB matte black, black flange</p> <p>SLVW matte silver, silver flange</p>	<p><u>Trimless/Millwork</u></p> <p>MB matte black</p> <p>MW matte white</p> <p>SLV matte silver</p>		
4 Beam Spread (not required for RLW fixture)	5 Color Temp		6 Options/Accessories		
<p>30SOL 30° beam with solite lens</p> <p>50SOL 50° beam with solite lens</p> <p>65SOL 65° beam with solite lens</p> <p>75SAT 75° beam with satin ice lens</p>	<p>83 CRI 90+ CRI^{T24}</p> <p>27 2700K-83 229 2200K-90+ CRISP[†] CrispWhite</p> <p>30 3000K-83 279 2700K-90+ 3CLA[†] 3000K Class A</p> <p>35 3500K-83 309 3000K-90+</p> <p>40 4000K-83 359 3500K-90+</p> <p style="text-align: right;">409 4000K-90+</p> <p>* Not available for 27W & 30W</p>		<p>WET wet location (only available for use with trimmed style)</p>		

^{T24} JA8/Title 24 Compliant

Hornet® HP

Round Lensed Downlight/Wall Wash



PROJECT:

TYPE:

Specifications

Application

Retail and commercial ambient or wall wash lighting

Construction

20 ga. galvanized steel frame
18 ga. galvanized steel splice housing and hanger brackets (*not for Remodeler version*)
Cast aluminum plaster frame with perforated face (*for trimless version only*)
Die-cast optical housing and trim
Die-cast heat sink

Optical

Lens Options (*for RLD version*):

Satin Ice lens for maximum source concealment and wide distribution with a visually “hotter” aperture.

Solite lens for maximum efficacy and a visually quieter aperture. 30°, 50° and 65° beam spread options. Visually best with SLV reflector finish.

Beam Spreads (*for RLD version*):

30SOL - 30° beam with solite lens

50SOL - 50° beam with solite lens

65SOL - 65° beam with solite lens

75SAT - 75° beam with satin ice lens

Wall Wash (*for RLW version*):

Engineered nano technology lens provides high transmission while concealing LED image

LED

Color Temp Options: 2200K, 2700K, 3000K, 3500K, 4000K

CRI: 83 typ. (2700K, 3000K, 3500K, 4000K)

90+ typ. (2200K, 2700K, 3000K, 3500K, 4000K)

CrispWhite* and Class A** 3000K LEDs available

R9 Values: 11 (83 CRI), 55 (92 CRI)

Binning: 3 MacAdam (SDCM)

Life: 50,000+ hrs, > 70% of initial lumens at 50,000 hrs

* **CrispWhite**: CrispWhite Technology delivers the warmth of colors expected from a high 90 CRI solution but also creates the natural crisp white color that is pleasing to the eye. It creates the most impactful lighting ever available, by revealing the richest whites and vibrant colors that pop.

** **Class A LED**: Class A LED's have a CRI > 80 and a GAI > 80. CRI defines color “Naturalness” and GAI defines color “Saturation.” Both being high delivers rich colors and pure whites.

Electrical

Wattage: 9W, 12W, 16W, 23W, 27W, 30W

Electronic constant current LED driver, 120/277VAC input

This product complies with IEEE C62.41 for surge endurance up to 2.5KV.

Amerlux® recommends using additional surge protection with this unit (supplied by others), surge and over voltage damage is not covered under warranty.

Note: Drivers are universal but thermal protector is voltage specific.

Drivers

LE/TE - Leading Edge (*Triac, Forward Phase*) or Trailing Edge (*ELV, Reverse Phase*)

0-10V, Lutron and DALI systems also available

See pages 10-12 for more dimming information

Finish

Powder coat paint/wet paint

Consult factory for custom finishes

Mounting

26” Hanger bars included (*except for Remodeler versions*)

Optional **HB49** - hanger bars from min 29” to max 49” available

Trimmed Fixture:

For use in grid or sheetrock ceilings, 5/8” - 2” max (1” max for RLW trims) standard

Trimless Fixture:

For use in sheetrock ceilings, max ceiling thickness 5/8”

Millwork Fixture:

Millwork extension collars are based on ceiling material specifications and thickness. Provides flush trim appearance level with ceiling material. Ceiling thickness 1/2” - 11/16”.

Consult factory for use in ceilings thicker than 11/16”.

Not available for use with Remodeler model.

Certifications

CSA damp as tested to UL 1598 standards

CP - Chicago Plenum (OCEA) option

IC/AT rated (*optional, 16W only*)

JAB/Title 24 Compliant (*see ordering page for options that apply*)

Damp location

Wet location option

Warranty

5 year limited warranty

Emergency Battery Pack (EM)

Powers fixture at 5.1 watts (*approx. 400 lm*) for 90 minutes (*not for use with REM, CP or IC versions*)

Hornet® HP

Round Lensed Downlight/Wall Wash



PROJECT:

TYPE:

Product Details - Trimmed

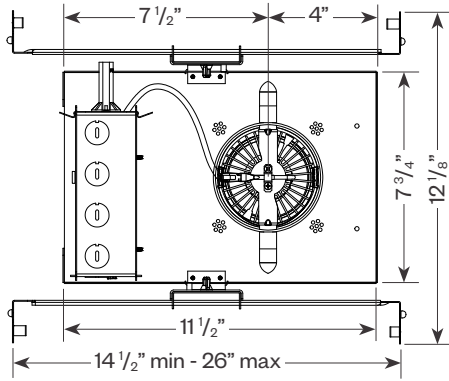

Optional CP or IC/AT housing

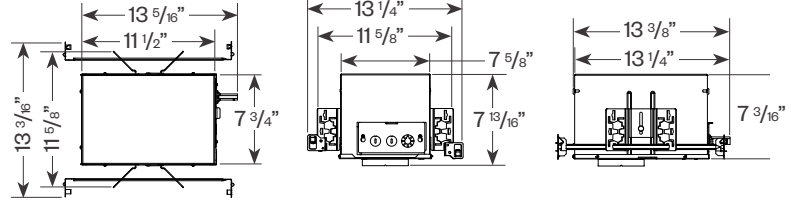

Emergency Battery Pack (EM) option

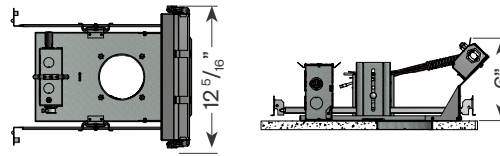

Hornet HP Round Lensed Downlight (HDL-HP-RLD)

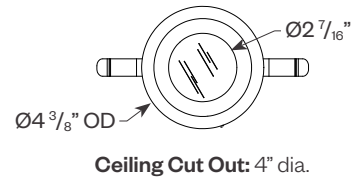
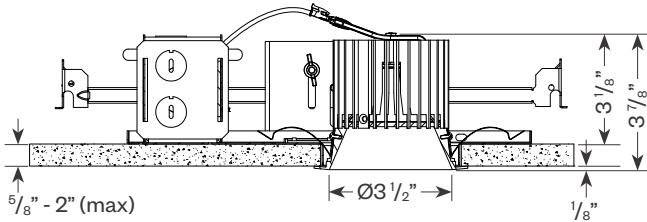

Hornet HP Round Lensed Wall Wash (HDL-HP-RLW)

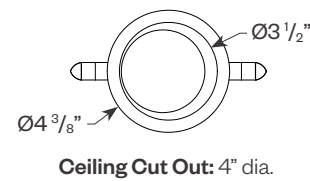
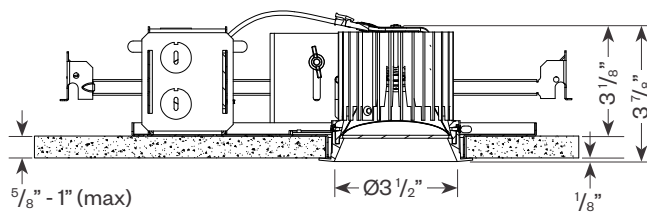

Hornet® HP

Round Lensed Downlight/Wall Wash



PROJECT:

TYPE:

Product Details - Trimless & Millwork

Hornet HP Round Lensed Downlight (HDL-HP-RLD-TL or HDL-HP-RLD-MWK)

Trimless

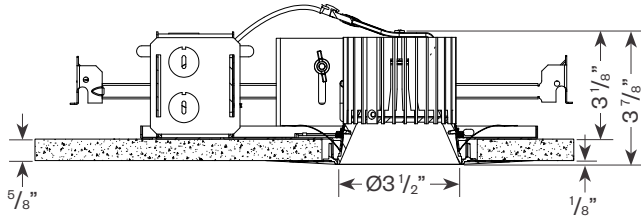

Trimless Ceiling Cut Out: 4 1/2" dia.

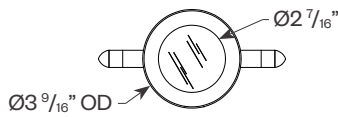

Millwork

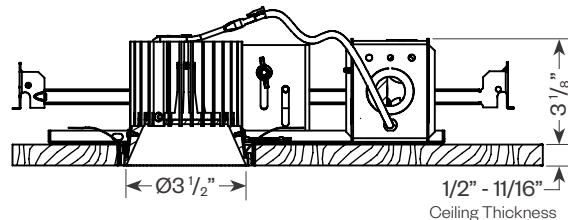

Millwork Ceiling Cut Out: 4" dia.

1/2" - 11/16"
Ceiling Thickness
(Consult factory
for thicker ceilings)

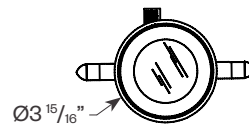

Hornet HP Round Lensed Wall Wash (HDL-HP-RLW-TL or HDL-HP-RLW-MWK)

Trimless

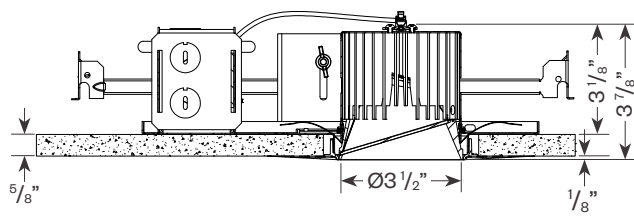

Trimless Ceiling Cut Out: 4 1/2" dia.

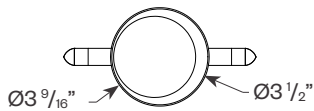

Millwork

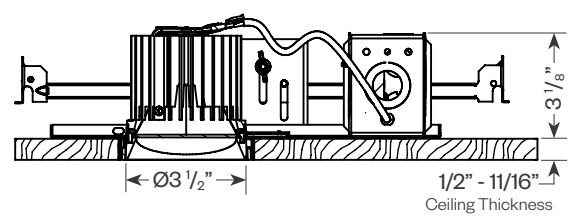

Millwork Ceiling Cut Out: 4" dia.

1/2" - 11/16"
Ceiling Thickness
(Consult factory
for thicker ceilings)

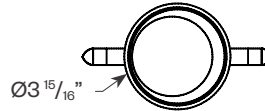

Plaster Frame Installation Detail (for trimless fixture only)

1. Reflector Trim
2. Aperture Plate
3. Ceiling 5/8"
4. Cast Aluminum Plaster Frame
5. Plaster Skim Coat (by others)
6. 6-32 Type F Thread Cutting Screw

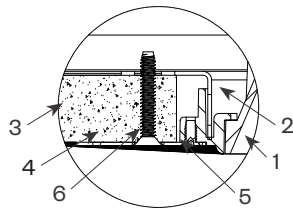

Millwork Detail

1. Reflector Trim
2. Millwork Ring
3. Aperture Plate
4. Wood Ceiling 2" Max
5. Extension Collar (see ordering information for ceiling thicknesses)
6. 1/16" required for trim to be flush with ceiling

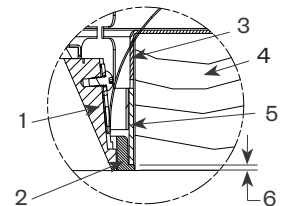

Hornet® HP

Round Lensed Downlight/Wall Wash



PROJECT:	TYPE:
-----------------	--------------

Product Details - Remodeler Trimmed

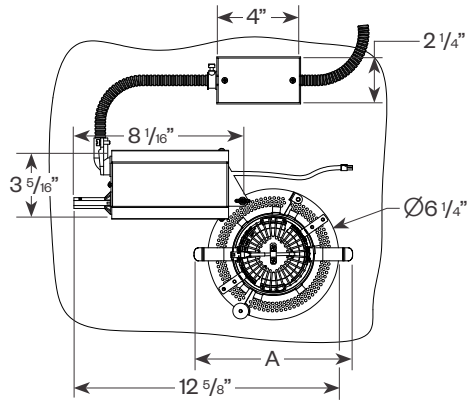

Remodeler Trimmed		
	RLD	RLW
A	7 9/16"	7"

Hornet HP Round Lensed Downlight (HDL-HP-RLD)

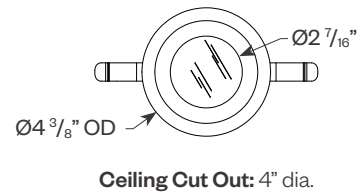
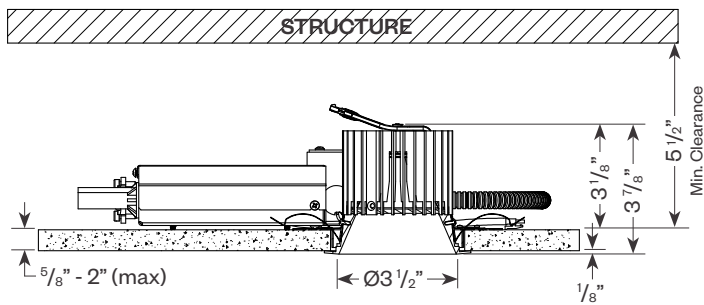

Hornet HP Round Lensed Wall Wash (HDL-HP-RLW)

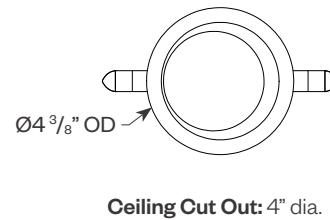
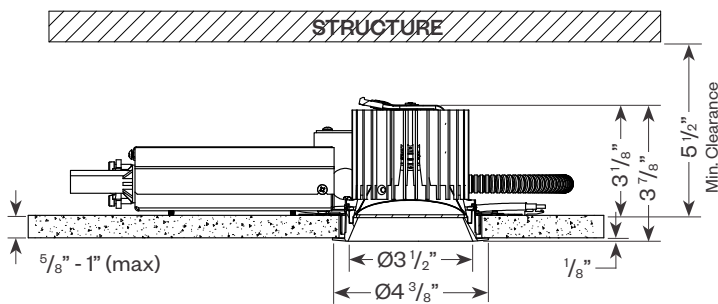

Hornet® HP

Round Lensed Downlight/Wall Wash



PROJECT:

TYPE:

Performance Data - Round Lensed Downlight (HDL-HP-RLD)

Multiplying Factors: (Multiplying Factor is based on 3000K-83 120V IES file on website)

Wattage:	9W	12W	16W	23W	27W	30W
Factor:	0.39	0.52	0.69	1.0	1.2	1.3

CCT:	2700K-83	3000K-83	3500K-83	4000K-83
Factor:	0.96	1.0	1.02	1.04

CCT:	2200K-90+	2700K-90+	3000K-90+	3500K-90+	4000K-90+	CRISP	3CLA
Factor:	0.66	0.83	0.86	0.90	0.93	0.65	0.70

23W LED, 3000K-83

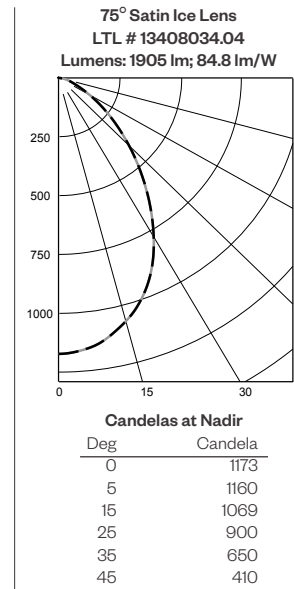
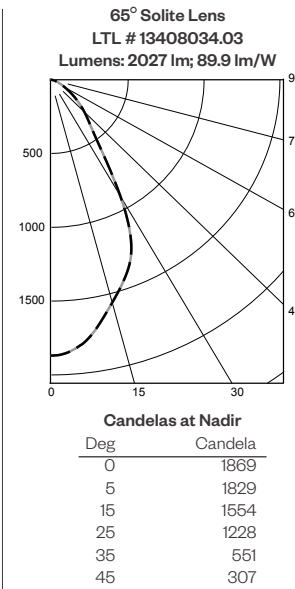
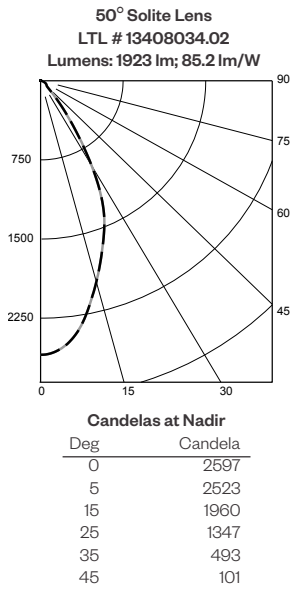
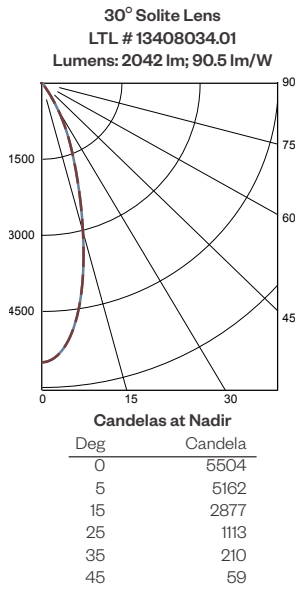

Application Data - Round Lensed Downlight (HDL-HP-RLD)

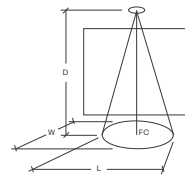

Notes and Definitions:

Beam spread is to 50% center beam candlepower (CBCP).

D=Distance to floor or wall.

FC=Footcandles on floor or wall at center beam aiming location.

L=Effective Visual Beam length in feet (50% of maximum footcandle level).

W=Effective Visual Beam width in feet (50% of maximum footcandle level).

30° Solite Lens
0° Aiming Angle
Horizontal
Footcandles

D	FC	L	W
5.0'	221	2.7	2.7
7.5'	98	3.9	3.9
10.0'	55	5.2	5.2
12.5'	36	6.5	6.5

50° Solite Lens
0° Aiming Angle
Horizontal
Footcandles

D	FC	L	W
5.0'	104	3.8	3.8
7.5'	47	5.8	5.8
10.0'	26	7.8	7.8
12.5'	17	9.7	9.7

65° Solite Lens
0° Aiming Angle
Horizontal
Footcandles

D	FC	L	W
5.0'	75	4.5	4.4
7.5'	34	6.8	6.8
10.0'	19	9.3	9.3
12.5'	13	11.8	11.8

75° Satin Ice Lens
0° Aiming Angle
Horizontal
Footcandles

D	FC	L	W
5.0'	47	5.2	5.2
7.5'	21	7.9	7.9
10.0'	12	10.7	10.7
12.5'	8	14.0	14.0

Hornet® HP

Round Lensed Downlight/Wall Wash



PROJECT:	TYPE:
-----------------	--------------

Performance Data - Round Lensed Wall Wash (HDL-HP-RLW)

Multiplying Factors: (Multiplying Factor is based on 3000K-83 120V IES file on website)

OCT:	2700K-83	3000K-83	3500K-83	4000K-83
Factor:	0.96	1.0	1.02	1.04

Wattage:	9W	12W	16W	23W	27W	30W
Factor:	0.39	0.52	0.69	1.0	1.2	1.3

OCT:	2200K-90+	2700K-90+	3000K-90+	3500K-90+	4000K-90+	CRISP	3CLA
Factor:	0.66	0.83	0.86	0.90	0.93	0.65	0.70

23W LED, 3000K-83

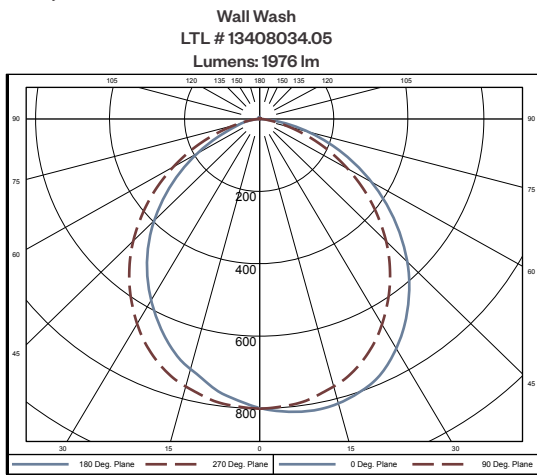

ZONAL LUMEN SUMMARY

Zone	Lumens	%Fixt
0-40	992	50.2
0-60	1665	84.3
0-90	1976	100.0
90-180	0	0.0

Luminaire Efficacy: 87.9 Lm/W

Application Data - Round Lensed Wall Wash (HDL-HP-RLW)

Footcandles on Wall

Footcandles are average and rounded off.
Data for multiple units are based on a minimum of five units.

1.5 Feet from Wall

		← 1.5' →		← 1.5' →		
Distance from ceiling	0.5'	91	95	96	95	91
	1.5'	146	155	159	156	147
	2.5'	104	113	115	113	104
	3.5'	63	70	72	70	64
	4.5'	40	43	45	44	40
	5.5'	27	29	30	30	27
	6.5'	20	21	22	21	20
	7.5'	16	16	17	17	16

1.5 Feet from Wall

		← 2' →		← 2' →		
Distance from ceiling	0.5'	37	40	37	40	36
	1.5'	72	77	75	78	72
	2.5'	69	73	74	74	69
	3.5'	48	52	54	54	49
	4.5'	33	36	37	38	33
	5.5'	23	26	27	27	24
	6.5'	17	19	20	20	18
	7.5'	14	15	16	16	14

2 Feet from Wall

		← 2' →		← 2' →		
Distance from ceiling	0.5'	39	44	42	44	41
	1.5'	83	90	90	92	83
	2.5'	77	83	85	87	77
	3.5'	55	59	62	63	55
	4.5'	38	41	43	44	38
	5.5'	27	30	31	31	28
	6.5'	21	22	23	23	21
	7.5'	16	17	18	18	16

Hornet® HP

Round Lensed Downlight/Wall Wash



PROJECT:	TYPE:
-----------------	--------------

Dimming Compatibility

Amerlux® Hornet® fixtures are compatible with all major dimming protocols prevalent in the United States. Please see below for general compatibilities and wiring diagrams. Amerlux recommends testing your unique dimming configuration as the exact full configuration (Dimmer, Fixture Quantity, Voltage, etc) may affect dimming performance.

--- NOTE: INFORMATION BELOW IS FOR WIRED DIMMERS ONLY. FOR WIRELESS DIMMERS, CONSULT FACTORY ---

TRIAC (Forward Phase) DIMMING (Standard)

Utilizes standard TRIAC dimmers that are in wide use in installations across the US. Best for retrofit applications where TRIAC dimmers are installed.

Notes:

- 120VAC or 277VAC*
- Dims down to 5% light output (most cases)
- Consult Dimming manufacturer for installation instructions - **DO NOT SHARE NEUTRALS!**
- Must meet dimmer Minimum Load Requirements per dimming manufacturer

TRIAC Wiring Diagram

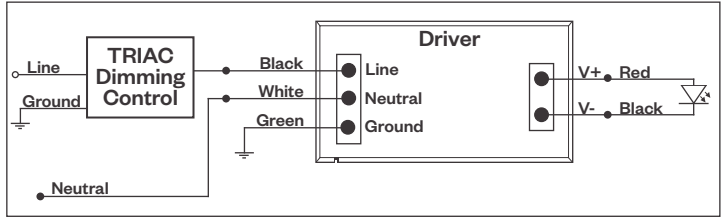

Compatible Dimmers†:	
Wall Box (TRIAC 120VAC)	Central System
Lutron "Diva"	Lutron "GP" Panel
Lutron "Nova-T"	Lutron Grafik Eye QS
Lutron "Maestro"	
Lutron "Skylark"	

ELV - Electronic Low Voltage (Reverse Phase) DIMMING (Standard)

Utilizes specialized "ELV" dimmers.

Notes:

- 120VAC or 277VAC*
- Dims down to 5% light output (most cases)
- Consult Dimming manufacturer for installation instructions - **DO NOT SHARE NEUTRALS!**
- Must meet dimmer Minimum Load Requirements per dimming manufacturer

ELV Wiring Diagram

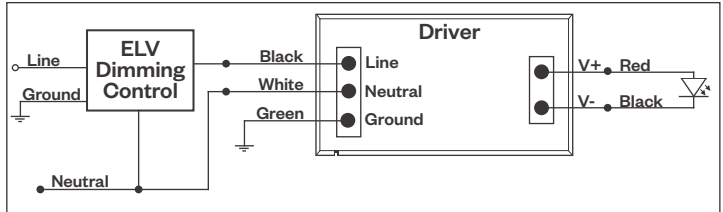

Compatible Dimmers†:		
Wall Box (ELV 120VAC)	Wall Box (ELV 277VAC)	Central System
Lutron "Diva"	Leviton Revoir II AWSMT-E	Lutron "GP" Panel with PHPM-PA 120/277VAC
Lutron "Nova-T"		Lutron Grafik Eye QS with PHPM-PA 120/277VAC
Lutron "Maestro"		
Lutron "Skylark"		
Leviton "Surslide"		
Leviton "Vizio"		

Notes:
 * Driver is 277VAC dimmable with appropriate dimmer (by others). All provided wiring diagrams show 120VAC wiring colors and method. Please refer to 277VAC dimmer installation instructions for 277VAC wiring diagrams.
 † The absence of a dimmer from the lists above does not imply incompatibility. Please consult factory for compatibility inquiries.

Hornet® HP

Round Lensed Downlight/Wall Wash



PROJECT:

TYPE:

Dimming Compatibility *(continued)*

Amerlux® Hornet® fixtures are compatible with all major dimming protocols prevalent in the United States. Please see below for general compatibilities and wiring diagrams. Amerlux recommends testing your unique dimming configuration as the exact full configuration (Dimmer, Fixture Quantity, Voltage, etc) may affect dimming performance.

--- NOTE: INFORMATION BELOW IS FOR WIRED DIMMERS ONLY. FOR WIRELESS DIMMERS, CONSULT FACTORY ---

0-10V DIMMING

Integrates into a variety of building management and daylighting controls

Notes:

- 120VAC or 277VAC*
- Dims down to 1% light output
- Requires interface to turn off power to driver
- Consult Dimming manufacturer for installation instructions - **DO NOT SHARE NEUTRALS!**

0-10V Wiring Diagram

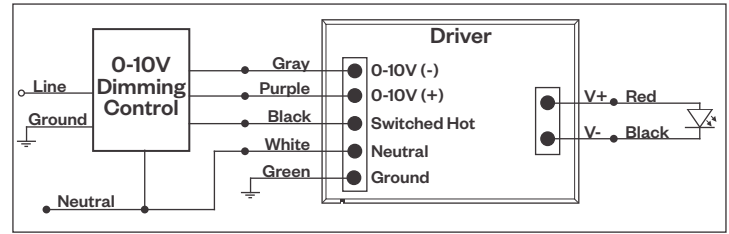

Compatible Dimmers*:

Wall Box	Central System
Lutron® "Diva" - DVSTV	Leviton Renoir II 0-10V
	Lutron Grafik Eye with GRX-TV1 Interface

LUTRON LDE1 DIMMING

Integrates into Lutron EcoSystem building management

Notes:

- 120VAC or 277VAC*
- Dims down to 1% light output
- EcoSystem Control
- Consult Dimming manufacturer for installation instructions - **DO NOT SHARE NEUTRALS!**

LDE1 (HILUME-H-ECO) EcoSystem Digital Control Wiring Diagram

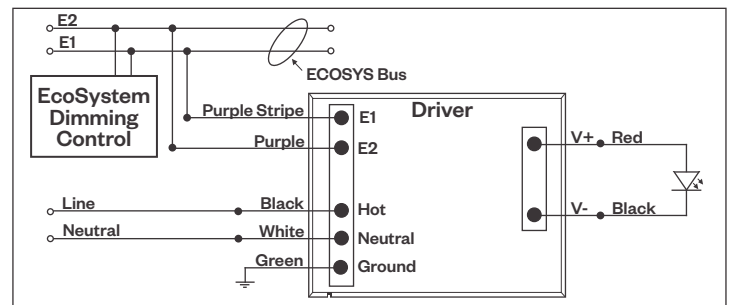

Compatible Dimmers*:

Lutron ECO System	Central System
Pow Pak Dimming Modules	Lutron EcoSystem compatible controls
Energj Savr Node	
Grafik Eye QS/Homeworks	
QS Control Unit	
Quantum Hub	
Homeworks QS/My Room	

DALI DIMMING

Digital control protocol allows individual fixture control

Notes:

- 120VAC - 277VAC*
- Dims down to 1% light output in most cases

DALI Wiring Diagram

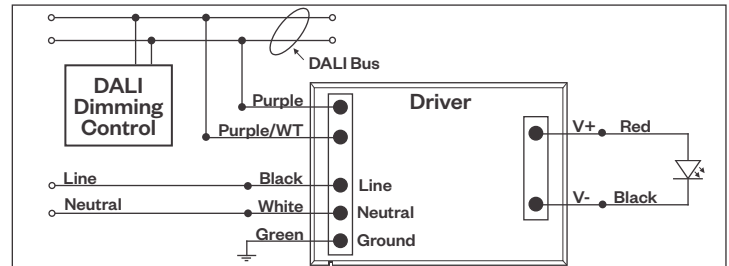

Notes:

* Driver is 277VAC dimmable with appropriate dimmer (by others). All provided wiring diagrams show 120VAC wiring colors and method. Please refer to 277VAC dimmer installation instructions for 277VAC wiring diagrams.

† The absence of a dimmer from the lists above does not imply incompatibility. Please consult factory for compatibility inquiries.

Hornet® HP

Round Lensed Downlight/Wall Wash



PROJECT:

TYPE:

Emergency Battery Pack

Wiring Diagram

