



INSTALLATION INSTRUCTIONS LINEA 1.5" DIRECT SURFACE MOUNT LED

Surface Mount for Individual Fixture or Continuous Row Mounted

689-0529
pg 1 of 2

WARNING: RISK OF FIRE AND ELECTRICAL SHOCK. FIXTURE MUST BE INSTALLED BY A QUALIFIED ELECTRICIAN ONLY. FIXTURE IS INTENDED FOR INSTALLATION IN ACCORDANCE WITH THE NATIONAL ELECTRICAL CODE, LOCAL AND FEDERAL SPECIFICATIONS. DISCONNECT POWER AT ELECTRICAL PANEL BEFORE SERVICING.

RETAIN THESE INSTRUCTIONS FOR MAINTENANCE REFERENCE.

Pre-Installation Note:

- Supplied by others: feed conduits
- Supplied by Amerlux: pre-drilled mounting points at 6" from ends of fixture

Suggested Suspension Points:

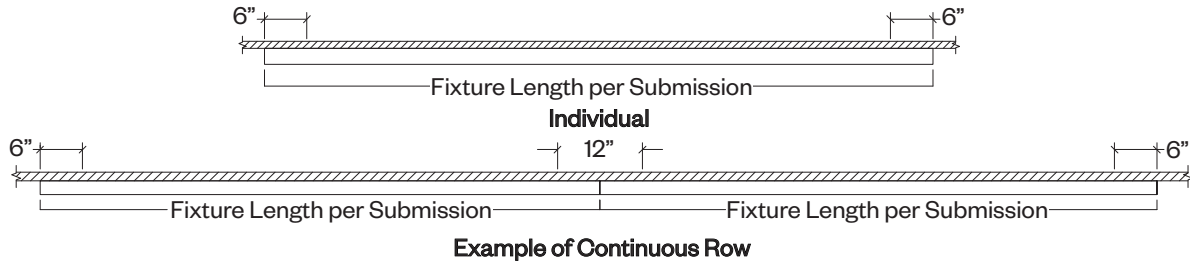

Refer to general contractor/electrician layout for proper location of mounting points/locations for feed conduits.

1. Install feed conduit(s) - Make sure fixture can sit flush with ceiling.

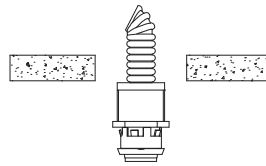

2. Individual and Beginning of Run (BOR) Install*:

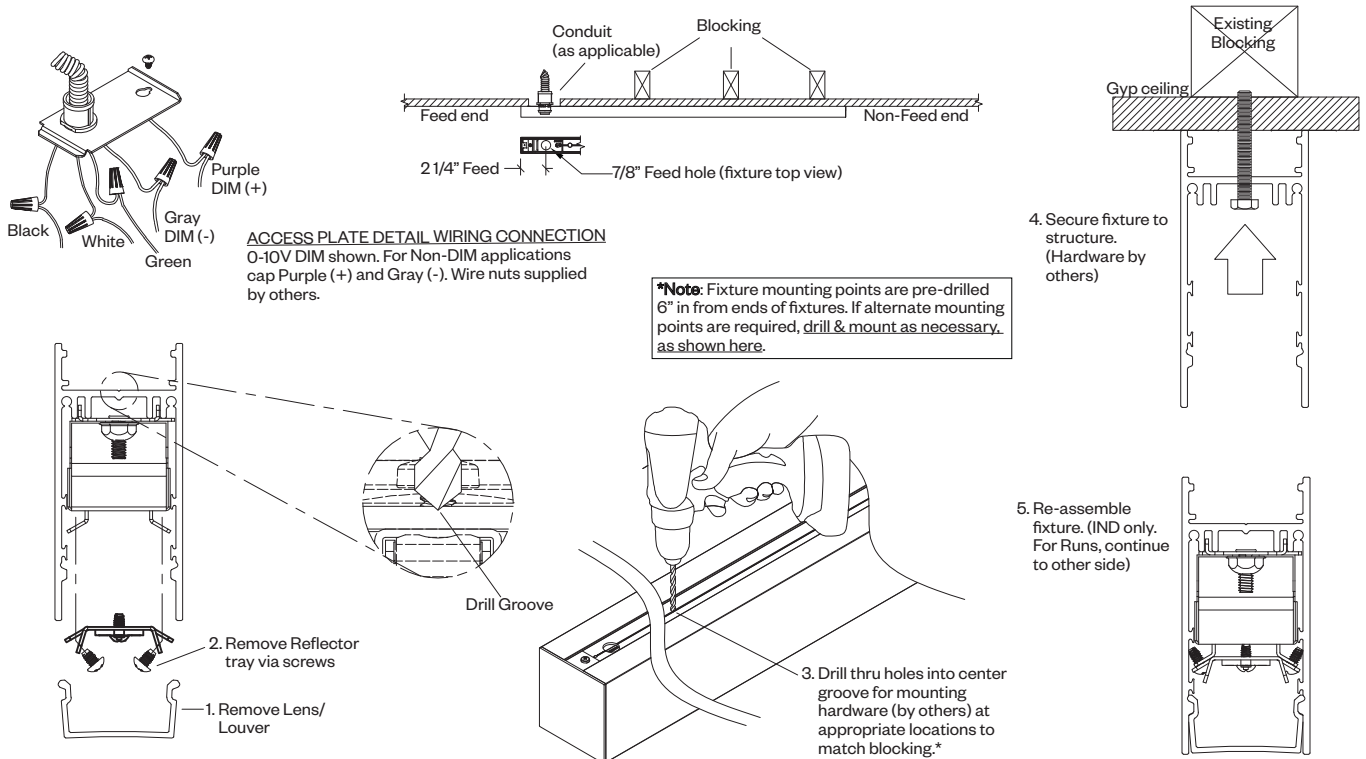



INSTALLATION INSTRUCTIONS
 LINEA 1.5" DIRECT SURFACE MOUNT
 LED

Surface Mount for Individual Fixture or Continuous Row Mounted

689-0529
 pg 2 of 2

3. Hang Continuing Fixtures - After the BOR has been installed:

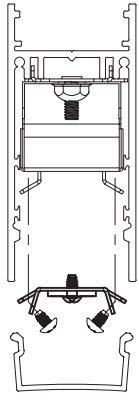

A. Prep Fixture for Mounting -
 Remove reflector tray assembly & drill holes in appropriate mounting locations, if necessary (per contractor)*

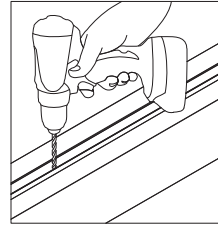

B. Join Fixtures Together -
 Use the aligning pins to engage and secure with Catch/Latch. Then secure to ceiling via mounting hardware (by others).

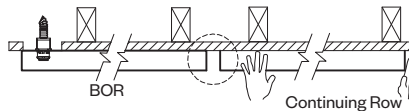
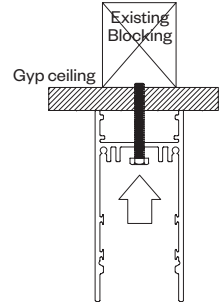
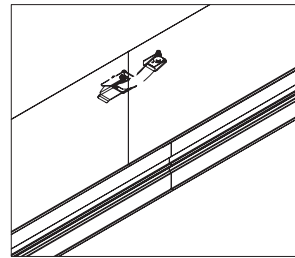
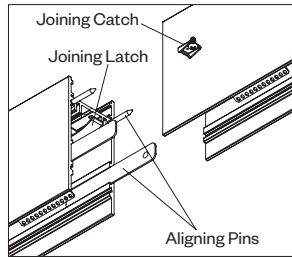

C. Re-Assembly and Power -
 Install BOR reflector tray and connect power. Moving down the line (see working direction), connect the next tray to power and install. Repeat until End of Run.

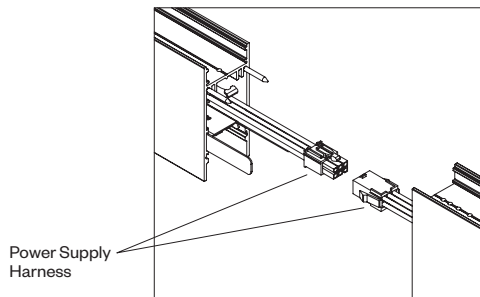
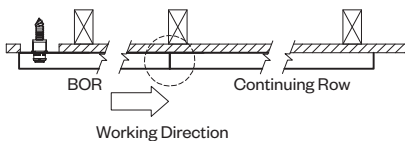

Re-Assembled Section View

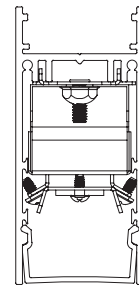

MAKE SURE TO DISCONNECT ALL ELECTRICAL CONNECTIONS BEFORE RE-LAMPING.

WARNING: Electrostatic and polarity sensitive device. Use caution while handling and wiring.

1.) LED Fixture:
 Consult Amerlux for LED maintenance.

2.) LED Replacement:
 For LED board replacement reference 689-0500 Instruction Sheet.

3.) Driver maintenance:
 Drivers are located on tray beneath direct reflectors, (1) driver per tray, secured by (2) #8 pal nuts. Remove the reflector mounting screws to access. For programmable driver replacement please specify: **Manufacturer, Model No. and Current Setting (___ mA)**. For drivers with **external** resistors, keep driver resistor value during driver maintenance or replacement.

See 710-0134 Wiring Schematic for more details.

