

Solace

3" Shallow Square Lens Wall Wash



Lens Wall Wash

Features

Solace 3" Downlights are the complete downlight family for any ceiling surface and low plenum ceiling. Round or Square apertures, available as downlight, adjustable or wallwash. Optional Solite lensing provides whisper quiet aesthetics. The trim options available as trimmed, trimless or millwork. The pinhole and shower pinhole trim makes this a complete a downlight to design the entire space with the same look.

Product Overview

Type:	Shallow Square Lens Wall Wash
Wattage:	8, 12, 17
Max Lumen Output:	1082 lm; 63.6 lm/W
CBCP:	600 max
Color Temp:	2700K, 3000K, 3500K, 4000K
CRI:	83 typ. 90+ typ. CrispWhite & 3K Class A available
Dimming:	TRIAC & ELV - 5% Dim 0-10V - 1% Dim Lutron [†] Hi-lume EcoSystem Premier 0.1% dim with soft on & fade to black

† Consult factory for Lutron lead time

PROJECT:

TYPE:



Lens Wall Wash Trimless

Fixture Type

Round/Square	New Construction	Trimmed	Trimless	Millwork
Yes	Yes	Yes	Yes	Yes

See separate spec sheet for Round trim fixture

Performance Chart (see page 5 for full breakdown)

Watts	Delivered Lumens	LPW	CBCP	Color Temp
8	573	68	318	3000K-83
12	844	68	468	3000K-83
17	1082	64	600	3000K-83

Data is based on 3000K-83 IES files available on website.

Electrical Data

	8W		12W		17W	
	System Watts	Amps	System Watts	Amps	System Watts	Amps
120V	8	0.067	12	0.10	17	0.142
277V	8	0.029	12	0.043	17	0.061

Electronic constant current LED driver



Solace Square Lens Wall Wash

3" Shallow Square Lens Wall Wash



PROJECT:

TYPE:

Housing/Frame Ordering Information

1	2	3	4	5	6	7
<p>1 <u>Model</u> SOL-SLW-NC (New Construction & Insulated Ceiling (IC rated)) SOL-SLW-CP (Chicago Plenum (CCEA) housing) SOL-SLW-IC (Insulated Ceiling (IC rated) & Air Tight)</p>	<p>2 <u>Style</u> T - trimmed, 2" max ceiling thickness TL - trimless, 5/8" max ceiling thickness MWK - millwork (for 1/2" - 11/16" ceiling thickness) MWK1 - millwork (for 3/4" - 1-1/2" ceiling thickness) MWK2 - millwork (for 1-1/2" - 2" ceiling thickness)</p>	<p>3 <u>Wattage</u> (3000K-83, See pg 5 for performance table) 8 (573 lm) 12 (844 lm) 17 (1082 lm)</p>	<p>4 <u>Voltage</u> 120/277 - universal voltage</p>	<p>5 <u>Color Temp</u> 83 CRI <u>90+ CRI</u> 27 - 2700K-83 279 - 2700K-90+ CRISP* - CrispWhite 30 - 3000K-83 309 - 3000K-90+ 3CLA* - 3K Class A 35 - 3500K-83 359 - 3500K-90+ 40* - 4000K-83 409* - 4000K-90+ * Consult factory for lead time</p>	<p>6 <u>Driver</u> (for non-dimming, select LE/TE option) LE/TE - TRIAC/ELV, 5% dim O-10V - 0-10V, 1% dim HILUME-P-ECO* - Lutron Hi-lume EcoSystem Premier 0.1% dim with soft on & fade to black + Consult factory for Lutron lead time</p>	<p>7 <u>Options</u> HB49 - hanger bars from min 29" to max 49" (26" hanger bars included as default option)</p>

Trim Ordering Information

1	2	3												
<p>1 <u>Model</u> SOL-SLW (wall wash)</p>	<p>2 <u>Style</u> T - trimmed TL - trimless MWK - millwork</p>	<p>3 <u>Finish</u></p> <table border="0"> <tr> <td><u>Trimmed</u></td> <td><u>Trimless/Millwork</u></td> </tr> <tr> <td>MBW - matte black, white flange</td> <td>MB - matte black</td> </tr> <tr> <td>MWW - matte white, white flange</td> <td>MW - matte white</td> </tr> <tr> <td>SLVW - matte silver, white flange</td> <td>SLV - matte silver</td> </tr> <tr> <td>MBB - matte black, black flange</td> <td></td> </tr> <tr> <td>SLVS - matte silver, silver flange</td> <td></td> </tr> </table>	<u>Trimmed</u>	<u>Trimless/Millwork</u>	MBW - matte black, white flange	MB - matte black	MWW - matte white, white flange	MW - matte white	SLVW - matte silver, white flange	SLV - matte silver	MBB - matte black, black flange		SLVS - matte silver, silver flange	
<u>Trimmed</u>	<u>Trimless/Millwork</u>													
MBW - matte black, white flange	MB - matte black													
MWW - matte white, white flange	MW - matte white													
SLVW - matte silver, white flange	SLV - matte silver													
MBB - matte black, black flange														
SLVS - matte silver, silver flange														

Solace Square Lens Wall Wash

3" Shallow Square Lens Wall Wash



PROJECT:

TYPE:

Specifications

Application

Retail and commercial wall wash lighting

Housing Construction

20 ga. steel painted matte black
Extruded aluminum heatsink
Formed aperture plate with 5/8" lip (GB-standard)
Cast aluminum plaster frame with perforated face (for trimless option)
Integral adjustable locking mounting bars inherently protected

Reflector Trim Construction

Die-cast reflector
Injection molded optic lens

LED

Color Temp Options: 2700K, 3000K, 3500K, 4000K
CRI: 83 typ. (2700K, 3000K, 3500K, 4000K)
90+ typ. (2700K, 3000K, 3500K, 4000K)
CrispWhite* & Class A** 3000K (high gamut) available
R9 Values: 11 (83 CRI), 55 (92 CRI)
Binning: 3 MacAdam (SDCM)
Life: 50,000+ hrs, > 70% of initial lumens at 50,000 hrs

**CrispWhite: CrispWhite Technology delivers the warmth of colors expected from a high 90 CRI solution but also creates the natural crisp white color that is pleasing to the eye. It creates the most impactful lighting ever available, by revealing the richest whites and vibrant colors that pop.*

***Class A LED: Class A LED's have a CRI > 80 and a GAI > 80. CRI defines color "Naturalness" and GAI defines color "Saturation." Both being high delivers rich colors and pure whites.*

Electrical

Wattage: 8, 12, 17
Electronic constant current LED driver, 120/277VAC input
This product complies with IEEE C62.41 for surge endurance up to 2.5KV. Amerlux® recommends using additional surge protection with this unit (supplied by others), surge and over voltage damage is not covered under warranty.
Emergency option available through circuiting/inverter only

Drivers

LE/TE - Leading Edge, TRIAC, forward phase/Trailing Edge, ELV, reverse phase (standard)
0-10V and Lutron systems also available
See pages 7-8 for more dimming information

Finish (Trim)

Powder coat paint

Mounting

26" Hanger bars included. Side brackets allow for rigid conduit pipe mounting along with additional 1/2" adjustment of housing vertical position
Optional **HB49** - hanger bars from min 29" to max 49" available

Trimmed Fixture:

For use in grid or sheetrock ceilings, 5/8" - 2" standard

Note: Ceiling thickness greater than 1" will affect beam pattern

Trimless Fixture:

For use in sheetrock ceilings, max ceiling thickness 5/8"
For sheetrock ceilings beyond 5/8" consult factory

Millwork Fixture:

Millwork extension collars are based on ceiling material specifications and thickness. Provides flush trim appearance level with ceiling material. Max thickness 2"

Certifications

CSA damp as tested to UL 1598 standards
IC/AT rated

Warranty

5 year limited warranty

Weight

Housing and trim - 5 lbs.

Solace Square Lens Wall Wash

3" Shallow Square Lens Wall Wash



PROJECT:

TYPE:

Solace Square Lens Wall Wash

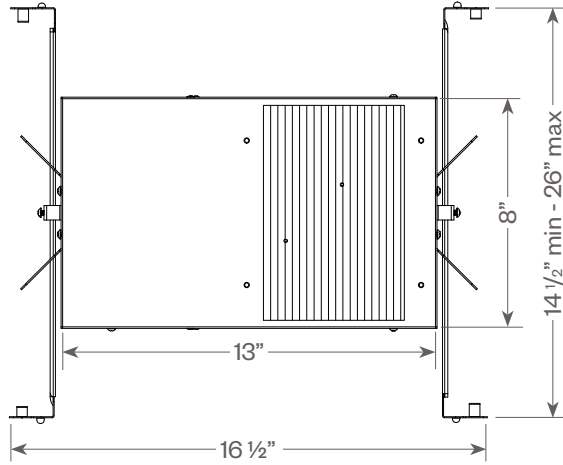

Plaster Frame Installation Detail (for trimless fixture only)

1. Reflector Trim
2. Aperture plate
3. Ceiling 5/8"
4. Cast Aluminum Plaster Frame
5. Plaster Skim Coat (by others)
6. 6-32 Type F Thread Cutting Screw

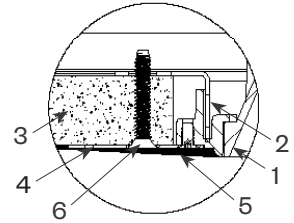

Millwork Detail

1. Reflector Trim
2. Millwork Ring
3. Aperture Plate
4. Wood Ceiling 2" Max
5. Extension collar (see ordering information for ceiling thicknesses)
6. 1/16" required for trim to be flush with ceiling

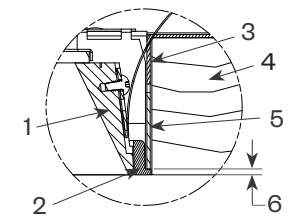

Square Lens Wall Wash

Trimmed

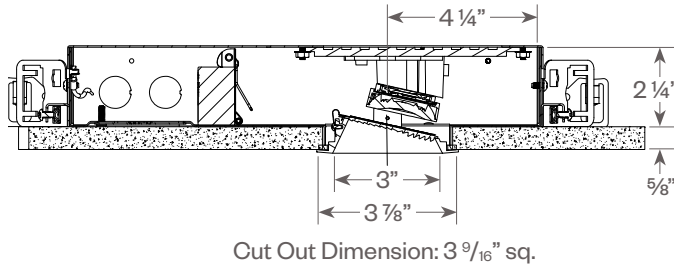

Trimless & Millwork

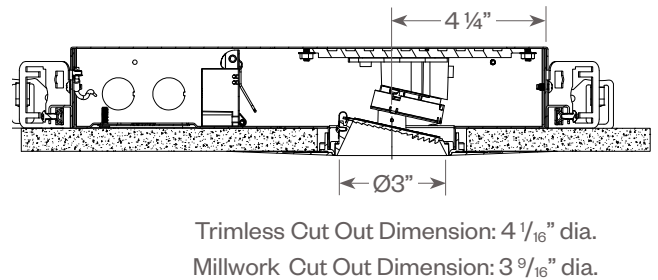

Solace Square Lens Wall Wash

3" Shallow Square Lens Wall Wash



PROJECT:

TYPE:

Solace Round Downlights Performance Breakdown

Wattage	Color Temp	Wall Wash	
		Lumens	LPW
8W	27	562	67
	30	573	68
	35	585	70
	40	602	72
	279	482	57
	309	499	59
	359	516	61
	409	516	61
	CRISP	373	44
	3CLA	401	48
12W	27	827	66
	30	844	68
	35	861	69
	40	886	71
	279	709	57
	309	734	59
	359	760	61
	409	760	61
	CRISP	549	44
	3CLA	591	47
17W	27	1060	62
	30	1082	64
	35	1104	65
	40	1136	67
	279	909	53
	309	941	55
	359	974	57
	409	974	57
	CRISP	703	41
	3CLA	757	45

Solace Square Lens Wall Wash

3" Shallow Square Lens Wall Wash



PROJECT:

TYPE:

FIXTURE DATA: (Complete photometric data (.ies format) available upon request)

MULTIPLYING FACTORS: (Multiplying Factor is based on 3000K-83 120V IES file on website)

Wattage:	8W	12W	17W
Factor:	0.53	0.78	1.0

CCT:	2700K-83	3000K-83	3500K-83	4000K-83
Factor:	0.98	1.0	1.02	1.05

CCT:	2700K-90+	3000K-90+	3500K-90+	4000K-90+	CRISP	3CLA
Factor:	0.84	0.87	0.90	0.90	0.65	0.70

Solace Square Lens Wall Wash (SOL-SLW) - 17W, 3000K-83

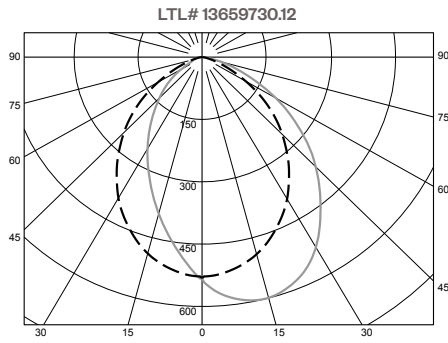

ZONAL LUMEN SUMMARY

Zone	Lumens	%Fixt
0-40	604	55.8
0-60	960	88.7
0-90	1082	100.0
90-180	0	0.00

Luminaire Efficacy: 63.6 Lm/W

Application Data:

Footcandles on Wall

Footcandles are average and rounded off.
Data for multiple units are based on a minimum of five units.

1.5 Feet from Wall

Distance from ceiling	0.5'	1.5'	2.5'	3.5'	4.5'	5.5'	6.5'	7.5'
0.5'	40	47	49	49	49	47	40	
1.5'	76	92	98	99	98	93	76	
2.5'	57	70	76	78	76	71	57	
3.5'	36	43	48	49	48	44	37	
4.5'	23	27	30	31	30	27	23	
5.5'	16	18	20	21	20	18	16	
6.5'	12	13	14	15	14	13	12	
7.5'	9	10	11	11	11	10	9	

1.5 Feet from Wall

Distance from ceiling	0.5'	1.5'	2.5'	3.5'	4.5'	5.5'	6.5'	7.5'
0.5'	35	36	39	36	39	36	39	35
1.5'	65	71	76	74	77	74	75	64
2.5'	47	55	59	60	61	60	59	48
3.5'	30	35	38	39	40	39	38	30
4.5'	19	22	24	25	26	26	25	20
5.5'	13	15	17	18	18	17	16	14
6.5'	10	11	12	13	13	13	12	10
7.5'	8	9	10	10	10	10	9	8

2 Feet from Wall

Distance from ceiling	0.5'	1.5'	2.5'	3.5'	4.5'	5.5'	6.5'	7.5'
0.5'	17	19	21	20	21	20	20	18
1.5'	43	50	53	53	54	54	53	43
2.5'	42	50	54	56	56	56	55	43
3.5'	31	37	40	42	42	42	40	31
4.5'	22	26	28	29	30	29	28	22
5.5'	16	18	20	21	21	21	20	16
6.5'	12	14	15	16	16	16	15	12
7.5'	10	11	11	12	12	12	11	10

Solace Square Lens Wall Wash

3" Shallow Square Lens Wall Wash



PROJECT:

TYPE:

DIMMING COMPATIBILITY:

Amerlux® Solace fixtures are compatible with all major dimming protocols prevalent in the United States. Please see below for general compatibilities and wiring diagrams. Amerlux recommends testing your unique dimming configuration as the exact full configuration (Dimmer, Fixture Quantity, Voltage, etc) may affect dimming performance.

--- NOTE: INFORMATION BELOW IS FOR WIRED DIMMERS ONLY. FOR WIRELESS DIMMERS, CONSULT FACTORY ---

TRIAC (Forward Phase) DIMMING (Standard)

Utilizes standard TRIAC dimmers that are in wide use in installations across the US. Best for retrofit applications where TRIAC dimmers are installed.

Notes:

- 120VAC or 277VAC*
- Dims down to 5% light output (most cases)
- Consult Dimming manufacturer for installation instructions - DO NOT SHARE NEUTRALS!
- Must meet dimmer Minimum Load Requirements per dimming manufacturer

TRIAC Wiring Diagram

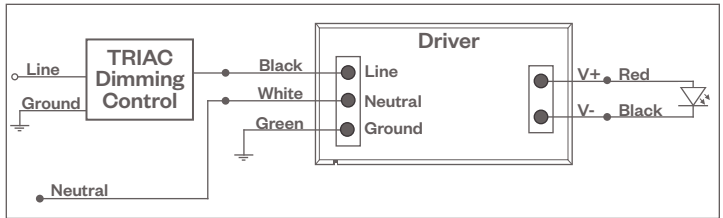

Compatible Dimmers†:

Wall Box (TRIAC 120VAC)	Central System
Lutron "Diva"	Lutron "GP" Panel
Lutron "Nova-T"	Lutron Grafik Eye QS
Lutron "Maestro"	
Lutron "Vareo"	
Lutron "Skylark"	

ELV - Electronic Low Voltage (Reverse Phase) DIMMING (Standard)

Utilizes specialized "ELV" dimmers.

Notes:

- 120VAC or 277VAC*
- Dims down to 5% light output (most cases)
- Consult Dimming manufacturer for installation instructions - DO NOT SHARE NEUTRALS!
- Must meet dimmer Minimum Load Requirements

ELV Wiring Diagram

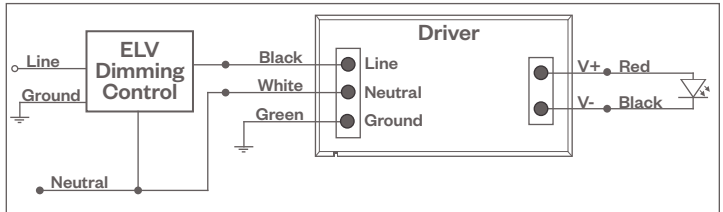

Compatible Dimmers†:

Wall Box (ELV 120VAC)	Wall Box (ELV 277VAC)	Central System
Lutron "Diva"	Leviton Revoir II AWSMT-E	Lutron "GP" Panel with PHPM-PA 120/277VAC
Lutron "Nova-T"		Lutron Grafik Eye QS with PHPM-PA 120/277VAC
Lutron "Maestro"		
Lutron "Vareo"		
Lutron "Skylark"		
Leviton "Surslide"		
Leviton "Vizio"		

Notes:

- * Driver is 277VAC dimmable with appropriate dimmer (by others). All provided wiring diagrams show 120VAC wiring colors and method. Please refer to 277VAC dimmer manufacturer installation instructions for 277VAC wiring diagrams.
- † The absence of a dimmer from the lists above does not imply incompatibility. Please consult factory for compatibility inquiries.

Solace Square Lens Wall Wash

3" Shallow Square Lens Wall Wash



PROJECT:

TYPE:

DIMMING COMPATIBILITY:

Amerlux® Solace fixtures are compatible with all major dimming protocols prevalent in the United States. Please see below for general compatibilities and wiring diagrams. Amerlux recommends testing your unique dimming configuration as the exact full configuration (Dimmer, Fixture Quantity, Voltage, etc) may affect dimming performance.

--- NOTE: INFORMATION BELOW IS FOR WIRED DIMMERS ONLY. FOR WIRELESS DIMMERS, CONSULT FACTORY ---

0-10V DIMMING

Integrates into a variety of building management and daylighting controls

Notes:

- 120VAC or 277VAC*
- Dims down to 1% light output
- Requires interface to turn off power to driver
- Consult Dimming manufacturer for installation instructions - DO NOT SHARE NEUTRALS!

0-10V Wiring Diagram

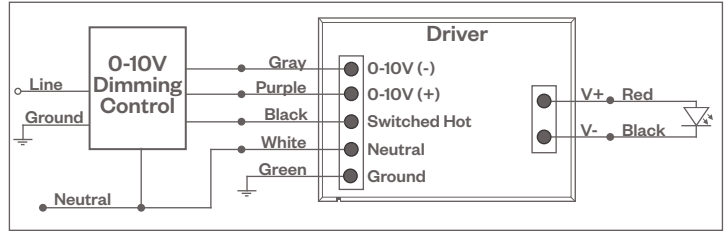

Compatible Dimmers*:

Wall Box

Lutron "Diva" - DTVV with PP-120H Interface

Leviton Renoir II 0-10V

Central System

Lutron Grafik Eye with GRX-TV1 Interface

LUTRON ECOSYSTEM DIMMING

Integrates into Lutron EcoSystem building management

Notes:

- 120VAC or 277VAC*
- Dims down to 0.1% light output
- EcoSystem Control
- Consult Dimming manufacturer for installation instructions - DO NOT SHARE NEUTRALS!

HILUME-P-ECO

EcoSystem Digital Control Wiring Diagram

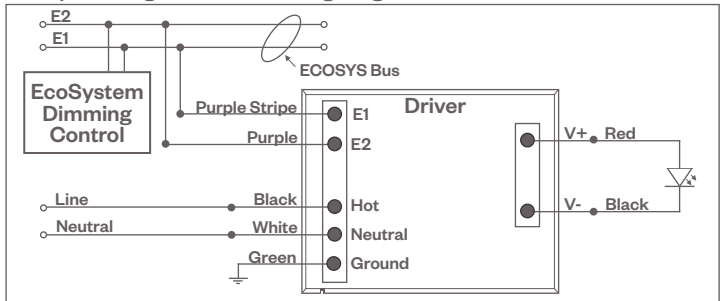

Compatible Dimmers*:

Lutron ECO System

Pow Pak Dimming Modules
 Energi Savr Node
 Grafik Eye QS/Homeworks
 QS Control Unit
 Quantum Hub
 Homeworks QS/My Room

Central System

Lutron EcoSystem compatible controls

Notes:

- * Driver is 277VAC dimmable with appropriate dimmer (by others). All provided wiring diagrams show 120VAC wiring colors and method. Please refer to 277VAC dimmer manufacturer installation instructions for 277VAC wiring diagrams.
- † The absence of a dimmer from the lists above does not imply incompatibility. Please consult factory for compatibility inquiries.