

# Solace

## 3" Shallow Square Adjustables



### Features

Solace 3" Downlights are the complete downlight family for any ceiling surface and low plenum ceiling. Round or Square apertures, available as downlight, adjustable or wallwash. Optional Solite lensing provides whisper quiet aesthetics. The trim options available as trimmed, trimless or millwork. The pinhole and shower pinhole trim makes this a complete a downlight to design the entire space with the same look.

### Product Overview

Type:	Shallow Square Adjustable
Wattage:	8, 12, 17
Max Lumen Output:	1584 lm; 93.9 lm/W (Flood optics)
CBCP:	7218 (Flood optics)
Color Temp:	2700K, 3000K, 3500K, 4000K
CRI:	83 typ. 90+ typ. CrispWhite & 3K Class A available
Dimming:	TRIAC & ELV - 5% Dim 0-10V - 1% Dim Lutron <sup>†</sup> Hi-lume EcoSystem Premier 0.1% dim with soft on & fade to black

**† Consult factory for Lutron lead time**

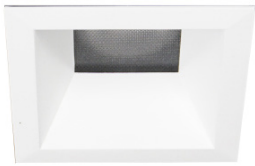

Adjustable  
(shown with Solite lens)



Adjustable Trimless

### PROJECT:

### TYPE:



Pinhole Adjustable



Pinhole Adjustable  
Trimless



Pinhole Adjustable Shower

### Fixture Type

Round/Square	New Construction	Trimmed	Trimless	Millwork
Yes	Yes	Yes	Yes	Yes

See separate spec sheet for Round trim fixture

### Performance Chart (see page 5 for full breakdown)

Watts	Delivered Lumens	LPW	CBCP	Color Temp
8	840	100	3826	3000K-83
12	1236	99	5630	3000K-83
17	1584	94	7218	3000K-83

Data is based on 3000K-83 IES files available on website.

Data is Flood optic (no Solite). See page 6-8 for other beam spreads.

### Electrical Data

	8W		12W		17W	
	System Watts	Amps	System Watts	Amps	System Watts	Amps
120V	8	0.067	12	0.10	17	0.142
277V	8	0.029	12	0.043	17	0.061

Electronic constant current LED driver



# Solace Square Adjustables

3" Shallow Square Adjustables



## PROJECT:

## TYPE:

### Housing/Frame Ordering Information

1	2	3	4	5	6	7	8
<p><b>1</b> <u>Model</u>  <b>SOL-SA-NC</b> (New Construction &amp; Insulated Ceiling (IC rated))  <b>SOL-SA-CP</b> (Chicago Plenum (CCEA) housing)  <b>SOL-SA-IC</b> (Insulated Ceiling (IC rated) &amp; Air Tight)</p>	<p><b>2</b> <u>Style</u>  <b>T</b> - trimmed, 2" max ceiling thickness  <b>TL</b> - trimless, 5/8" max ceiling thickness  <b>MWK</b> - millwork (for 1/2" - 11/16" ceiling thickness)  <b>MWK1</b> - millwork (for 3/4" - 1-1/2" ceiling thickness)  <b>MWK2</b> - millwork (for 1-1/2" - 2" ceiling thickness)</p>	<p><b>3</b> <u>Wattage</u> (3000K-83, FL beam. See pg 5 for performance table)  <b>8</b> (840 lm)  <b>12</b> (1236 lm)  <b>17</b> (1584 lm)</p>	<p><b>4</b> <u>Voltage</u>  <b>120/277</b> - universal voltage</p>	<p><b>5</b> <u>Beam Spreads</u>  <b>SP</b> - spot, 15°  <b>FL</b> - flood, 25°  <b>WF</b> - wide flood, 36°  <b>VWF</b> - very wide flood, 55°</p>	<p><b>6</b> <u>Color Temp</u>  <b>83 CRI</b>  <b>27</b> - 2700K-83    <b>279</b> - 2700K-90+    <b>CRISP*</b> - CrispWhite  <b>30</b> - 3000K-83    <b>309</b> - 3000K-90+    <b>3CLA*</b> - 3K Class A  <b>35</b> - 3500K-83    <b>359</b> - 3500K-90+  <b>40*</b> - 4000K-83    <b>409*</b> - 4000K-90+  * Consult factory for lead time</p>	<p><b>7</b> <u>Driver</u> (for non-dimming, select LE/TE option)  <b>LE/TE</b> - TRIAC/ELV, 5% dim  <b>0-10V</b> - 0-10V, 1% dim  <b>HILUME-P-ECO*</b> - Lutron Hi-lume EcoSystem Premier 0.1% dim with soft on &amp; fade to black  * Consult factory for Lutron lead time</p>	<p><b>8</b> <u>Options</u>  <b>HB49</b> - hanger bars from min 29" to max 49" (26" hanger bars included as default option)</p>

### Trim Ordering Information

1	2	3	4
<p><b>1</b> <u>Model</u>  <b>SOL-SA</b> (adjustable)  <b>SOL-SPA</b> (pinhole adjustable)  <b>SOL-SPASHW</b> (pinhole adjustable shower)</p>	<p><b>2</b> <u>Style</u>  <b>T</b> - trimmed  <b>TL</b> - trimless (not available for use with shower trims)  <b>MWK</b> - millwork (not available for use with shower trims)</p>	<p><b>3</b> <u>Finish - SA trim</u>  <u>Trimmed</u>  <b>MBW</b> - matte black, white flange  <b>MWW</b> - matte white, white flange  <b>SLVW</b> - matte silver, white flange  <b>MBB</b> - matte black, black flange  <b>SLVS</b> - matte silver, silver flange  <u>Finish - SPA/SPASHW trims (Trimmed/Trimless/Millwork)</u>  <b>MB</b> - matte black  <b>MW</b> - matte white  <b>SLV</b> - matte silver</p>	<p><b>4</b> <u>Options/Accessories</u>  <b>SOL</b> - solite beam softening lens (comes standard with SPASHW trim)</p>

# Solace Square Adjustables

3" Shallow Square Adjustables



## PROJECT:

## TYPE:

### Specifications

#### Application

Retail and commercial accent and display lighting

#### Housing Construction

20 ga. steel painted matte black  
Extruded aluminum heatsink  
Formed aperture plate with 5/8" lip (GB-standard)  
Cast aluminum plaster frame with perforated face (for trimless option)  
Integral adjustable locking mounting bars  
Inherently protected

#### Reflector Trim Construction

Die-cast reflector  
Pinhole Trim features stamped faceplate and die cast baffle  
Pinhole Adjustable Shower trim features solite glass lens and silicone flange gasket

#### Optical

0-40 deg lockable tilt, 360° lockable rotation, and lockable aiming (ceiling thickness greater than 1" will affect max angle adjustment)  
Beam spreads: Spot, 15°; Flood, 25°; Wide Flood, 36°; Very Wide Flood, 55°  
Optional **SOL** - solite beam softening lens (up to ~5° widening of beam)

#### LED

Color Temp Options: 2700K, 3000K, 3500K, 4000K  
CRI: 83 typ. (2700K, 3000K, 3500K, 4000K)  
90+ typ. (2700K, 3000K, 3500K, 4000K)  
CrispWhite\* & Class A\*\* 3000K (high gamut) available  
R9 Values: 11 (83 CRI), 55 (92 CRI)  
Binning: 3 MacAdam (SDCM)  
Life: 50,000+ hrs, > 70% of initial lumens at 50,000 hrs

*\*CrispWhite: CrispWhite Technology delivers the warmth of colors expected from a high 90 CRI solution but also creates the natural crisp white color that is pleasing to the eye. It creates the most impactful lighting ever available, by revealing the richest whites and vibrant colors that pop.*

*\*\*Class A LED: Class A LED's have a CRI > 80 and a GAI > 80. CRI defines color "Naturalness" and GAI defines color "Saturation." Both being high delivers rich colors and pure whites.*

#### Electrical

Wattage: 8, 12, 17  
Electronic constant current LED driver, 120/277VAC input  
**This product complies with IEEE C62.41 for surge endurance up to 2.5KV. Amerlux® recommends using additional surge protection with this unit (supplied by others), surge and over voltage damage is not covered under warranty.**  
Emergency option available through circuiting/inverter only

#### Drivers

LE/TE - Leading Edge, TRIAC, forward phase/Trailing Edge, ELV, reverse phase (standard)  
0-10V and Lutron systems also available  
See pages 9-10 for more dimming information

#### Finish (Trim)

Powder coat paint

#### Mounting

26" Hanger bars included. Side brackets allow for rigid conduit pipe mounting along with additional 1/2" adjustment of housing vertical position  
Optional **HB49** - hanger bars from min 29" to max 49" available  
**Trimmed Fixture:**  
For use in grid or sheetrock ceilings, 5/8" - 2" standard  
**Note: Ceiling thickness greater than 1" will affect max angle adjustment**  
**Trimless Fixture (not available with Shower trim):**  
For use in sheetrock ceilings, max ceiling thickness 5/8"  
For sheetrock ceilings beyond 5/8" consult factory

#### Millwork Fixture:

Millwork extension collars are based on ceiling material specifications and thickness. Provides flush trim appearance level with ceiling material. Max thickness 2".

**Note: Ceiling thickness greater than 1" will affect max angle adjustment**

#### Certifications

CSA damp as tested to UL 1598 standards  
Wet location (SHW trim) - for indoor, high humidity/moisture from below applications only  
IC/AT rated

#### Warranty

5 year limited warranty

#### Weight

Housing and trim - 7 lbs.

# Solace Square Adjustables

3" Shallow Square Adjustables



**PROJECT:**

**TYPE:**

**Solace Square Adjustables**

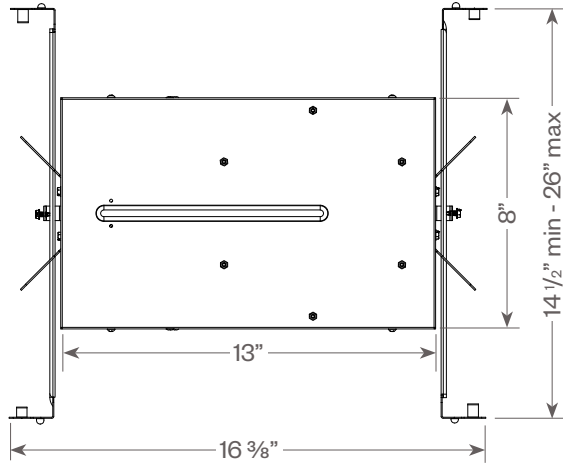

**Plaster Frame Installation Detail** (for trimless fixture only)

1. Reflector Trim
2. Aperture plate
3. Ceiling 5/8"
4. Cast Aluminum Plaster Frame
5. Plaster Skim Coat (by others)
6. 6-32 Type F Thread Cutting Screw

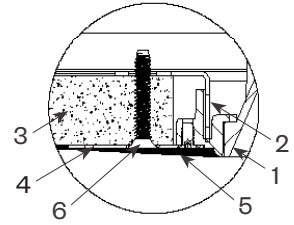

**Millwork Detail**

1. Reflector Trim
2. Millwork Ring
3. Aperture Plate
4. Wood Ceiling 2" Max
5. Extension collar (see ordering information for ceiling thicknesses)
6. 1/16" required for trim to be flush with ceiling

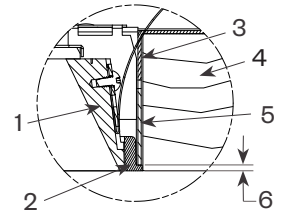

**Square Adjustable Trimmed**

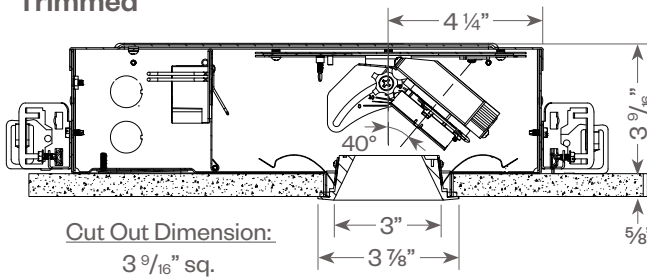

**Trimless and Millwork**

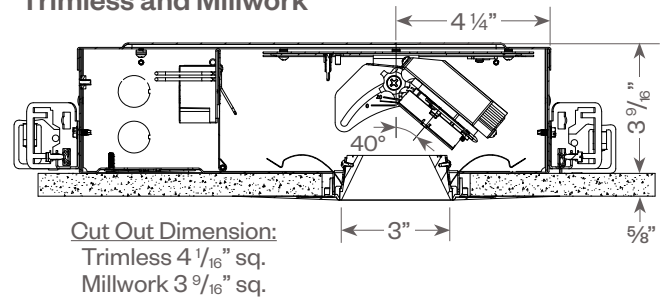

**Square Pinhole Adjustable Trimmed**

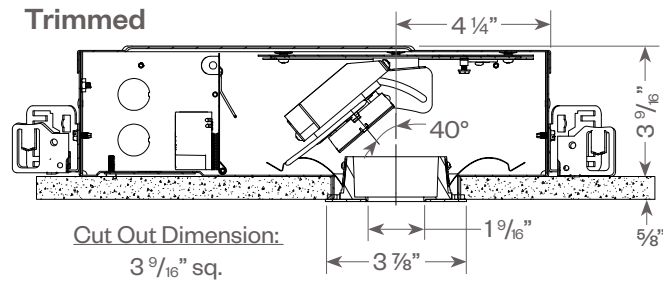

**Trimless and Millwork**

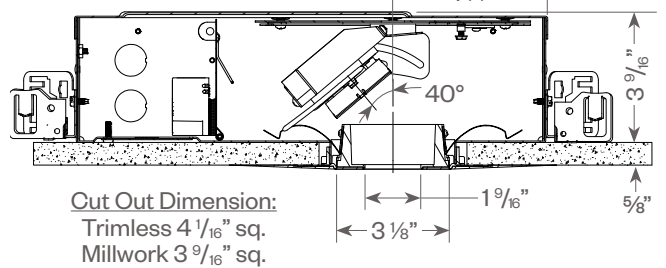

**Square Pinhole Shower Trimmed**

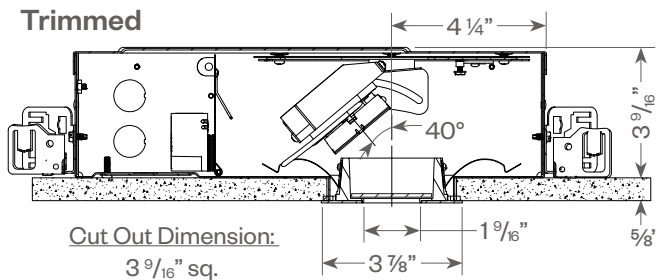

# Solace Square Adjustables

3" Shallow Square Adjustables



**PROJECT:**

**TYPE:**

## Solace Round Downlights Performance Breakdown (no Solite)

Wattage	Color Temp	SP (15°)		FL (25°)		WF (36°)		VWF (55°)		Pinhole Spot (15°)	
		Lumens	LPW	Lumens	LPW	Lumens	LPW	Lumens	LPW	Lumens	LPW
8W	27	782	93	823	98	754	90	809	96	400	48
	30	798	95	840	100	769	92	826	98	409	49
	35	814	97	856	102	784	93	842	100	417	50
	40	838	100	881	105	807	96	867	103	429	51
	279	670	80	705	84	646	77	694	83	343	41
	309	694	83	730	87	669	80	718	86	355	42
	359	718	85	756	90	692	82	743	88	368	44
	409	718	85	756	90	692	82	743	88	368	44
	CRISP	518	62	546	65	500	60	537	64	266	32
	3CLA	558	66	588	70	538	64	578	69	286	34
12W	27	1150	92	1211	97	1109	89	1191	95	589	47
	30	1174	94	1236	99	1132	91	1215	97	601	48
	35	1197	96	1260	101	1154	92	1240	99	613	49
	40	1233	99	1297	104	1188	95	1276	102	631	51
	279	986	79	1038	83	951	76	1021	82	505	40
	309	1021	82	1075	86	985	79	1057	85	523	42
	359	1057	85	1112	89	1019	81	1094	87	541	43
	409	1057	85	1112	89	1019	81	1094	87	541	43
	CRISP	763	61	803	64	736	59	790	63	391	31
	3CLA	822	66	865	69	792	63	851	68	421	34
17W	27	1475	88	1552	92	1422	85	1527	91	755	45
	30	1505	90	1584	94	1451	86	1558	93	771	46
	35	1535	91	1616	96	1480	88	1589	95	786	47
	40	1580	94	1663	99	1524	91	1636	97	809	48
	279	1264	75	1331	79	1219	72	1309	78	648	39
	309	1309	78	1378	82	1262	75	1355	81	671	40
	359	1355	81	1426	85	1306	78	1402	84	694	41
	409	1355	81	1426	85	1306	78	1402	84	694	41
	CRISP	978	58	1030	61	943	56	1013	60	501	30
	3CLA	1054	63	1109	66	1016	60	1091	65	540	32

# Solace Square Adjustables

3" Shallow Square Adjustables



**PROJECT:**

**TYPE:**

**FIXTURE DATA:** (Complete photometric data (.ies format) available upon request)

**MULTIPLYING FACTORS:** (Multiplying Factor is based on 3000K-83 120V IES file on website)

Wattage:	8W	12W	17W
Factor:	0.53	0.78	1.0

Lens:	Solite
Factor:	0.95

CCT:	2700K-83	3000K-83	3500K-83	4000K-83
Factor:	0.98	1.0	1.02	1.05

CCT:	2700K-90+	3000K-90+	3500K-90+	4000K-90+	CRISP	3CLA
Factor:	0.84	0.87	0.90	0.90	0.65	0.70

**Solace Square Adjustable (SOL-SA) - 17W, 3000K-83, 0° Tilt Angle**

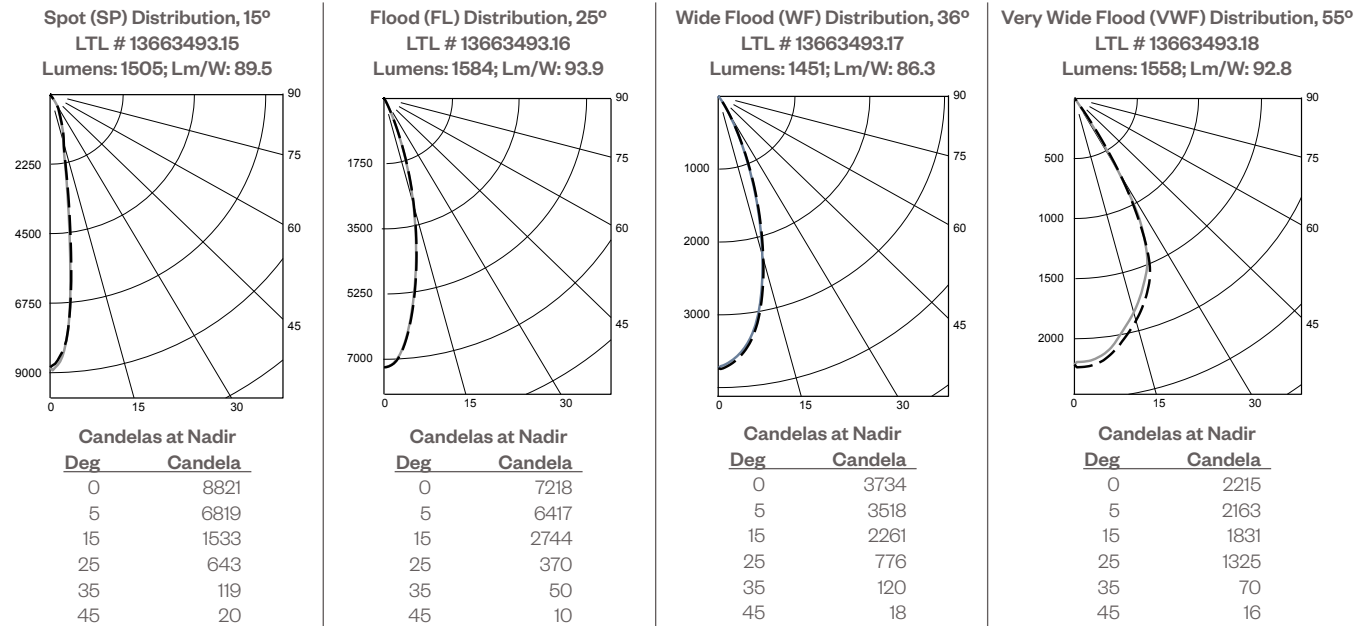

**Application Data:**

	0° Aiming Angle Horizontal Footcandles			
	D	FC	L	W
Spot	5.0'	353	1.3	1.3
	7.5'	157	2.0	2.0
	10.0'	89	2.8	2.8
	12.5'	57	3.4	3.4
Flood	5.0'	289	2.1	2.1
	7.5'	129	3.2	3.2
	10.0'	73	4.3	4.3
	12.5'	47	5.3	5.3
Wide Flood	5.0'	150	2.9	2.9
	7.5'	67	4.4	4.4
	10.0'	38	5.8	5.8
	12.5'	24	7.1	7.3
Very Wide Flood	5.0'	89	4.3	4.3
	7.5'	40	6.4	6.6
	10.0'	23	8.6	8.8
	12.5'	15	10.9	11.0

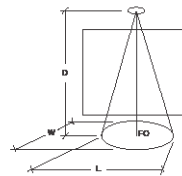

**Notes and Definitions:**

- Beam spread is to 50% center beam candpower (CBCP).
- D**=Distance to floor or wall.
- FC**=Footcandles on floor or wall at center beam aiming location.
- L**=Effective Visual Beam length in feet (50% of maximum footcandle level).
- W**=Effective Visual Beam width in feet (50% of maximum footcandle level).
- CB**=Distance across or down to center beam location.

# Solace Square Adjustables

3" Shallow Square Adjustables



**PROJECT:**

**TYPE:**

**FIXTURE DATA:** (Complete photometric data (.ies format) available upon request)

**MULTIPLYING FACTORS:** (Multiplying Factor is based on 3000K-83 120V IES file on website)

Wattage:	8W	12W	17W
Factor:	0.53	0.78	1.0

Lens:	Solite
Factor:	0.95

CCT:	2700K-83	3000K-83	3500K-83	4000K-83
Factor:	0.98	1.0	1.02	1.05

CCT:	2700K-90+	3000K-90+	3500K-90+	4000K-90+	CRISP	3CLA
Factor:	0.84	0.87	0.90	0.90	0.65	0.70

**Solace Square Adjustable (SOL-SA) - 17W, 3000K-83, 20° (approx.) Tilt Angle**

**Spot (SP) Distribution, 15°**  
LTL # 13663493.05  
Lumens: 1246; Lm/W: 73.8

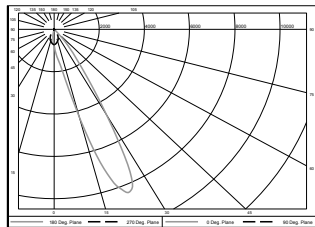

Candelas at Nadir	
Deg	Candela
0	746
5	1263
15	4268
25	8205
35	1828
45	74

**Flood (FL) Distribution, 25°**  
LTL # 13663493.06  
Lumens: 1419; Lm/W: 84.2

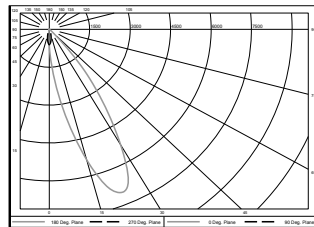

Candelas at Nadir	
Deg	Candela
0	626
5	1848
15	5352
25	6864
35	3341
45	278

**Wide Flood (WF) Distribution, 36°**  
LTL # 13663493.07  
Lumens: 1279; Lm/W: 75.9

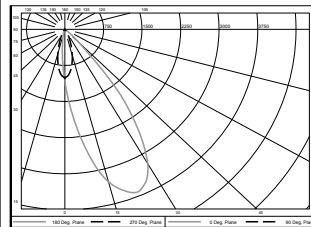

Candelas at Nadir	
Deg	Candela
0	1034
5	1817
15	3279
25	3603
35	2418
45	385

**Very Wide Flood (VWF) Distribution, 55°**  
LTL # 13663493.08  
Lumens: 1275; Lm/W: 75.9

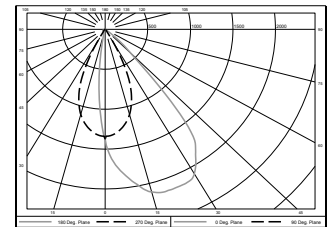

Candelas at Nadir	
Deg	Candela
0	1376
5	1745
15	2108
25	2149
35	1846
45	428

**Application Data:**

	25° Aiming Angle Horizontal Footcandles					25° Aiming Angle Vertical Footcandles				
	D	FC	L	W	CB	D	FC	L	W	CB
Spot	5.0'	263	1.5	1.4	2.0	3.0'	55	4.4	2.4	5.5
	7.5'	117	2.6	1.9	3.0	4.0'	34	5.7	2.9	7.5
	10.0'	66	3.3	2.6	4.0	5.0'	23	7.0	3.3	9.5
	12.5'	42	4.0	3.3	5.0	6.0'	17	8.4	3.7	11.5
Flood	5.0'	224	2.4	2.2	2.0	3.0'	63	4.5	3.0	5.5
	7.5'	99	3.6	3.3	3.0	4.0'	38	5.8	3.7	6.5
	10.0'	56	4.8	4.5	4.0	5.0'	25	7.2	4.5	8.5
	12.5'	36	6.0	5.6	5.0	6.0'	18	8.9	5.4	10.5
Wide Flood	5.0'	117	3.1	3.0	2.0	3.0'	44	4.1	3.3	4.5
	7.5'	53	4.7	4.5	2.0	4.0'	26	5.3	4.2	5.5
	10.0'	30	6.2	5.9	3.0	5.0'	18	6.4	5.2	7.5
	12.5'	20	7.8	7.4	4.0	6.0'	12	7.8	6.2	8.5
Very Wide Flood	5.0'	76	3.9	4.3	1.0	3.0'	35	3.6	3.8	4.5
	7.5'	34	5.9	6.5	2.0	4.0'	22	4.3	4.8	5.5
	10.0'	19	7.9	8.7	2.0	5.0'	14	5.4	6.2	6.5
	12.5'	13	9.9	10.8	3.0	6.0'	10	6.6	7.5	7.5

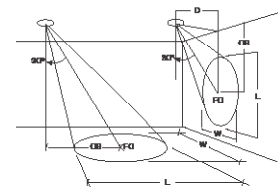

**Notes and Definitions:**

Beam spread is to 50% center beam candlepower (CBCP).

**D**=Distance to floor or wall.

**FC**=Footcandles on floor or wall at center beam aiming location.

**L**=Effective Visual Beam length in feet (50% of maximum footcandle level).

**W**=Effective Visual Beam width in feet (50% of maximum footcandle level).

**CB**=Distance across or down to center beam location.

# Solace Square Adjustables

3" Shallow Square Adjustables



**PROJECT:**

**TYPE:**

**FIXTURE DATA:** (Complete photometric data (.ies format) available upon request)

**MULTIPLYING FACTORS:** (Multiplying Factor is based on 3000K-83 120V IES file on website)

Wattage:	8W	12W	17W
Factor:	0.53	0.78	1.0

Lens:	Solite
Factor:	0.95

CCT:	2700K-83	3000K-83	3500K-83	4000K-83
Factor:	0.98	1.0	1.02	1.05

CCT:	2700K-90+	3000K-90+	3500K-90+	4000K-90+	CRISP	3CLA
Factor:	0.84	0.87	0.90	0.90	0.65	0.70

**Solace Square Pinhole Adjustable (SOL-SPA) - 17W, 3000K-83**

**0° Tilt Angle**  
**Spot (SP) Distribution, 15°**  
**LTL # 13663493.20A**  
**Lumens: 771; Lm/W: 45.9**

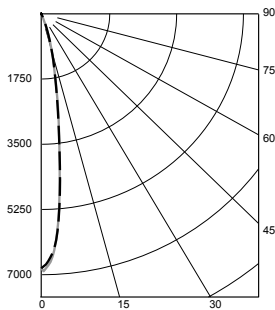

Candelas at Nadir	
Deg	Candela
0	6831
5	5147
15	1008
25	44
35	10
45	5

**20° (approx.) Tilt Angle**  
**Spot (SP) Distribution, 15°**  
**LTL # 13663493.10**  
**Lumens: 571; Lm/W: 34**

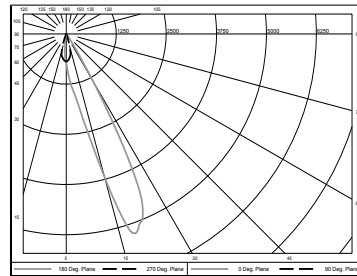

Candelas at Nadir	
Deg	Candela
0	702
5	1233
15	3684
25	4376
35	147
45	10

**Application Data:**

**0° Aiming Angle Horizontal Footcandles**

Spot	D	FC	L	W
	5.0'	273	1.3	1.3
7.5'	122	1.9	1.9	
10.0'	68	2.8	2.8	
12.5'	44	3.4	3.4	

**23° Aiming Angle Horizontal Footcandles**

Spot	D	FC	L	W	CB
	5.0'	162	1.6	1.4	2.0
7.5'	72	2.5	1.9	3.0	
10.0'	41	3.3	2.9	3.0	
12.5'	28	3.9	3.4	4.0	

**23° Aiming Angle Vertical Footcandles**

Spot	D	FC	L	W	CB
	3.0'	28	4.2	2.3	6.5
4.0'	17	5.3	2.8	8.5	
5.0'	12	6.6	3.4	10.5	
6.0'	8	8.3	3.9	12.5	

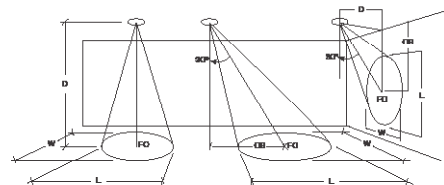

**Notes and Definitions:**

- Beam spread is to 50% center beam candlepower (CBCP).
- D=Distance to floor or wall.
- FC=Footcandles on floor or wall at center beam aiming location.
- L=Effective Visual Beam length in feet (50% of maximum footcandle level).
- W=Effective Visual Beam width in feet (50% of maximum footcandle level).
- CB=Distance across or down to center beam location.



# Solace Square Adjustables

3" Shallow Square Adjustables



## PROJECT:

## TYPE:

### DIMMING COMPATIBILITY:

Amerlux® Solace fixtures are compatible with all major dimming protocols prevalent in the United States. Please see below for general compatibilities and wiring diagrams. Amerlux recommends testing your unique dimming configuration as the exact full configuration (Dimmer, Fixture Quantity, Voltage, etc) may affect dimming performance.

**--- NOTE: INFORMATION BELOW IS FOR WIRED DIMMERS ONLY. FOR WIRELESS DIMMERS, CONSULT FACTORY ---**

### TRIAC (Forward Phase) DIMMING (Standard)

Utilizes standard TRIAC dimmers that are in wide use in installations across the US. Best for retrofit applications where TRIAC dimmers are installed.

#### Notes:

- 120VAC or 277VAC\*
- Dims down to 5% light output (most cases)
- Consult Dimming manufacturer for installation instructions - DO NOT SHARE NEUTRALS!
- Must meet dimmer Minimum Load Requirements per dimming manufacturer

TRIAC Wiring Diagram

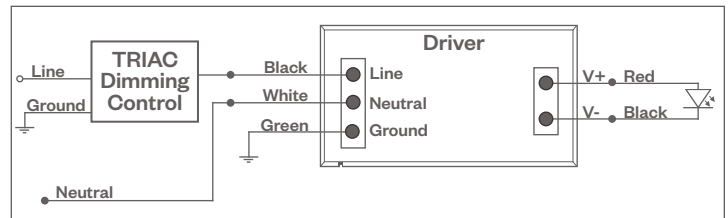

#### Compatible Dimmers†:

Wall Box (TRIAC 120VAC)	Central System
Lutron "Diva"	Lutron "GP" Panel
Lutron "Nova-T"	Lutron Grafik Eye QS
Lutron "Maestro"	
Lutron "Vareo"	
Lutron "Skylark"	

### ELV - Electronic Low Voltage (Reverse Phase) DIMMING (Standard)

Utilizes specialized "ELV" dimmers.

#### Notes:

- 120VAC or 277VAC\*
- Dims down to 5% light output (most cases)
- Consult Dimming manufacturer for installation instructions - DO NOT SHARE NEUTRALS!
- Must meet dimmer Minimum Load Requirements

ELV Wiring Diagram

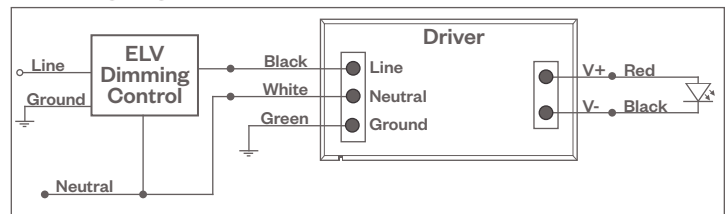

#### Compatible Dimmers†:

Wall Box (ELV 120VAC)	Wall Box (ELV 277VAC)	Central System
Lutron "Diva"	Leviton Revoir II AWSMT-E	Lutron "GP" Panel with PHPM-PA 120/277VAC
Lutron "Nova-T"		Lutron Grafik Eye QS with PHPM-PA 120/277VAC
Lutron "Maestro"		
Lutron "Vareo"		
Lutron "Skylark"		
Leviton "Surslide"		
Leviton "Vizio"		

#### Notes:

- \* Driver is 277VAC dimmable with appropriate dimmer (by others). All provided wiring diagrams show 120VAC wiring colors and method. Please refer to 277VAC dimmer manufacturer installation instructions for 277VAC wiring diagrams.
- † The absence of a dimmer from the lists above does not imply incompatibility. Please consult factory for compatibility inquiries.

# Solace Square Adjustables

3" Shallow Square Adjustables



**PROJECT:**

**TYPE:**

**DIMMING COMPATIBILITY:**

Amerlux® Solace fixtures are compatible with all major dimming protocols prevalent in the United States. Please see below for general compatibilities and wiring diagrams. Amerlux recommends testing your unique dimming configuration as the exact full configuration (Dimmer, Fixture Quantity, Voltage, etc) may affect dimming performance.

**--- NOTE: INFORMATION BELOW IS FOR WIRED DIMMERS ONLY. FOR WIRELESS DIMMERS, CONSULT FACTORY ---**

**0-10V DIMMING**

Integrates into a variety of building management and daylighting controls

**Notes:**

- 120VAC or 277VAC\*
- Dims down to 1% light output
- Requires interface to turn off power to driver
- Consult Dimming manufacturer for installation instructions - DO NOT SHARE NEUTRALS!

**0-10V Wiring Diagram**

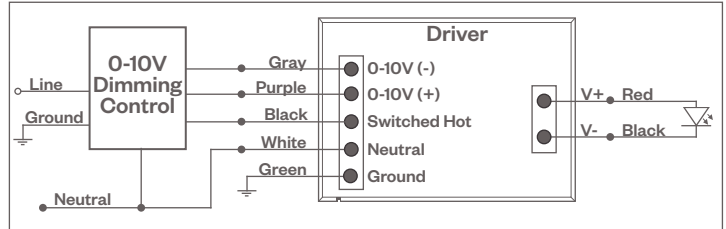

**Compatible Dimmers\*:**

**Wall Box**

Lutron "Diva" - DTVV with PP-120H Interface

Leviton Renoir II 0-10V

**Central System**

Lutron Grafik Eye with GRX-TV1 Interface

**LUTRON ECOSYSTEM DIMMING**

Integrates into Lutron EcoSystem building management

**Notes:**

- 120VAC or 277VAC\*
- Dims down to 0.1% light output
- EcoSystem Control
- Consult Dimming manufacturer for installation instructions - DO NOT SHARE NEUTRALS!

**HILUME-P-ECO**

**EcoSystem Digital Control Wiring Diagram**

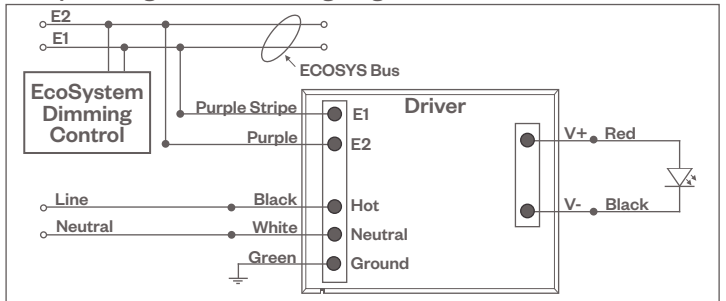

**Compatible Dimmers\*:**

**Lutron ECO System**

Pow Pak Dimming Modules  
 Energi Savr Node  
 Grafik Eye QS/Homeworks  
 QS Control Unit  
 Quantum Hub  
 Homeworks QS/My Room

**Central System**

Lutron EcoSystem compatible controls

**Notes:**

- \* Driver is 277VAC dimmable with appropriate dimmer (by others). All provided wiring diagrams show 120VAC wiring colors and method. Please refer to 277VAC dimmer manufacturer installation instructions for 277VAC wiring diagrams.
- † The absence of a dimmer from the lists above does not imply incompatibility. Please consult factory for compatibility inquiries.