

# Solace

## 3" Shallow Square Downlights



### Features

Solace 3" Downlights are the complete downlight family for any ceiling surface and low plenum ceiling. Round or Square apertures, available as downlight, adjustable or wallwash. Optional Solite lensing provides whisper quiet aesthetics. The trim options available as trimmed, trimless or millwork. The pinhole and shower pinhole trim makes this a complete a downlight to design the entire space with the same look.

### Product Overview

Type:	Shallow Square Downlight
Wattage:	8, 12, 17
Max Lumen Output:	1649 lm; 98.1 lm/W (Flood optics)
CBCP:	7639 (Flood optics)
Color Temp:	2700K, 3000K, 3500K, 4000K
CRI:	83 typ. 90+ typ. CrispWhite & 3K Class A available
Dimming:	TRIAC & ELV - 5% Dim 0-10V - 1% Dim Lutron <sup>+</sup> Hi-lume EcoSystem Premier 0.1% dim with soft on & fade to black

**+ Consult factory for Lutron lead time**

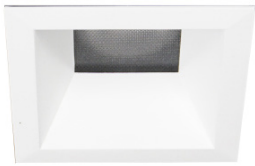

Downlight  
(shown with Solite lens)



Downlight Trimless

### PROJECT:

### TYPE:



Pinhole Downlight



Pinhole Downlight  
Trimless



Pinhole Downlight Shower

### Fixture Type

Round/Square	New Construction	Trimmed	Trimless	Millwork
Yes	Yes	Yes	Yes	Yes

See separate spec sheet for Round trim fixture

### Performance Chart (see page 5 for full breakdown)

Watts	Delivered Lumens	LPW	CBCP	Color Temp
8	874	104	4049	3000K-83
12	1286	103	5958	3000K-83
17	1649	98	7639	3000K-83

Data is based on 3000K-83 IES files available on website.

Data is Flood optic (no Solite). See page 6-7 for other beam spreads.

### Electrical Data

	8W		12W		17W	
	System Watts	Amps	System Watts	Amps	System Watts	Amps
120V	8	0.067	12	0.10	17	0.142
277V	8	0.029	12	0.043	17	0.061

Electronic constant current LED driver



# Solace Square Downlights

3" Shallow Square Downlights



## PROJECT:

## TYPE:

### Housing/Frame Ordering Information

1	2	3	4	5	6	7	8
<p><b>1</b> <u>Model</u>  <b>SOL-SD-NC</b> (New Construction &amp; Insulated Ceiling (IC rated))  <b>SOL-SD-CP</b> (Chicago Plenum (CCEA) housing)  <b>SOL-SD-IC</b> (Insulated Ceiling (IC rated) &amp; Air Tight)</p>	<p><b>2</b> <u>Style</u>  <b>T</b> - trimmed, 2" max ceiling thickness  <b>TL</b> - trimless, 5/8" max ceiling thickness  <b>MWK</b> - millwork (for 1/2" - 11/16" ceiling thickness)  <b>MWK1</b> - millwork (for 3/4" - 1-1/2" ceiling thickness)  <b>MWK2</b> - millwork (for 1-1/2" - 2" ceiling thickness)</p>	<p><b>3</b> <u>Wattage</u> (3000K-83, FL beam. See pg 5 for performance table)  <b>8</b> (874 lm)  <b>12</b> (1286 lm)  <b>17</b> (1649 lm)</p>	<p><b>4</b> <u>Voltage</u>  <b>120/277</b> - universal voltage</p>	<p><b>5</b> <u>Beam Spreads</u>  <b>SP</b> - spot, 15°  <b>FL</b> - flood, 25°  <b>WF</b> - wide flood, 36°  <b>VWF</b> - very wide flood, 55°</p>	<p><b>6</b> <u>Color Temp</u>  <b>83 CRI</b> <u>90+ CRI</u>  <b>27</b> - 2700K-83 <b>279</b> - 2700K-90+ <b>CRISP*</b> - CrispWhite  <b>30</b> - 3000K-83 <b>309</b> - 3000K-90+ <b>3CLA*</b> - 3K Class A  <b>35</b> - 3500K-83 <b>359</b> - 3500K-90+  <b>40*</b> - 4000K-83 <b>409*</b> - 4000K-90+  <b>* Consult factory for lead time</b></p>	<p><b>7</b> <u>Driver</u> (for non-dimming, select LE/TE option)  <b>LE/TE</b> - TRIAC/ELV, 5% dim  <b>0-10V</b> - 0-10V, 1% dim  <b>HILUME-P-ECO*</b> - Lutron Hi-lume EcoSystem Premier 0.1% dim with soft on &amp; fade to black  <b>+ Consult factory for Lutron lead time</b></p>	<p><b>8</b> <u>Options</u>  <b>HB49</b> - hanger bars from min 29" to max 49" (26" hanger bars included as default option)</p>

### Trim Ordering Information

1	2	3	4
<p><b>1</b> <u>Model</u>  <b>SOL-SD</b> (downlight)  <b>SOL-SPD</b> (pinhole downlight)  <b>SOL-SPDSHW</b> (pinhole downlight shower)</p>	<p><b>2</b> <u>Style</u>  <b>T</b> - trimmed  <b>TL</b> - trimless (not available for use with shower trims)  <b>MWK</b> - millwork (not available for use with shower trims)</p>	<p><b>3</b> <u>Finish - SD trim</u>  <u>Trimmed</u>  <b>MBW</b> - matte black, white flange  <b>MWW</b> - matte white, white flange  <b>SLVW</b> - matte silver, white flange  <b>MBB</b> - matte black, black flange  <b>SLVS</b> - matte silver, silver flange  <u>Finish - SPD/SPDSHW trims (Trimmed/Trimless/Millwork)</u>  <b>MB</b> - matte black  <b>MW</b> - matte white  <b>SLV</b> - matte silver</p>	<p><b>4</b> <u>Options/Accessories</u>  <b>SOL</b> - solite beam softening lens (comes standard with SPDSHW trim)</p>

# Solace Square Downlights

3" Shallow Square Downlights



## PROJECT:

## TYPE:

### Specifications

#### Application

Retail and commercial ambient and task lighting

#### Housing Construction

20 ga. steel painted matte black  
Extruded aluminum heatsink  
Formed aperture plate with 5/8" lip (GB-standard)  
Cast aluminum plaster frame with perforated face (for trimless option)  
Integral adjustable locking mounting bars  
Inherently protected

#### Reflector Trim Construction

Die-cast reflector  
Pinhole trim features die cast faceplate and baffle  
Pinhole shower trim features solite glass lens and silicone flange gasket

#### Optical

Beam spreads: Spot, 15°; Flood, 25°; Wide Flood, 36°;  
Very Wide Flood, 55°  
Optional **SOL** - solite beam softening lens (up to ~5° widening of beam)

#### LED

Color Temp Options: 2700K, 3000K, 3500K, 4000K  
CRI: 83 typ. (2700K, 3000K, 3500K, 4000K)  
90+ typ. (2700K, 3000K, 3500K, 4000K)  
CrispWhite\* & Class A\*\* 3000K (high gamut) available  
R9 Values: 11 (83 CRI), 55 (92 CRI)  
Binning: 3 MacAdam (SDCM)  
Life: 50,000+ hrs, > 70% of initial lumens at 50,000 hrs

*\*CrispWhite: CrispWhite Technology delivers the warmth of colors expected from a high 90 CRI solution but also creates the natural crisp white color that is pleasing to the eye. It creates the most impactful lighting ever available, by revealing the richest whites and vibrant colors that pop.*

*\*\*Class A LED: Class A LED's have a CRI > 80 and a GAI > 80. CRI defines color "Naturalness" and GAI defines color "Saturation." Both being high delivers rich colors and pure whites.*

#### Electrical

Wattage: 8, 12, 17  
Electronic constant current LED driver, 120/277VAC input  
**This product complies with IEEE C62.41 for surge endurance up to 2.5KV. Amerlux® recommends using additional surge protection with this unit (supplied by others), surge and over voltage damage is not covered under warranty.**  
Emergency option available through circuiting/inverter only

#### Drivers

LE/TE - Leading Edge, TRIAC, forward phase/Trailing Edge, ELV, reverse phase (standard)  
0-10V and Lutron systems also available  
See pages 8-9 for more dimming information

#### Finish (Trim)

Powder coat paint

#### Mounting

26" Hanger bars included. Side brackets allow for rigid conduit pipe mounting along with additional 1/2" adjustment of housing vertical position  
Optional **HB49** - hanger bars from min 29" to max 49" available  
**Trimmed Fixture:**  
For use in grid or sheetrock ceilings, 5/8" - 2" standard  
**Trimless Fixture (not available with Shower trim):**  
For use in sheetrock ceilings, max ceiling thickness 5/8"  
For sheetrock ceilings beyond 5/8" consult factory  
**Millwork Fixture:**  
Millwork extension collars are based on ceiling material specifications and thickness. Provides flush trim appearance level with ceiling material. Max thickness 2"

#### Certifications

CSA damp as tested to UL 1598 standards  
Wet location (SHW trim) - for indoor, high humidity/moisture from below applications only  
IC/AT rated

#### Warranty

5 year limited warranty

#### Weight

Housing and trim - 5 lbs.

# Solace Square Downlights

3" Shallow Square Downlights



## PROJECT:

## TYPE:

### Solace Square Downlights

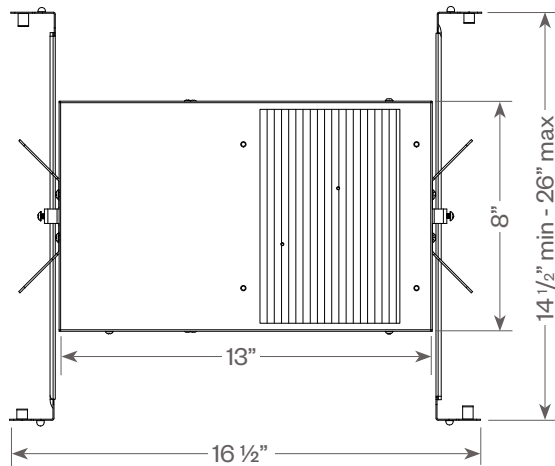

### Plaster Frame Installation Detail (for trimless fixture only)

1. Reflector Trim
2. Aperture plate
3. Ceiling 5/8"
4. Cast Aluminum Plaster Frame
5. Plaster Skim Coat (by others)
6. 6-32 Type F Thread Cutting Screw

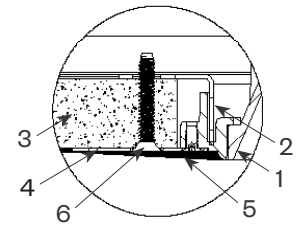

### Millwork Detail

1. Reflector Trim
2. Millwork Ring
3. Aperture Plate
4. Wood Ceiling 2" Max
5. Extension collar (see ordering information for ceiling thicknesses)
6. 1/16" required for trim to be flush with ceiling

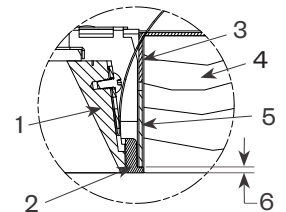

## Square Downlight

### Trimmed

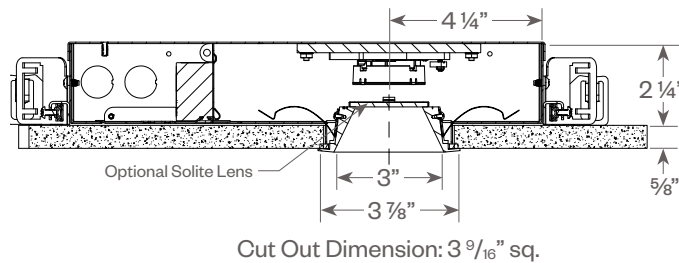

### Trimless & Millwork

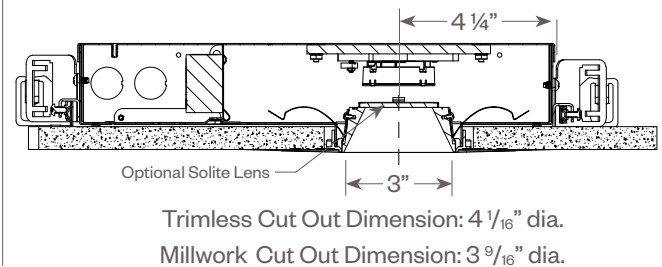

## Square Pinhole Downlight

### Trimmed

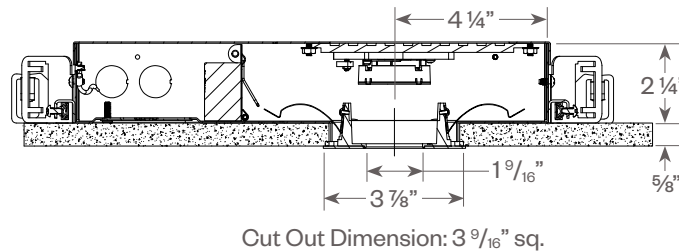

### Trimless & Millwork

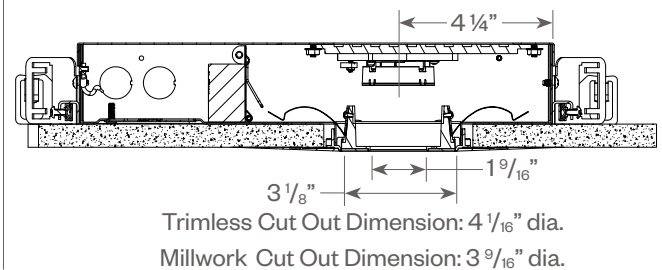

## Square Pinhole Downlight Shower

### Trimmed

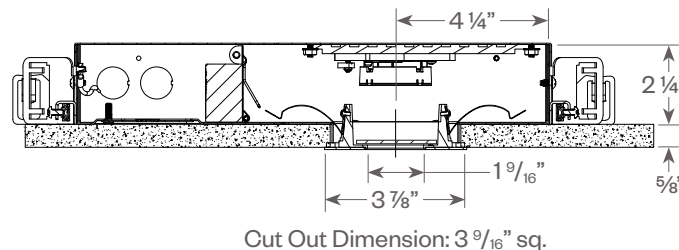

# Solace Square Downlights

3" Shallow Square Downlights



PROJECT:

TYPE:

## Solace Round Downlights Performance Breakdown (no Solite)

Wattage	Color Temp	SP (15°)		FL (25°)		WF (36°)		VWF (55°)		Pinhole Spot (15°)	
		Lumens	LPW	Lumens	LPW	Lumens	LPW	Lumens	LPW	Lumens	LPW
8W	27	818	97	856	102	785	93	839	100	419	50
	30	835	99	874	104	801	95	856	102	428	51
	35	851	101	891	106	817	97	873	104	436	52
	40	876	104	918	109	841	100	899	107	449	53
	279	701	83	734	87	673	80	719	86	359	43
	309	726	86	760	91	697	83	745	89	372	44
	359	751	89	787	94	721	86	770	92	385	46
	409	751	89	787	94	721	86	770	92	385	46
	CRISP	543	65	568	68	521	62	556	66	278	33
	3CLA	584	70	612	73	561	67	599	71	300	36
12W	27	1204	96	1260	101	1155	92	1235	99	617	49
	30	1229	98	1286	103	1179	94	1260	101	630	50
	35	1253	100	1312	105	1202	96	1285	103	642	51
	40	1290	103	1351	108	1238	99	1323	106	661	53
	279	1032	83	1080	86	990	79	1058	85	529	42
	309	1069	86	1119	90	1025	82	1096	88	548	44
	359	1106	88	1158	93	1061	85	1134	91	567	45
	409	1106	88	1158	93	1061	85	1134	91	567	45
	CRISP	799	64	836	67	766	61	819	66	409	33
	3CLA	860	69	900	72	825	66	882	71	441	35
17W	27	1544	92	1616	96	1481	88	1583	94	791	47
	30	1575	94	1649	98	1511	90	1615	96	807	48
	35	1607	95	1682	100	1541	92	1647	98	823	49
	40	1654	98	1731	103	1587	94	1696	101	848	50
	279	1323	79	1385	82	1269	76	1357	81	678	40
	309	1370	81	1435	85	1315	78	1405	84	702	42
	359	1418	84	1484	88	1360	81	1454	86	727	43
	409	1418	84	1484	88	1360	81	1454	86	727	43
	CRISP	1024	61	1072	64	982	58	1050	62	525	31
	3CLA	1103	66	1154	69	1058	63	1131	67	565	34

# Solace Square Downlights

3" Shallow Square Downlights



**PROJECT:**

**TYPE:**

**FIXTURE DATA:** (Complete photometric data (.ies format) available upon request)

**MULTIPLYING FACTORS:** (Multiplying Factor is based on 3000K-83 120V IES file on website)

Wattage:	8W	12W	17W
Factor:	0.53	0.78	1.0

Lens:	Solite
Factor:	0.95

CCT:	2700K-83	3000K-83	3500K-83	4000K-83
Factor:	0.98	1.0	1.02	1.05

CCT:	2700K-90+	3000K-90+	3500K-90+	4000K-90+	CRISP	3CLA
Factor:	0.84	0.87	0.90	0.90	0.65	0.70

**Solace Square Downlight (SOL-SD) - 17W, 3000K-83**

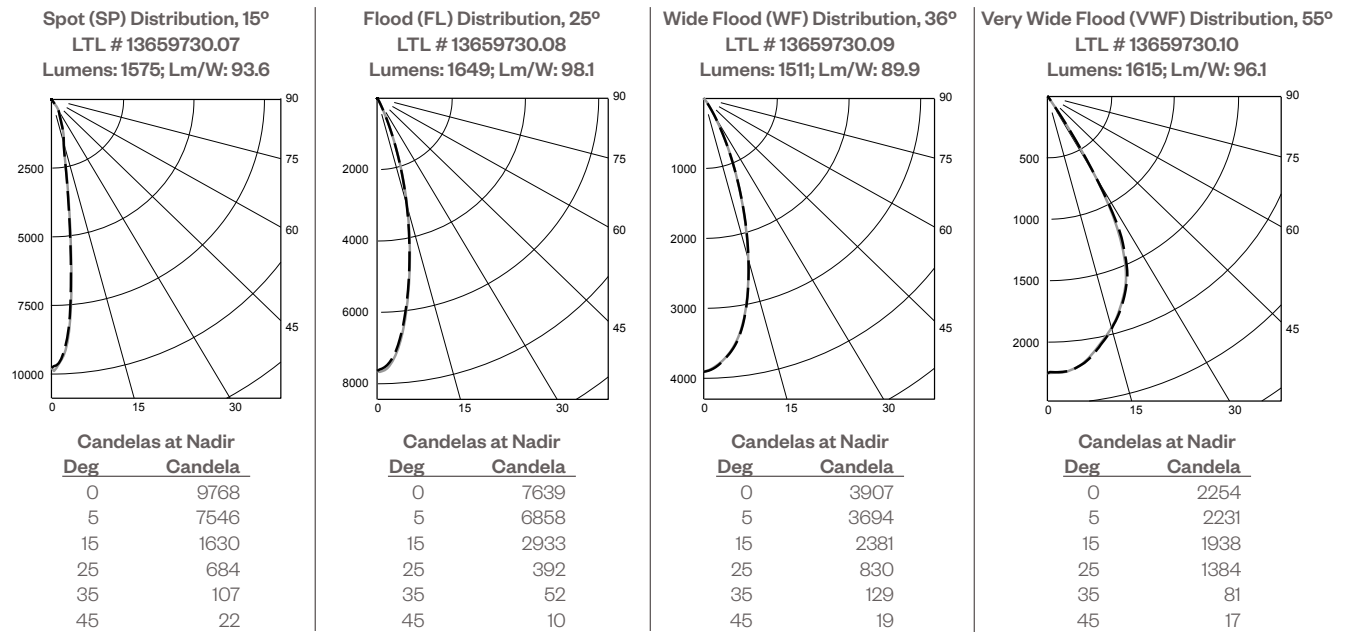

**Application Data:**

**0° Aiming Angle  
Horizontal  
Footcandles**

	D	FC	L	W
<b>Spot</b>	5.0'	391	1.3	1.3
	7.5'	174	1.9	1.9
	10.0'	98	2.8	2.8
	12.5'	63	3.4	3.4
<b>Flood</b>	5.0'	306	2.1	2.1
	7.5'	136	3.2	3.2
	10.0'	77	4.3	4.3
	12.5'	49	5.4	5.4
<b>Wide Flood</b>	5.0'	157	2.9	2.9
	7.5'	70	4.4	4.4
	10.0'	39	5.7	5.7
	12.5'	25	7.2	7.2
<b>Very Wide Flood</b>	5.0'	91	4.4	4.4
	7.5'	40	6.6	6.6
	10.0'	23	8.9	9.0
	12.5'	15	11.1	11.3

**Notes and Definitions:**

- Beam spread is to 50% center beam candlepower (CBCP).
- D**=Distance to floor or wall.
- FC**=Footcandles on floor or wall at center beam aiming location.
- L**=Effective Visual Beam length in feet (50% of maximum footcandle level).
- W**=Effective Visual Beam width in feet (50% of maximum footcandle level).
- CB**=Distance across or down to center beam location.

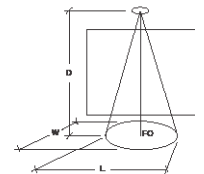

# Solace Square Downlights

3" Shallow Square Downlights



## PROJECT:

## TYPE:

**FIXTURE DATA:** (Complete photometric data (.ies format) available upon request)

**MULTIPLYING FACTORS:** (Multiplying Factor is based on 3000K-83 120V IES file on website)

Wattage:	8W	12W	17W
Factor:	0.53	0.78	1.0

Lens:	Solite
Factor:	0.95

CCT:	2700K-83	3000K-83	3500K-83	4000K-83
Factor:	0.98	1.0	1.02	1.05

CCT:	2700K-90+	3000K-90+	3500K-90+	4000K-90+	CRISP	3CLA
Factor:	0.84	0.87	0.90	0.90	0.65	0.70

### Solace Square Pinhole Downlight (SOL-SPD) - 17W, 3000K-83

Spot (SP) Distribution, 15°  
LTL # 13659730.11  
Lumens: 807; Lm/W: 48

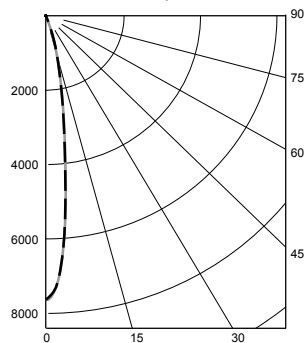

**Candelas at Nadir**

Deg	Candela
0	7636
5	5557
15	1062
25	45
35	10
45	4

### Application Data:

Spot	0° Aiming Angle Horizontal Footcandles			
	D	FC	L	W
5.0'	305	1.3	1.3	
7.5'	136	1.9	1.9	
10.0'	77	2.7	2.7	
12.5'	49	3.3	3.3	

### Notes and Definitions:

Beam spread is to 50% center beam candlepower (CBCP).

**D**=Distance to floor or wall.

**FC**=Footcandles on floor or wall at center beam aiming location.

**L**=Effective Visual Beam length in feet (50% of maximum footcandle level).

**W**=Effective Visual Beam width in feet (50% of maximum footcandle level).

**CB**=Distance across or down to center beam location.

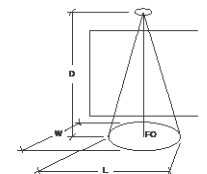

# Solace Square Downlights

3" Shallow Square Downlights



## PROJECT:

## TYPE:

### DIMMING COMPATIBILITY:

Amerlux® Solace fixtures are compatible with all major dimming protocols prevalent in the United States. Please see below for general compatibilities and wiring diagrams. Amerlux recommends testing your unique dimming configuration as the exact full configuration (Dimmer, Fixture Quantity, Voltage, etc) may affect dimming performance.

**--- NOTE: INFORMATION BELOW IS FOR WIRED DIMMERS ONLY. FOR WIRELESS DIMMERS, CONSULT FACTORY ---**

### TRIAC (Forward Phase) DIMMING (Standard)

Utilizes standard TRIAC dimmers that are in wide use in installations across the US. Best for retrofit applications where TRIAC dimmers are installed.

#### Notes:

- 120VAC or 277VAC\*
- Dims down to 5% light output (most cases)
- Consult Dimming manufacturer for installation instructions - DO NOT SHARE NEUTRALS!
- Must meet dimmer Minimum Load Requirements per dimming manufacturer

TRIAC Wiring Diagram

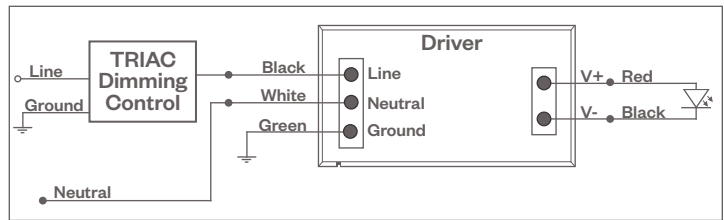

#### Compatible Dimmers†:

##### Wall Box (TRIAC 120VAC)

Lutron "Diva"  
Lutron "Nova-T"  
Lutron "Maestro"  
Lutron "Vareo"  
Lutron "Skylark"

##### Central System

Lutron "GP" Panel  
Lutron Grafik Eye QS

### ELV - Electronic Low Voltage (Reverse Phase) DIMMING (Standard)

Utilizes specialized "ELV" dimmers.

#### Notes:

- 120VAC or 277VAC\*
- Dims down to 5% light output (most cases)
- Consult Dimming manufacturer for installation instructions - DO NOT SHARE NEUTRALS!
- Must meet dimmer Minimum Load Requirements

ELV Wiring Diagram

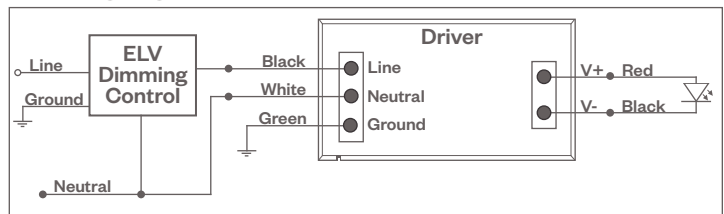

#### Compatible Dimmers†:

##### Wall Box (ELV 120VAC)

Lutron "Diva"  
Lutron "Nova-T"  
Lutron "Maestro"  
Lutron "Vareo"  
Lutron "Skylark"  
Leviton "Surslide"  
Leviton "Vizio"

##### Wall Box (ELV 277VAC)

Leviton Revoir II AWSMT-E

##### Central System

Lutron "GP" Panel with PHPM-PA 120/277VAC  
Lutron Grafik Eye QS with PHPM-PA 120/277VAC

#### Notes:

- \* Driver is 277VAC dimmable with appropriate dimmer (by others). All provided wiring diagrams show 120VAC wiring colors and method. Please refer to 277VAC dimmer manufacturer installation instructions for 277VAC wiring diagrams.
- † The absence of a dimmer from the lists above does not imply incompatibility. Please consult factory for compatibility inquiries.



# Solace Square Downlights

3" Shallow Square Downlights



**PROJECT:**

**TYPE:**

**DIMMING COMPATIBILITY:**

Amerlux® Solace fixtures are compatible with all major dimming protocols prevalent in the United States. Please see below for general compatibilities and wiring diagrams. Amerlux recommends testing your unique dimming configuration as the exact full configuration (Dimmer, Fixture Quantity, Voltage, etc) may affect dimming performance.

**--- NOTE: INFORMATION BELOW IS FOR WIRED DIMMERS ONLY. FOR WIRELESS DIMMERS, CONSULT FACTORY ---**

**0-10V DIMMING**

Integrates into a variety of building management and daylighting controls

**Notes:**

- 120VAC or 277VAC\*
- Dims down to 1% light output
- Requires interface to turn off power to driver
- Consult Dimming manufacturer for installation instructions - DO NOT SHARE NEUTRALS!

**0-10V Wiring Diagram**

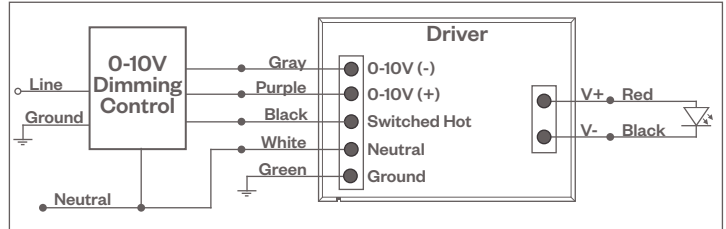

**Compatible Dimmers†:**

**Wall Box**

Lutron "Diva" - DTVV with PP-120H Interface

Leviton Renoir II 0-10V

**Central System**

Lutron Grafik Eye with GRX-TV1 Interface

**LUTRON ECOSYSTEM DIMMING**

Integrates into Lutron EcoSystem building management

**Notes:**

- 120VAC or 277VAC\*
- Dims down to 0.1% light output
- EcoSystem Control
- Consult Dimming manufacturer for installation instructions - DO NOT SHARE NEUTRALS!

**HILUME-P-ECO**

**EcoSystem Digital Control Wiring Diagram**

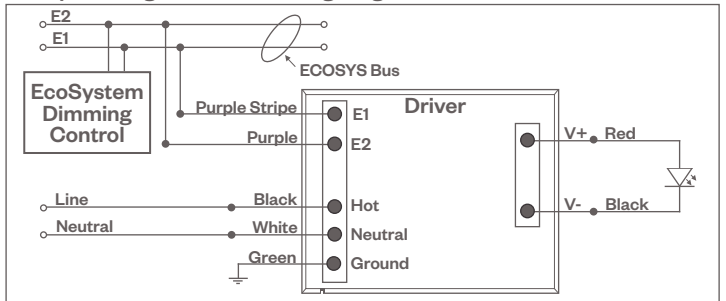

**Compatible Dimmers†:**

**Lutron ECO System**

Pow Pak Dimming Modules  
 Energi Savr Node  
 Grafik Eye QS/Homeworks  
 QS Control Unit  
 Quantum Hub  
 Homeworks QS/My Room

**Central System**

Lutron EcoSystem compatible controls

**Notes:**

\* Driver is 277VAC dimmable with appropriate dimmer (by others). All provided wiring diagrams show 120VAC wiring colors and method. Please refer to 277VAC dimmer manufacturer installation instructions for 277VAC wiring diagrams.

† The absence of a dimmer from the lists above does not imply incompatibility. Please consult factory for compatibility inquiries.