

# Rook® 350

3.5" Round Wall Mount  
Universal, Direct or Indirect  
Dim-To-Warm



## Features

The contemporary Rook 350 Direct or Indirect Wall Mount is universal allowing the fixture to be mounted as a Direct or Indirect luminaire just by flipping its orientation. Rook 350 has the same optical performance as our Hornet 3.5" Downlights. With only a 3.5" aperture the Rook 350 can be used to add visual interest to walls or columns. The Rook 350 cylinder family is available as a pendant, surface or wall mount allowing it to fit in any retail, hospitality or commercial environment. Our Dim-To-Warm option allows designers to simulate the familiar glow and dimming of incandescent lamps. By shifting to a lower Kelvin temperature, as you dim the lights, Dim-To-Warm can tap into the powerful mediums of light and color to enhance the experience and well-being.

## Product Overview

Type:	Round Wall Mount Universal, Direct or Indirect (Field changeable to indirect orientation)
Wattage:	13W
Lumen Output:	672 lm (RK350WR); 822 lm (RK350WRL)
Color Temp:	3000K to 1800K
CRI:	95 typ.
Dimming:	TRIAC & ELV (120V/277V) - 5% Dim 0-10V (120V/277V) - 1% Dim

Direct Wall Mount

Indirect Wall Mount

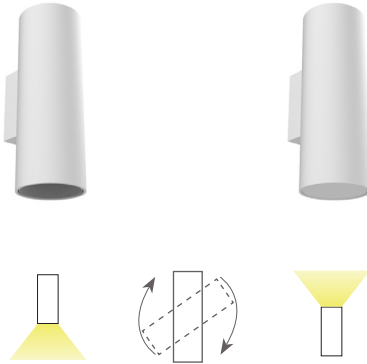

## PROJECT:

## TYPE:

Direct Remote Wall Mount

Indirect Remote Wall Mount



See page 4 for other mounting options

**Note: Indirect Mounting Kit provided with all fixtures to mount fixture for uplighting.**

## Performance Chart

Watts	Delivered Lumens	LPW	Color Temp
<b>RK350WR</b>			
13	672	51.7	3000K-95
<b>RK350WRL</b>			
13	822	63.2	3000K-83

## Electrical Data

	13W	
	System Watts	Amps
120V	13	0.11
277V	13	0.05

Electronic constant current LED driver

## Max. Fixture Weights

Model	Weight (lbs)
RK350WR(L)-U	5.4
RK350WR(L)-U-REMOTE	4.0

Remote driver & driver box are not included in weight

## Dim-To-Warm CCT Curve

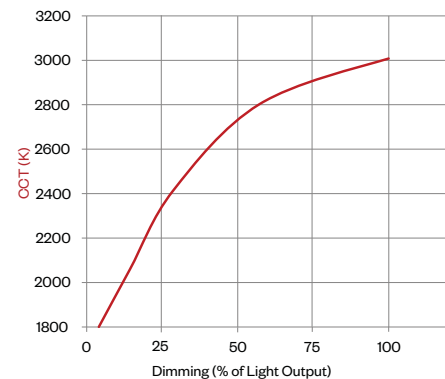

# Rook® 350

3.5" Round Wall Mount, Direct or Indirect, Dim-To-Warm



## PROJECT:

## TYPE:

### Ordering Information

	13			120-277				309	
<b>1</b>	<b>2</b>	<b>3</b>	<b>4</b>	<b>5</b>	<b>6</b>	<b>7</b>	<b>8</b>	<b>9</b>	

#### Open Unit

- 1** Model  
RK350WR-U-DTW  
RK350WR-U-DTW-REMOTE (remote driver)
- 2** Wattage  
13
- 3** Housing Finish  
MW - matte white  
MB - matte black  
SLV - matte silver
- 4** Mounting\* (matches housing finish)  
WM - wall mount (no wall plate)  
CWM - wall mount with wall plate  
CDWM - wall mount conduit cover
- 5** Voltage  
120-277
- 6** Trim Finish  
MW - matte white  
MB - matte black  
SLV - matte silver
- 7** Beam Spread  
VNF - narrow flood, 18°  
MFL - medium flood, 24°  
FL - flood, 28°  
WF - wide flood, 45°
- 8** Color Temp  
95 CRI  
309 - 3000K-95
- 9** Driver  
LE/TE - TRIAC/ELV dimming, 5% dim  
0-10V - 0-10V dimming; 1% dim

#### Lensed Unit

- 1** Model  
RK350WRL-U-DTW (Lensed)  
RK350WRL-U-DTW-REMOTE (Lensed, remote driver)
- 2** Wattage  
13
- 3** Housing Finish  
MW - matte white  
MB - matte black  
SLV - matte silver
- 4** Mounting\* (matches housing finish)  
WM - wall mount (no wall plate)  
CWM - wall mount with wall plate  
CDWM - wall mount conduit cover
- 5** Voltage  
120-277
- 6** Trim Finish  
MW - matte white  
MB - matte black  
SLV - matte silver
- 7** Beam Spread  
30SOL - 30° solite lens  
40SOL - 40° solite lens  
65SOL - 65° solite lens
- 8** Color Temp  
95 CRI  
309 - 3000K-95
- 9** Driver  
LE/TE - TRIAC/ELV dimming, 5% dim  
0-10V - 0-10V dimming; 1% dim

**\* Note: Indirect Mounting Kit provided with all fixtures to mount fixture for uplighting.**

RK350 Round Wall Mount-U-DTW

# Rook® 350

3.5" Round Wall Mount, Direct or Indirect, Dim-To-Warm



## PROJECT:

## TYPE:

### Specifications

#### Application

Commercial, hospitality and retail ambient/accent wall mounted fixtures.

#### Construction

Extruded aluminum pendant housing  
Die-cast trim  
Extruded aluminum heat sink  
Fixture shipped with dust cover for use when fixture is used as indirect

#### Optical

**RK350WR Beam Spreads:**  
Very Narrow Flood, 18°; Medium Flood, 24°; Flood, 35°;  
Wide Flood, 44°  
Linear Spread, 60° x 10°  
**RK350WRL Beam Spreads:**  
Solite Lens for maximum efficacy and a visually quieter aperture. 30°, 40° & 65° beam spread options. Visually best with SLV reflector finish.

#### LED

**Color Temp Options:** 3000K (Dims to 1800K)  
**CRI:** 95 typ. (± 3 across dimming range)  
**R9 Values:** 85  
**Binning:** 3 MacAdam (SDCM)  
**Life:** 50,000+ hrs, > 70% of initial lumens at 50,000 hrs

#### Electrical

**Wattage:** 13W  
Electronic constant current LED driver, 120V-277V input  
**This product complies with IEEE C62.41 for surge endurance up to 2.5KV. Amerlux® recommends using additional surge protection with this unit (supplied by others), surge and over voltage damage is not covered under warranty.**  
**For emergency:** Remote EM inverter or emergency circuit by others  
**Remote Driver Wiring:** Driver is supplied installed in remote driver box, (one driver per box), with 5' of low voltage plenum rated cable. Amerlux recommends a maximum of 15' between the fixture and the remote driver box. Consult factory with job specific electrical spec if more than 15' is required.

#### Drivers

LE/TE - Leading Edge, TRIAC, forward phase/Trailing Edge, ELV, reverse phase  
0-10V also available

#### Finish

Powder coat paint  
*Consult factory for custom finishes*

#### Mounting

Wall mounted (direct orientation), see options on pg 4  
**Note: For Indirect orientation, use the INDIRECT MOUNTING KIT**  
- Flip the mounting bracket  
- Mount the Dust cover provided in kit  
- Mounting bracket & design symmetrically centered

#### Certifications

CSA tested to UL standards  
Indoor use only  
Damp location

#### Warranty

5 year limited warranty

RK350 Round Wall Mount-U-DTW

# Rook® 350

3.5" Round Wall Mount, Direct or Indirect, Dim-To-Warm



## PROJECT:

## TYPE:

### Wall Mount

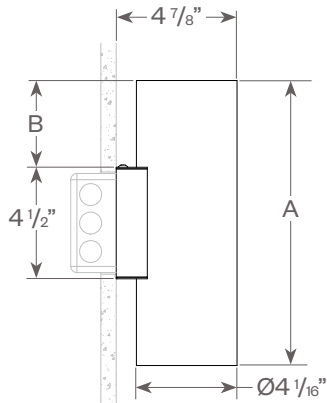

Wall Mount Fixtures are capable of being flipped to indirect.  
Dust cover provided with fixture for indirect orientation.

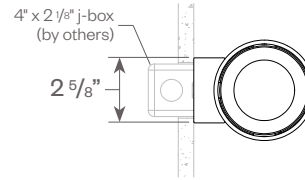

Fixture	A	B
RK350W(R/RL)	11 1/2"	3 1/2"
RK350W(R/RL)-REMOTE	6 1/2"	1"

### Wall Mount with Wall Plate

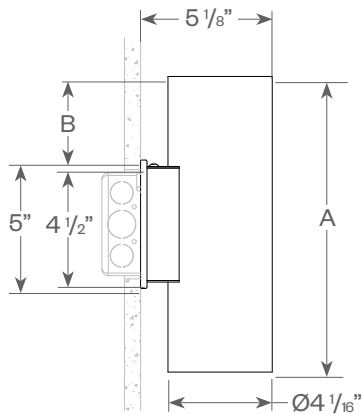

Wall Mount with Wall Plate Fixtures are capable of being flipped to indirect.  
Dust cover provided with fixture for indirect orientation.

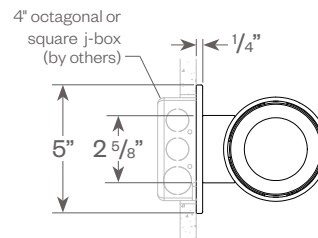

Fixture	A	B
RK350W(R/RL)	11 1/2"	3 1/4"
RK350W(R/RL)-REMOTE	6 1/2"	3/4"

### Wall Mount Conduit Cover

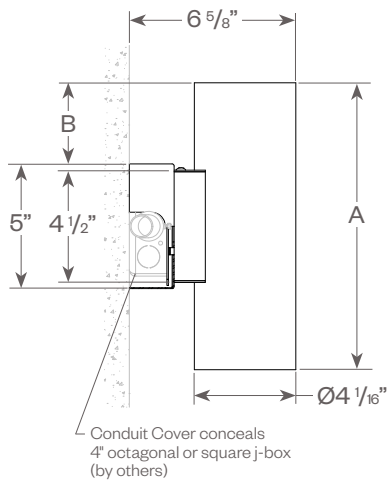

Wall Mount Conduit Cover Fixtures are capable of being flipped to indirect.  
Dust cover provided with fixture for indirect orientation.

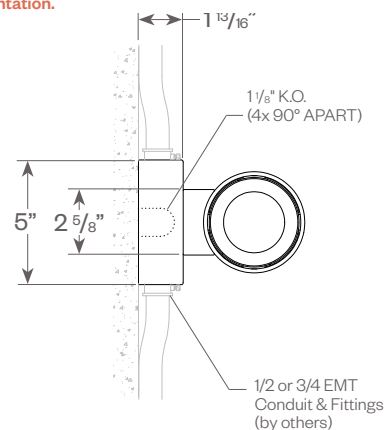

Fixture	A	B
RK350W(R/RL)	11 1/2"	3 1/4"
RK350W(R/RL)-REMOTE	6 1/2"	3/4"

### Remote Driver Box

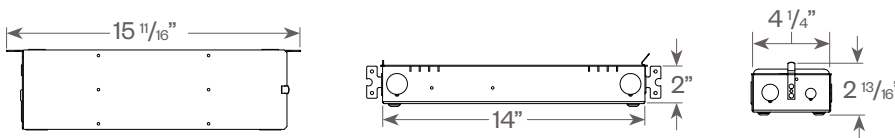

Driver is supplied installed in remote driver box, (one driver per box), with 15' of low voltage plenum rated cable. Amerlux recommends a maximum of 15' between the fixture and the remote driver box. Consult factory with job specific electrical spec if more than 15' is required.

# Rook® 350

3.5" Round Wall Mount, Direct or Indirect, Dim-To-Warm



**PROJECT:**

**TYPE:**

**RK350WR**

**FIXTURE DATA:** (Complete photometric data (.ies format) available upon request)

**13W LED, 3000K-95**

**Very Narrow Flood (VNF)**  
Distribution, 18°  
LTL #11919582.12  
Lumens: 672

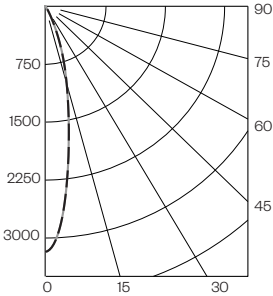

**Candelas at Nadir**

Deg	Candela
0	3179
5	2638
15	1030
25	252
35	43
45	10

**Medium Flood (MFL)**  
Distribution, 25°  
LTL#11919582.13  
Lumens: 609

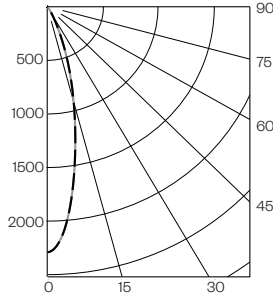

**Candelas at Nadir**

Deg	Candela
0	2291
5	2024
15	942
25	267
35	50
45	11

**Flood (FL)**  
Distribution, 35°  
LTL # 11919582.14  
Lumens: 582

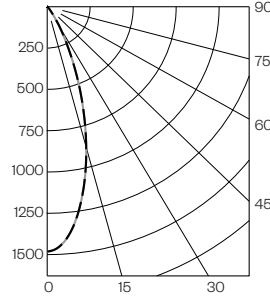

**Candelas at Nadir**

Deg	Candela
0	1481
5	1395
15	882
25	331
35	63
45	13

**Wide Flood (WF)**  
Distribution, 45°  
LTL # 11919582.15  
Lumens: 540

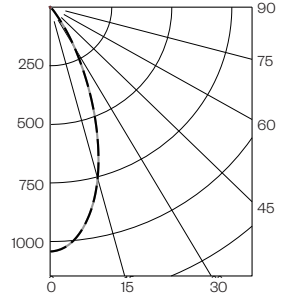

**Candelas at Nadir**

Deg	Candela
0	1042
5	1007
15	751
25	359
35	85
45	15

**Application Data:**

**RK350WR Mounted at 7' (to bottom of fixture) on wall**  
Footcandles on wall

	Very Narrow Flood									Medium Flood									Flood									Wide Flood								
Distance from fixture	0.5	0	0	1	51	52	0	0	0	0.5	0	0	0	50	54	0	0	0	0.5	0	0	1	60	49	0	0	0	0.5	0	0	1	50	62	0	0	0
	1.5	0	0	1	40	48	1	0	0	1.5	0	0	1	37	45	1	0	0	1.5	0	0	2	35	37	2	0	0	1.5	0	0	2	29	39	2	0	0
	2.5	0	0	2	17	20	2	0	0	2.5	0	0	2	14	16	2	0	0	2.5	0	0	2	12	13	2	0	0	2.5	0	0	2	9	10	3	0	0
	3.5	0	0	2	8	9	2	0	0	3.5	0	0	2	7	7	2	0	0	3.5	0	1	2	5	6	2	0	0	3.5	0	1	2	4	4	2	1	0
	4.5	0	1	2	5	5	2	1	0	4.5	0	1	2	4	4	2	1	1	4.5	0	1	2	3	3	2	1	0	4.5	0	1	2	3	3	2	1	0
	5.5	1	1	2	4	4	2	1	0	5.5	0	1	2	3	3	2	1	0	5.5	1	1	2	3	3	2	1	0	5.5	1	1	2	2	2	2	1	1
	6.5	1	1	2	4	4	2	1	1	6.5	0	1	2	3	3	2	1	0	6.5	1	1	2	2	2	2	1	1	6.5	0	1	1	1	1	1	1	1

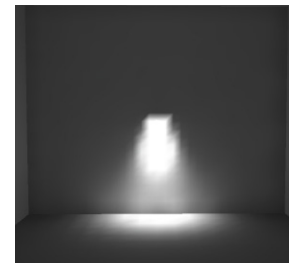
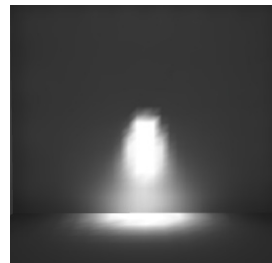
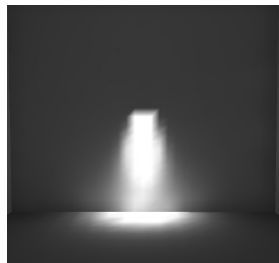
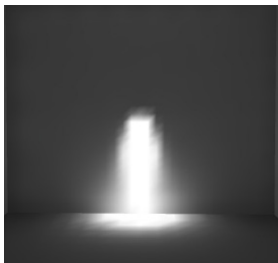

# Rook® 350

3.5" Round Wall Mount, Direct or Indirect, Dim-To-Warm



**PROJECT:**

**TYPE:**

**RK350WRL**

**FIXTURE DATA:** (Complete photometric data (.ies format) available upon request)

**13W LED, 3000K-95**

**30° Solite Lens**  
LTL # 11919582.24  
Lumens: 815

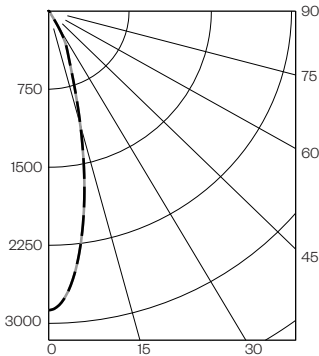

**Candelas at Nadir**

Deg	Candela
0	2874
5	2591
15	1168
25	411
35	41
45	18

**40° Solite Lens**  
LTL # 11919582.25  
Lumens: 822

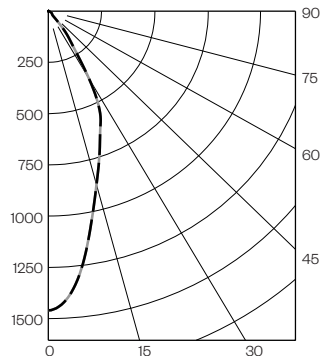

**Candelas at Nadir**

Deg	Candela
0	1460
5	1358
15	875
25	582
35	188
45	29

**65° Solite Lens**  
LTL # 11919582.26  
Lumens: 818

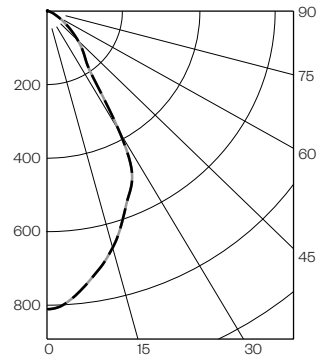

**Candelas at Nadir**

Deg	Candela
0	811
5	783
15	667
25	526
35	195
45	118

**Application Data:**

RK350WRL Mounted at 7' (to bottom of fixture) on wall  
Footcandles on wall

**30SOL**

Distance from fixture	30° Solite Lens							
	0.5	1.5	2.5	3.5	4.5	5.5	6.5	7.5
0.5	0	0	1	69	71	1	0	0
1.5	0	0	2	47	56	2	0	0
2.5	0	0	3	18	21	3	0	0
3.5	0	1	3	9	9	3	1	0
4.5	0	1	2	5	6	3	1	0
5.5	1	1	3	4	4	3	1	1
6.5	1	1	3	4	4	3	1	1



**40SOL**

Distance from fixture	40° Solite Lens							
	0.5	1.5	2.5	3.5	4.5	5.5	6.5	7.5
0.5	0	0	1	84	95	1	0	0
1.5	0	0	4	41	52	4	0	0
2.5	0	1	3	12	13	4	1	0
3.5	0	1	3	5	5	3	1	0
4.5	1	1	2	3	3	2	1	1
5.5	1	1	2	3	3	2	1	1
6.5	1	1	2	2	2	2	1	1



**65SOL**

Distance from fixture	65° Solite Lens							
	0.5	1.5	2.5	3.5	4.5	5.5	6.5	7.5
0.5	0	0	3	108	95	2	0	0
1.5	0	1	4	31	33	4	1	0
2.5	0	1	3	9	9	3	1	0
3.5	1	1	2	4	4	2	1	1
4.5	1	1	2	2	2	2	1	1
5.5	1	1	2	2	2	2	1	1
6.5	1	1	1	2	2	1	1	1



# Rook® 350

3.5" Round Wall Mount, Direct or Indirect, Dim-To-Warm



## PROJECT:

## TYPE:

### DIMMING COMPATIBILITY:

Amerlux® Rook fixtures are compatible with all major dimming protocols prevalent in the United States. Please see below for general compatibilities and wiring diagrams. Amerlux recommends testing your unique dimming configuration as the exact full configuration (Dimmer, Fixture Quantity, Voltage, etc) may affect dimming performance.

**--- NOTE: INFORMATION BELOW IS FOR WIRED DIMMERS ONLY. FOR WIRELESS DIMMERS, CONSULT FACTORY ---**

### TRIAC (Forward Phase) DIMMING (Standard)

Utilizes standard TRIAC dimmers that are in wide use in installations across the US. Best for retrofit applications where TRIAC dimmers are installed.

#### Notes:

- 120VAC or 277VAC\*
- Dims down to 5% light output (most cases)
- Consult Dimming manufacturer for installation instructions - DO NOT SHARE NEUTRALS!
- Must meet dimmer Minimum Load Requirements per dimming manufacturer

TRIAC Wiring Diagram

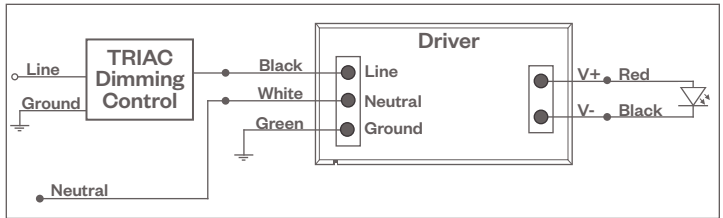

#### Compatible Dimmers†:

Wall Box (TRIAC 120VAC)	Central System
Lutron "Diva"	Lutron "GP" Panel
Lutron "Nova-T"	Lutron Grafik Eye QS
Lutron "Maestro"	
Lutron "Vareo"	
Lutron "Skylark"	

### ELV - Electronic Low Voltage (Reverse Phase) DIMMING (Standard)

Utilizes specialized "ELV" dimmers.

#### Notes:

- 120VAC or 277VAC\*
- Dims down to 5% light output (most cases)
- Consult Dimming manufacturer for installation instructions - DO NOT SHARE NEUTRALS!
- Must meet dimmer Minimum Load Requirements

ELV Wiring Diagram

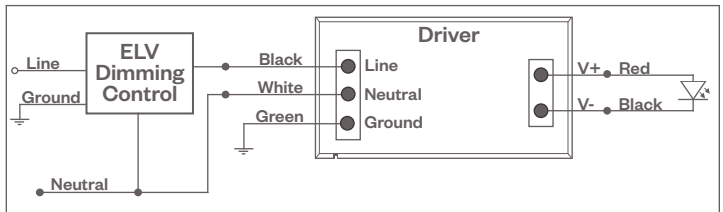

#### Compatible Dimmers†:

Wall Box (ELV 120VAC)	Wall Box (ELV 277VAC)	Central System
Lutron "Diva"	Leviton Revoir II AWSMT-E	Lutron "GP" Panel with PHPM-PA 120/277VAC
Lutron "Nova-T"		Lutron Grafik Eye QS with PHPM-PA 120/277VAC
Lutron "Maestro"		
Lutron "Vareo"		
Lutron "Skylark"		
Leviton "Surslide"		
Leviton "Vizio"		

#### Notes:

- \* Driver is 277VAC dimmable with appropriate dimmer (by others). All provided wiring diagrams show 120VAC wiring colors and method. Please refer to 277VAC dimmer manufacturer installation instructions for 277VAC wiring diagrams.
- † The absence of a dimmer from the lists above does not imply incompatibility. Please consult factory for compatibility inquiries.

# Rook® 350

3.5" Round Wall Mount, Direct or Indirect, Dim-To-Warm



## PROJECT:

## TYPE:

### DIMMING COMPATIBILITY:

Amerlux® Rook fixtures are compatible with all major dimming protocols prevalent in the United States. Please see below for general compatibilities and wiring diagrams. Amerlux recommends testing your unique dimming configuration as the exact full configuration (Dimmer, Fixture Quantity, Voltage, etc) may affect dimming performance.

**--- NOTE: INFORMATION BELOW IS FOR WIRED DIMMERS ONLY. FOR WIRELESS DIMMERS, CONSULT FACTORY ---**

### 0-10V - DIMMING (-0-10V Option)

Integrates into a variety of building management and daylighting controls

#### Notes:

- 120V or 277V\*
- Dims down to 1% light output
- Requires interface to turn off power to driver
- Consult Dimming manufacturer for installation instructions - DO NOT SHARE NEUTRALS!

0-10V Wiring Diagram

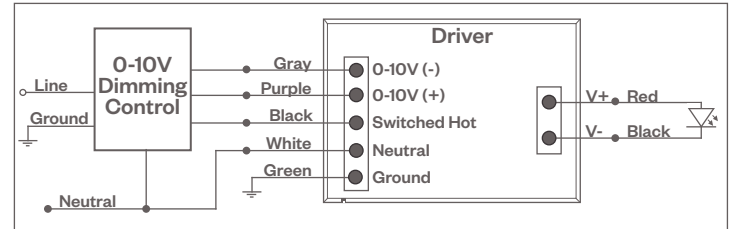

#### Compatible Dimmers\*:

##### Wall Box

Lutron "Diva" - DTVV with PP-120H Interface

Leviton Renoir II 0-10V

##### Central System

Lutron Grafik Eye with GRX-TVI Interface

#### Notes:

- \* Driver is 277VAC dimmable with appropriate dimmer (by others). All provided wiring diagrams show 120VAC wiring colors and method. Please refer to 277VAC dimmer manufacturer installation instructions for 277VAC wiring diagrams.
- † The absence of a dimmer from the lists above does not imply incompatibility. Please consult factory for compatibility inquiries.