

# HORNET® HIGH POWER

MULTIPLE RECESSED TRIMLESS 2 LIGHT LED INTERNATIONAL

I-HORNET-HP-RTLX-A14-2  
2LT LED

## APPLICATION:

Accent and display lighting for retail, commercial and hospitality environments

## CONSTRUCTION:

Stamped steel mounting frame  
Steel plaster frame  
Steel driver housing  
Extruded aluminum upper housing with knife-edge and mitered/welded corners  
Complete die-cast optical head construction  
No exposed wiring  
Powder coat paint

## MOUNTING:

For use in sheet rock ceilings

## LABELING:



For indoor use only

## OPTICS:

0-40° x 20° tilt, 360°+ rotation  
Available in a variety of beam spreads  
LED:  
Color Temp Options: 2200K, 2700K, 3000K, 3500K, 4000K  
CRI: 83 typ. (2700K, 3000K, 3500K, 4000K)  
90+ typ. (2200K, 2700K, 3000K)  
CrispWhite LED available (16w max)  
R9 Values: 11 (83CRI), 55 (90+CRI)  
Binning: 3 MacAdam  
Lumen Maintenance: >70% of initial lumens @ 50,000 hrs  
Lumen Output (18W, 3000K): SP 1369 lm (75 lm/W)  
CBCP (18W, 3000K): SP 12,215

## ELECTRICAL:

Electronic constant current LED driver, 240 input  
ELV and Triac dimming standard  
**This product complies with IEEE C62.41 for surge endurance up to 2.5KV. Amerlux recommends using additional surge protection with this unit (supplied by others), surge damage is not covered by warranty.**



## PROJECT:

TYPE:



Electrostatic sensitive device,  
observe precautions for  
handling

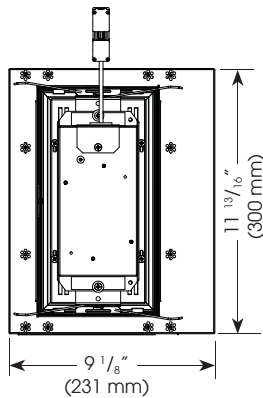

Ceiling Cut Out Dimension:  $9 \frac{1}{8}'' \times 11 \frac{13}{16}''$   
(141.3mm x 261.9mm)

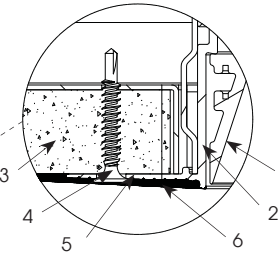
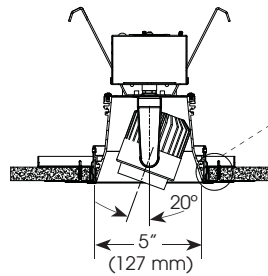
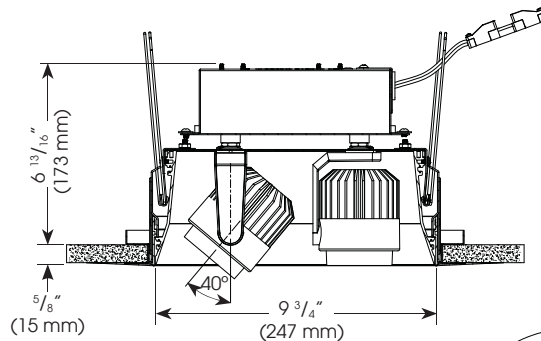

1. Recessed Extruded Housing
2. Aperture Plate
3. Ceiling 5/8"
4. Drywall Screw (by others)
5. Plaster Frame
6. Plaster Skim Coat (by others)

## ELECTRICAL

Electronic driver

	2x11W		2x16W		2x18W	
	System Watts	Amps	System Watts	Amps	System Watts	Amps
240v	22	0.09	32	0.13	36	0.15

## ORDERING INFORMATION:

Model	# Heads	Wattage	Lamp Type	Housing/ Head Finish	Voltage	Beam Spreads* Head 1 Head 2	Color Temp (CCT(K)-CRI)	Listing Code	Options/Accessories
I-HORNET-HP-RTLX-A14	2	11 16 18	LED	WT - white texture BT - black texture ST - silver texture - (other RAL)	240	SP SP NF NF MFL MFL FL FL WF WF VWF VWF LS LS	27 - 2700-83 30 - 3000-83 35 - 3500-83 40 - 4000-83 229 - 2200-90+ 279 - 2700-90+ 309 - 3000-90+ CRISP - CrispWhite (16W max)	CE	SNAH - snoot accessory holder, 1" length, matte black interior, specify exterior color (WT, BT, ST), accepts cross blade plus 2 additional forms of media AH - accessory holder, specify finish (WT, BT, ST), accepts 2 forms of media CB - cross blade, matte black finish, requires snoot HEX - hexcell louver (1/8" x 1/8"), requires SNAH or AH SOL - solite beam softening lens, requires SNAH or AH

\*NSP - narrow spot 12°, SP - spot 15°, NF - narrow flood 20°, MFL - medium flood 24°, FL - flood 28°, WF - wide flood 45°, VWF - very wide flood 60°, LS - linear spread 60°x10°

Example: I-HORNET-HP-RTLX-A14-2-18-LED-WT-240-FL-FL-30-CE

Cat #:

Amerlux reserves the right to change details that do not affect overall function and performance.

# HORNET® HIGH POWER

MULTIPLE RECESSED TRIMLESS 2 LIGHT LED INTERNATIONAL

I-HORNET-HP-RTLX-  
A14-2  
2LT LED



TYPE:



**FIXTURE DATA:** For 11W data, multiply by 0.62; For 16W data, multiply by 0.88

Complete photometric data (ies format) available upon request.

Note: Data per head

**18W LED**

SPOT (SP)  
DISTRIBUTION  
LTL #855377

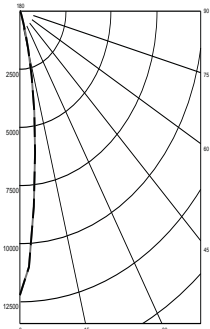

Candelas at Nadir	
Deg	Candela
0	12215
5	8436
15	1705
25	204
35	77
45	26

NARROW FLOOD (NF)  
DISTRIBUTION  
LTL #860527

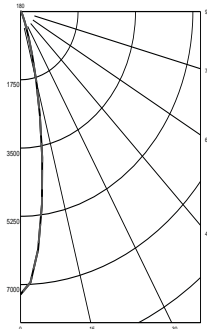

Candelas at Nadir	
Deg	Candela
0	7252
5	6128
15	1841
25	309
35	93
45	41

FLOOD (FL)  
DISTRIBUTION  
LTL # 860528

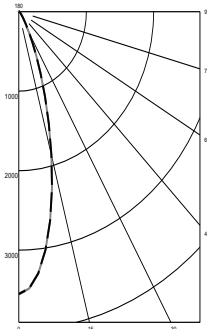

Candelas at Nadir	
Deg	Candela
0	3551
5	3304
15	1861
25	612
35	156
45	57

WIDE FLOOD (WF)  
DISTRIBUTION  
LTL # 860529

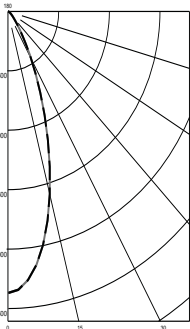

Candelas at Nadir	
Deg	Candela
0	2369
5	2268
15	1592
25	754
35	251
45	82

**APPLICATION DATA:**

**Notes and Definitions:**

Beam spread is to 50% center beam candlepower (CBCP).  
 D=Distance to floor or wall.  
 FC=Footcandles on floor or wall at center beam aiming location.  
 L=Effective Visual Beam length in feet (50% of maximum footcandle level).  
 W=Effective Visual Beam width in feet (50% of maximum footcandle level).  
 CB=Distance across or down to center beam location.

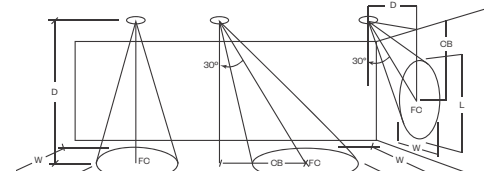

0° Aiming Angle  
Horizontal  
Footcandles



30° Aiming Angle  
Horizontal  
Footcandles



30° Aiming Angle  
Vertical  
Footcandles



60° Aiming Angle  
Vertical  
Footcandles

	0° Aiming Angle Horizontal Footcandles				30° Aiming Angle Horizontal Footcandles					30° Aiming Angle Vertical Footcandles					60° Aiming Angle Vertical Footcandles				
	D	FC	L	W	D	FC	L	W	CB	D	FC	L	W	CB	D	FC	L	W	CB
SPOT	5.0'	484	1.4	1.4	5.0'	313	1.8	1.5	3.0	3.0'	178	3.0	1.6	5.0	3.0'	630	1.6	1.1	2.0
	7.5'	216	2.0	2.0	7.5'	136	2.8	2.4	4.0	4.0'	105	3.8	2.1	6.0	4.0'	450	1.6	1.3	2.0
	10.0'	122	2.7	2.7	10.0'	76	3.7	3.2	6.0	5.0'	67	4.8	2.7	8.0	5.0'	298	2.0	1.6	3.0
	12.5'	78	3.4	3.4	12.5'	46	4.8	4.2	7.0	6.0'	47	5.9	3.2	9.0	6.0'	200	2.4	1.9	3.0
NARROW FLOOD	5.0'	289	1.7	1.7	5.0'	187	2.4	2.1	3.0	3.0'	127	3.3	1.8	4.0	3.0'	422	1.9	1.3	2.0
	7.5'	129	2.8	2.8	7.5'	86	3.5	3.1	4.0	4.0'	70	4.4	2.7	6.0	4.0'	298	1.9	1.5	2.0
	10.0'	73	3.6	3.6	10.0'	47	4.7	4.1	5.0	5.0'	47	5.3	3.2	7.0	5.0'	181	2.5	2.1	3.0
	12.5'	47	4.5	4.5	12.5'	31	5.8	5.2	7.0	6.0'	32	6.7	3.9	8.0	6.0'	133	2.8	2.5	3.0
FLOOD	5.0'	142	2.7	2.7	5.0'	92	3.4	3.1	3.0	3.0'	75	3.8	2.7	4.0	3.0'	232	2.3	1.7	2.0
	7.5'	63	3.9	3.9	7.5'	43	4.9	4.4	4.0	4.0'	44	4.9	3.3	5.0	4.0'	154	2.7	2.4	2.0
	10.0'	36	5.2	5.2	10.0'	25	6.4	5.8	5.0	5.0'	29	6.1	4.1	6.0	5.0'	95	3.4	3.0	2.0
	12.5'	23	6.5	6.5	12.5'	16	8.0	7.2	6.0	6.0'	20	7.4	5.1	7.0	6.0'	69	3.8	3.5	3.0
WIDE FLOOD	5.0'	95	3.2	3.2	5.0'	67	3.9	3.4	2.0	3.0'	63	3.7	2.8	3.0	3.0'	180	2.4	2.0	1.0
	7.5'	42	4.8	4.8	7.5'	30	5.7	5.3	3.0	4.0'	36	4.9	3.7	4.0	4.0'	105	3.2	2.9	2.0
	10.0'	24	6.4	6.4	10.0'	17	7.6	7.1	4.0	5.0'	23	6.1	4.8	5.0	5.0'	69	3.8	3.5	2.0
	12.5'	15	8.0	8.0	12.5'	11	9.6	8.9	5.0	6.0'	16	7.5	5.7	6.0	6.0'	47	4.7	4.3	3.0