

Hornet® HP

Square Lensed Downlight/ Wall Wash



Features

Hornet Lensed Downlights are the perfect choice for all general lighting needs. Available in Round or Square apertures, these fixtures meet the needs of commercial and hospitality markets. Optional Solite lensing provides whisper quiet aesthetics. Also available in knife-edge trimless, remodeler or millwork. Complementing Hornet Lens Wall Wash fixture available.

Product Overview

Type:	Recessed Square Lensed Downlight/Wall Wash
Wattage:	9, 12, 16, 23, 27, 30
Color Temp:	2200K, 2700K, 3000K, 3500K, 4000K, CRISP
CRI:	83 typ. (2700K, 3000K, 3500K, 4000K) 90+ typ. (2200K, 2700K, 3000K, 3500K, 4000K) CrispWhite & 3K Class A available
Dimming:	TRIAC & ELV (120/277VAC) - 5% Dim Lutron Hi-lume® H Series/EcoSystem - 1% dim with soft on, fade to black, 120/277VAC 0-10V (120/277VAC) - 1% Dim DALI (120/277VAC) - 1% Dim

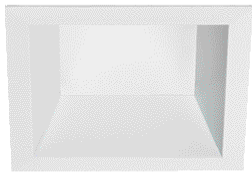

Downlight

PROJECT:

TYPE:



Trimless version



Millwork version



Wall Wash

Performance Chart

Watts	HDL-HP-SLD				HDL-HP-SLW		
	Delivered Lumens	LPW	CBCP	Color Temp	Delivered Lumens	LPW	Color Temp
9	832	92.4	1179	3000K-83	798	88.6	3000K-83
12	1109	92.4	1572	3000K-83	1063	88.6	3000K-83
16	1471	91.9	2085	3000K-83	1411	88.2	3000K-83
23	2133	94.5	3023	3000K-83	2045	90.6	3000K-83
27	2496	92.4	3537	3000K-83	2454	90.9	3000K-83
30	2773	92.4	3930	3000K-83	2659	88.6	3000K-83

Data is based on 3000K-83 IES files available on website

Data is based on 50SQL optic.

All wattage and LPW includes 2W thermal protector

Electrical Data

	9W		12W		16W	
	System Watts	Amps	System Watts	Amps	System Watts	Amps
120V	9.8	0.08	11.9	0.10	15.2	0.13
277V	9.8	0.04	11.9	0.04	15.2	0.06
	23W		27W		30W	
	System Watts	Amps	System Watts	Amps	System Watts	Amps
120V	22.8	0.19	27.3	0.23	32	0.27
277V	22.8	0.08	27.3	0.10	32	0.12

Electronic constant current LED driver

Includes thermal protector, 2W power consumption



5 year limited warranty
AMERLUX LED

Title 24
Compliant

Hornet® HP

Square Lensed Downlight/Wall Wash



PROJECT:

TYPE:

Housing/Frame Ordering Information

1	2	3	4	5	6
<p>1 Model For New Construction HDL-HP-S-NC-A17* (New Construction) HDL-HP-S-CP-A17* (Chicago Plenum (CEEA) housing) HDL-HP-S-IC-A17** (Insulated Ceiling/air tight, 16W max)</p> <p>For Existing Ceilings HDL-HP-S-REM-A17* (Remodeler)</p>	<p>2 Style T - trimmed TL - trimless MWK^{R†} - millwork (for 1/2" - 11/16" ceiling thickness)</p> <p>^R Not available for use with Remodeler model [†] For SLD Trim consult factory for use in ceilings thicker than 11/16"; For SLW Trim max ceiling thickness is 11/16"</p>	<p>3 Wattage 9 12 16* 23** 27** 30**</p> <p>** Not available for use with IC housing</p>	<p>4 Voltage 120 277 120/277 (for use with IC housing only)</p>	<p>5 Driver (for non-dimming, select LE/TE option) LE/TE* - TRIAC/ELV dimming HILUME-H-ECO - Lutron Hi-lume® H Series, EcoSystem, 1% dim with soft on, fade to black 0-10V* - 0-10V dimming, 1% dim DALI - DALI dimming, 1% dim</p>	<p>6 Options/Accessories EM - emergency battery pack with remote test switch (not available for use with REM, CP or IC options) HB49 - hanger bars from min 29" to max 49" (not available for use with REM options)</p>

Trim Ordering Information

1	2	3	4	5	6																														
<p>1 Model HDL-HP-SLD-A17* (lensed downlight) HDL-HP-SLW-A17* (lensed wall wash)</p>	<p>2 Style T - trimmed TL - trimless MWK - millwork (SLW trim max 3/4" thick millwork)</p>	<p>3 Finish</p> <table border="0"> <tr> <td><u>Trimmed</u></td> <td><u>Trimless/Millwork</u></td> </tr> <tr> <td>MBW - matte black, white flange</td> <td>MB - matte black</td> </tr> <tr> <td>MWW - matte white, white flange</td> <td>MW - matte white</td> </tr> <tr> <td>SLVW - matte silver, white flange</td> <td>SLV - matte silver</td> </tr> <tr> <td>MBB - matte black, black flange</td> <td></td> </tr> <tr> <td>SLVS - matte silver, silver flange</td> <td></td> </tr> </table>	<u>Trimmed</u>	<u>Trimless/Millwork</u>	MBW - matte black, white flange	MB - matte black	MWW - matte white, white flange	MW - matte white	SLVW - matte silver, white flange	SLV - matte silver	MBB - matte black, black flange		SLVS - matte silver, silver flange		<p>4 Beam Spreads (not required with SLW version) 30SOL - 30° beam with solite lens 50SOL - 50° beam with solite lens 65SOL - 65° beam with solite lens 75SAT - 75° beam with satin ice lens</p>	<p>5 Color Temp</p> <table border="0"> <tr> <td>83 CRI</td> <td>90+ CRI</td> <td></td> </tr> <tr> <td>27 - 2700K-83</td> <td>229 - 2200K-90+</td> <td>CRISP* - CrispWhite</td> </tr> <tr> <td>30 - 3000K-83</td> <td>279* - 2700K-90+</td> <td>3CLA* - 3K Class A</td> </tr> <tr> <td>35 - 3500K-83</td> <td>309* - 3000K-90+</td> <td></td> </tr> <tr> <td>40 - 4000K-83</td> <td>359 - 3500K-90+</td> <td></td> </tr> <tr> <td></td> <td>409 - 4000K-90+</td> <td></td> </tr> </table> <p>* Not available for 27W & 30W</p>	83 CRI	90+ CRI		27 - 2700K-83	229 - 2200K-90+	CRISP* - CrispWhite	30 - 3000K-83	279* - 2700K-90+	3CLA* - 3K Class A	35 - 3500K-83	309* - 3000K-90+		40 - 4000K-83	359 - 3500K-90+			409 - 4000K-90+		<p>6 Options/Accessories WET - wet location (only available for use with trimmed style)</p>
<u>Trimmed</u>	<u>Trimless/Millwork</u>																																		
MBW - matte black, white flange	MB - matte black																																		
MWW - matte white, white flange	MW - matte white																																		
SLVW - matte silver, white flange	SLV - matte silver																																		
MBB - matte black, black flange																																			
SLVS - matte silver, silver flange																																			
83 CRI	90+ CRI																																		
27 - 2700K-83	229 - 2200K-90+	CRISP* - CrispWhite																																	
30 - 3000K-83	279* - 2700K-90+	3CLA* - 3K Class A																																	
35 - 3500K-83	309* - 3000K-90+																																		
40 - 4000K-83	359 - 3500K-90+																																		
	409 - 4000K-90+																																		

* Title 24 Compliant

† The "A" refers to the sequential revision in a year and "XX" refers to the year of update. Updates coincide with improved performance while not changing the overall fixture aesthetic and are reflected in the published performance data. Please contact your Amerlux representative for explanations of changes.

Hornet® HP

Square Lensed Downlight/Wall Wash



PROJECT:

TYPE:

Specifications

Application

Retail and commercial ambient or wall wash lighting

Construction

- 20 ga. galvanized steel frame
- 18 ga. galvanized steel splice housing and hanger brackets (not for Remodeler version)
- Cast aluminum plaster frame with perforated face (for trimless version only)
- Die-cast optical housing and trim
- Die-cast heat sink

Optical

Lens Options (for SLD version):

- Satin Ice lens for maximum source concealment and wide distribution with a visually "hotter" aperture.
- Solite lens for maximum efficacy and a visually quieter aperture. 30°, 50° and 65° beam spread options. Visually best with SLV reflector finish.

Beam spreads (for SLD version):

- 30SQL - 30° beam with solite lens
- 50SQL - 50° beam with solite lens
- 65SQL - 65° beam with solite lens
- 75SAT - 75° beam with satin ice lens

Wall Wash:

Engineered nano technology lens provides high transmission while concealing LED image

LED

Color Temp Options:

- 2200K, 2700K, 3000K, 3500K, 4000K
- CRI: 83 typ. (2700K, 3000K, 3500K, 4000K)
- 90+ typ. (2200K, 2700K, 3000K, 3500K, 4000K)
- CrispWhite* and Class A** 3000K LEDs available

R9 Values: 11 (83 CRI), 55 (92 CRI)

Binning: 3 MacAdam (SDCM)

Life: 50,000+ hrs, > 70% of initial lumens at 50,000 hrs

**CrispWhite: CrispWhite Technology delivers the warmth of colors expected from a high 90 CRI solution but also creates the natural crisp white color that is pleasing to the eye. It creates the most impactful lighting ever available, by revealing the richest whites and vibrant colors that pop.*

***Class A LED: Class A LED's have a CRI > 80 and a GAI > 80. CRI defines color "Naturalness" and GAI defines color "Saturation." Both being high delivers rich colors and pure whites.*

Electrical

Wattage: 9, 12, 16, 23, 27, 30

Electronic constant current LED driver, 120/277VAC input

This product complies with IEEE C62.41 for surge endurance up to 2.5KV. Amerlux® recommends using additional surge protection with this unit (supplied by others), surge and over voltage damage is not covered under warranty.

Note: Drivers are universal but thermal protector is voltage specific

Drivers

- LE/TE - Leading Edge, TRIAC, forward phase/Trailing Edge, ELV, reverse phase
- 0-10V, Lutron and DALI systems available
- See pages 10-12 for more dimming information

Finish

- Powder coat paint/wet paint
- Consult factory for custom finishes

Mounting

- 26" Hanger bars included (except for Remodeler versions)
- Optional **HB49** - hanger bars from min 29" to max 49" available

Trimmed Fixture:

For use in grid or sheetrock ceilings, 5/8" - 2" max (1" max for SLW trims) standard

Trimless Fixture:

For use in sheetrock ceilings, max ceiling thickness 5/8"

Millwork Fixture:

Millwork extension collars are based on ceiling material specifications and thickness. Provides flush trim appearance level with ceiling material.

For **SLD** trim - ceiling thickness 1/2" - 11/16", consult factory for use in thicker ceilings.

For **SLW** trim - max ceiling thickness is 11/16".

Not available for use with Remodeler model

Certifications

- CSA damp as tested to UL 1598 standards
- CP - Chicago Plenum (CCEA) option
- IC/AT rated (optional, 16W only)
- Title 24 Compliant (see ordering page for options that apply)
- Damp location
- Wet location option

Warranty

5 year limited warranty

Emergency Battery Pack (EM)

Powers fixture at 5.1 watts (approx. 400 Lm) for 90 minutes (not for use with REM, CP or IC/AT versions)

Hornet[®] HP

Square Lensed Downlight/Wall Wash



PROJECT:

TYPE:

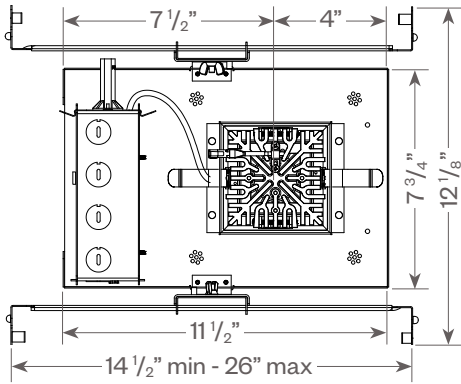

Optional CP or IC/AT housing

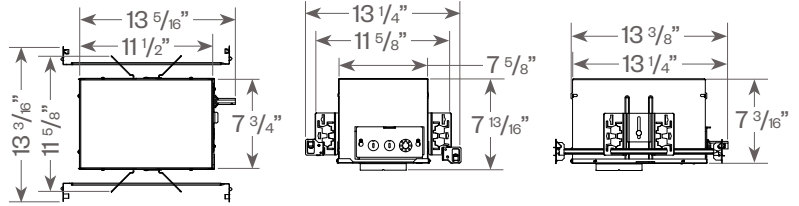

Emergency Battery Pack (EM) option

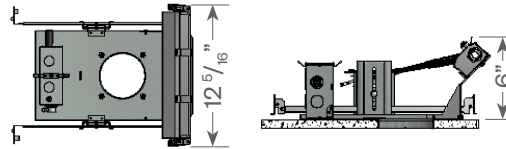

Hornet HP Square Lensed Downlight:

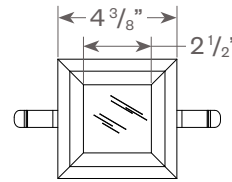
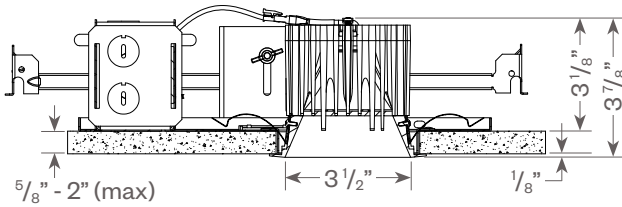

Ceiling cut out: 4" sq.

Hornet HP Square Lensed Wall Wash:

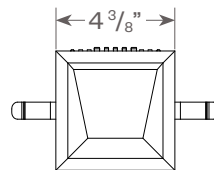
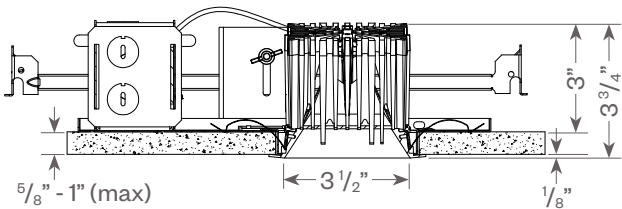

Ceiling cut out: 4" sq.

Hornet[®] HP

Square Lensed Downlight/Wall Wash



PROJECT:

TYPE:

Hornet HP Square Lensed Downlight:

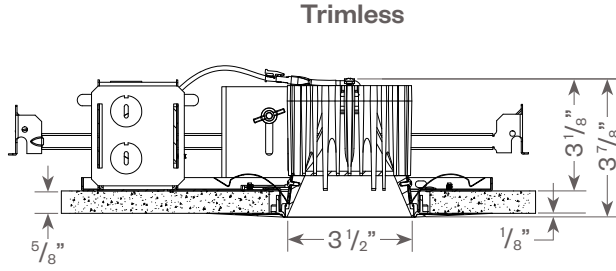

Trimless Ceiling cut out: 4 1/2" sq.

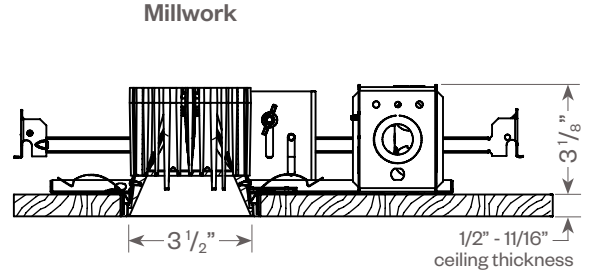
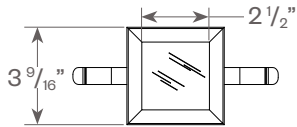

Millwork Ceiling cut out: 4" sq.

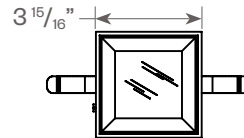

Hornet HP Square Lensed Wall Wash:

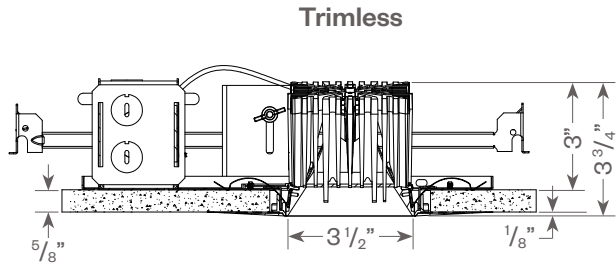

Trimless Ceiling cut out: 4 1/2" sq.

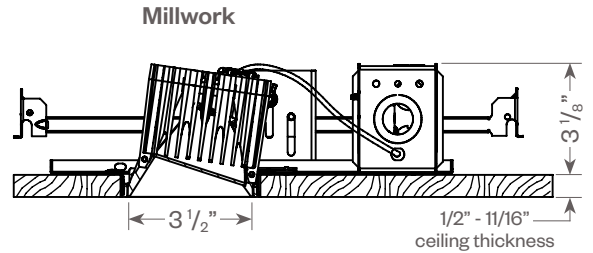
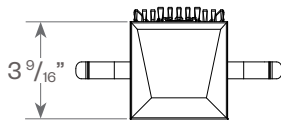

Millwork Ceiling cut out: 4" sq.

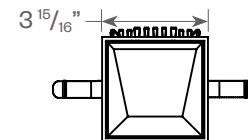

Plaster Frame Installation Detail (for trimless fixture only)

1. Reflector Trim
2. Aperture plate
3. Ceiling 5/8"
4. Cast Aluminum Plaster Frame
5. Plaster Skim Coat (by others)
6. 6-32 Type F Thread Cutting Screw

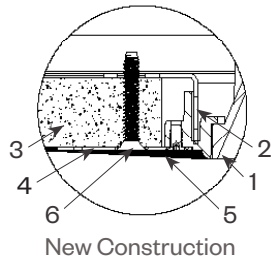

Millwork Detail

1. Reflector Trim
2. Millwork Ring
3. Aperture Plate
4. Wood Ceiling 2" Max
5. Extension collar (see ordering information for ceiling thicknesses)
6. 1/16" required for trim to be flush with ceiling

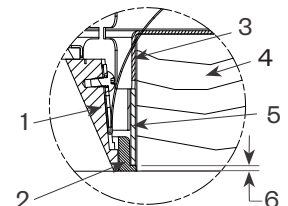

Hornet[®] HP

Square Lensed Downlight/Wall Wash



PROJECT:

TYPE:

Remodeler:

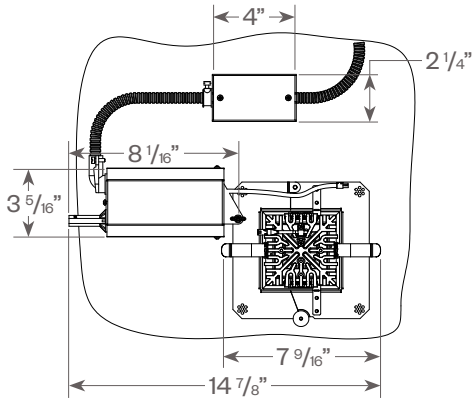

Hornet HP Square Lensed Downlight Remodeler:

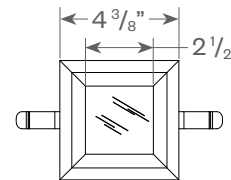
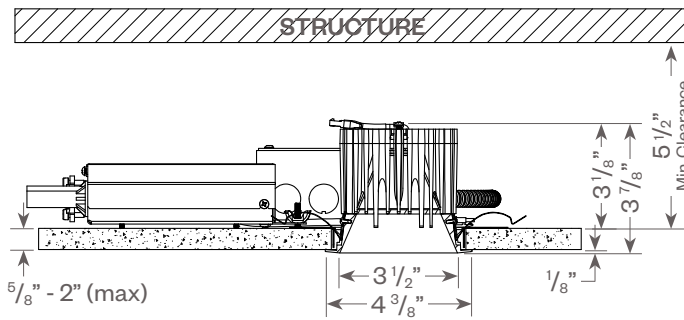

Ceiling cut out: 4" sq.

Hornet HP Square Lensed Wall Wash Remodeler:

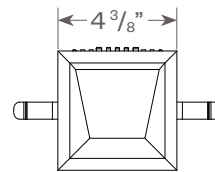
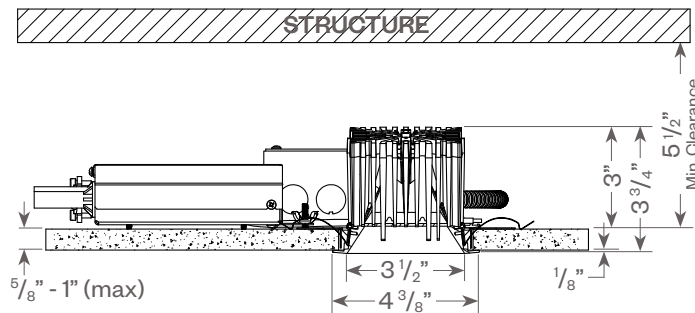

Ceiling cut out: 4" sq.

Hornet[®] HP

Square Lensed Downlight/Wall Wash



PROJECT:

TYPE:

Hornet HP Square Lensed Downlight Remodeler:

Trimless

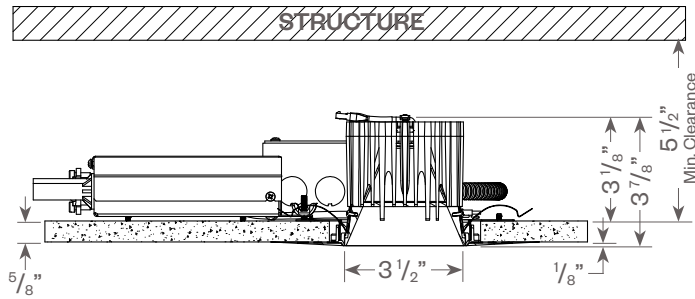

Trimless Ceiling cut out: 4 1/2" sq.

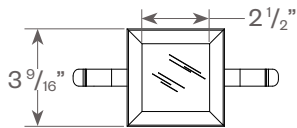

Hornet HP Square Lensed Wall Wash Remodeler:

Trimless

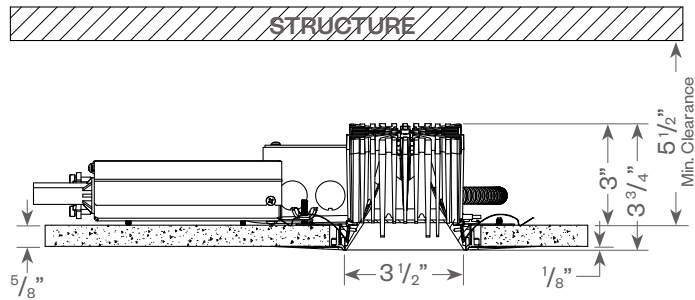

Trimless Ceiling cut out: 4 1/2" sq.

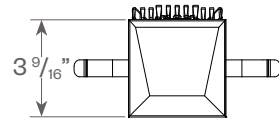

Plaster Frame Installation Detail (for trimless fixture only)

1. Reflector Trim
2. Aperture plate
3. Ceiling 5/8"
4. Cast Aluminum Plaster Frame
5. Plaster Skim Coat (by others)
6. 6-32 Type F Thread Cutting Screw

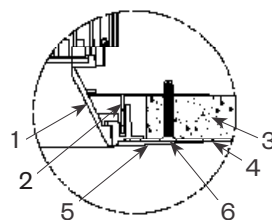

Remodeler

Hornet® HP

Square Lensed Downlight/Wall Wash



PROJECT:

TYPE:

Hornet HP Square Lensed Downlight:

FIXTURE DATA: (Complete photometric data (.ies format) available upon request)

MULTIPLYING FACTORS: (Multiplying Factor is based on 3000K-83 120V IES file on website)

Wattage:	9W	12W	16W	23W	27W	30W
Factor:	0.39	0.52	0.69	1.0	1.2	1.3

CCT:	2700K-83	3000K-83	3500K-83	4000K-83
Factor:	0.96	1.0	1.02	1.04

CCT:	2200K-90+	2700K-90+	3000K-90+	3500K-90+	4000K-90+	CRISP	3CLA
Factor:	0.66	0.83	0.86	0.90	0.93	0.65	0.70

23W LED, 3000K-83

30° Solite Lens
LTL # 13408034.06
Lumens: 2080 lm; 92.1 lm/W

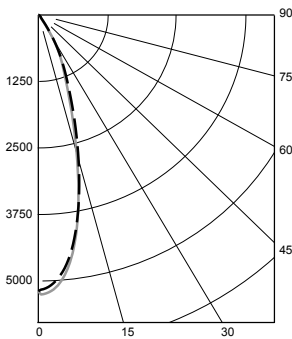

Candelas at Nadir

Deg	Candela
0	5191
5	4959
15	2524
25	955
35	141
45	58

50° Solite Lens
LTL # 13408034.07
Lumens: 2133 lm; 94.5 lm/W

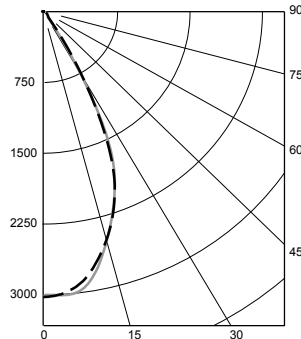

Candelas at Nadir

Deg	Candela
0	3023
5	3010
15	2495
25	1604
35	180
45	66

65° Solite Lens
LTL # 13408034.08
Lumens: 2073 lm; 91.9 lm/W

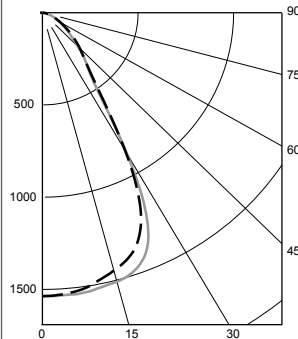

Candelas at Nadir

Deg	Candela
0	1537
5	1535
15	1509
25	1305
35	479
45	267

75° Satin Ice Lens
LTL # 13408034.09
Lumens: 1925 lm; 85.9 lm/W

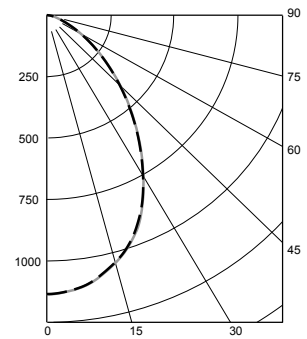

Candelas at Nadir

Deg	Candela
0	1135
5	1125
15	1043
25	880
35	636
45	410

Application Data:

Notes and Definitions:

- Beam spread is to 50% center beam candlepower (CBCP).
- D=Distance to floor or wall.
- FC=Footcandles on floor or wall at center beam aiming location.
- L=Effective Visual Beam length in feet (50% of maximum footcandle level).
- W=Effective Visual Beam width in feet (50% of maximum footcandle level).
- CB=Distance across or down to center beam location.

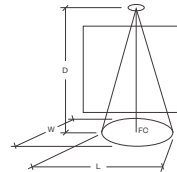

30° Solite Lens
0° Aiming Angle
Horizontal Footcandles

D	FC	L	W
5.0'	208	2.6	2.6
7.5'	93	3.7	3.8
10.0'	52	5.0	5.2
12.5'	34	6.3	6.4

50° Solite Lens
0° Aiming Angle
Horizontal Footcandles

D	FC	L	W
5.0'	122	4.1	4.1
7.5'	54	6.1	6.1
10.0'	31	8.2	8.2
12.5'	20	10.3	10.2

65° Solite Lens
0° Aiming Angle
Horizontal Footcandles

D	FC	L	W
5.0'	62	5.2	5.1
7.5'	28	7.9	7.7
10.0'	16	10.6	10.4
12.5'	10	13.4	13.2

75° Satin Ice Lens
0° Aiming Angle
Horizontal Footcandles

D	FC	L	W
5.0'	44	5.5	5.5
7.5'	20	8.1	8.1
10.0'	12	10.9	10.9
12.5'	8	14.1	14.0

Hornet[®] HP

Square Lensed Downlight/Wall Wash



PROJECT:

TYPE:

Hornet HP Square Lensed Wall Wash:

FIXTURE DATA: (Complete photometric data (.ies format) available upon request)

MULTIPLYING FACTORS: (Multiplying Factor is based on 3000K-83 120V IES file on website)

Wattage:	9W	12W	16W	23W	27W	30W
Factor:	0.39	0.52	0.69	1.0	1.2	1.3

CCT:	2700K-83	3000K-83	3500K-83	4000K-83
Factor:	0.96	1.0	1.02	1.04

CCT:	2200K-90+	2700K-90+	3000K-90+	3500K-90+	4000K-90+	CRISP	3CLA
Factor:	0.66	0.83	0.86	0.90	0.93	0.65	0.70

23W 3000K-83

Wall Wash
LTL # 13408034.10
Lumens: 2045 lm

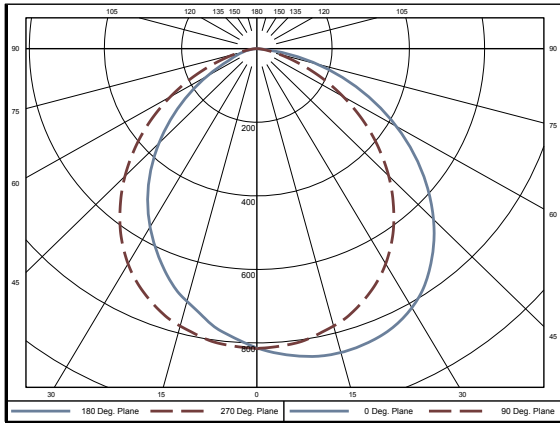

ZONAL LUMEN SUMMARY

Zone	Lumens	%Fixt
0-40	1029	50.3
0-60	1739	85.0
0-90	2045	100.0
90-180	0	0.0

Luminaire Efficacy: 90.6 Lm/W

Application Data:

Footcandles on Wall

Footcandles are average and rounded off.
Data for multiple units are based on a minimum of five units.

1.5 Feet from Wall

		← 1.5' → ← 1.5' →				
Distance from ceiling	0.5'	105	109	110	109	105
	1.5'	170	180	183	180	170
	2.5'	116	127	130	127	117
	3.5'	69	76	78	76	70
	4.5'	42	45	48	47	43
	5.5'	29	31	32	31	29
	6.5'	21	22	23	22	21
	7.5'	16	17	17	17	16

1.5 Feet from Wall

		← 2' → ← 2' →						
Distance from ceiling	0.5'	78	87	79	88	77	87	77
	1.5'	131	141	137	143	136	142	130
	2.5'	92	99	101	103	101	99	93
	3.5'	55	61	63	64	63	61	57
	4.5'	35	38	40	41	41	39	36
	5.5'	24	27	28	28	28	27	25
	6.5'	18	20	20	21	21	20	19
	7.5'	14	15	16	16	16	16	15

2 Feet from Wall

		← 2' → ← 2' →						
Distance from ceiling	0.5'	44	50	48	51	49	50	46
	1.5'	96	104	104	107	105	105	97
	2.5'	88	95	98	99	98	96	88
	3.5'	61	66	69	70	69	67	61
	4.5'	41	45	47	48	47	45	41
	5.5'	29	32	33	34	33	32	29
	6.5'	22	23	25	25	25	23	22
	7.5'	17	18	19	19	19	18	17

PROJECT:

TYPE:

DIMMING COMPATIBILITY:

Amerlux[®] Hornet fixtures are compatible with all major dimming protocols prevalent in the United States. Please see below for general compatibilities and wiring diagrams. Amerlux recommends testing your unique dimming configuration as the exact full configuration (Dimmer, Fixture Quantity, Voltage, etc) may affect dimming performance.

--- NOTE: INFORMATION BELOW IS FOR WIRED DIMMERS ONLY. FOR WIRELESS DIMMERS, CONSULT FACTORY ---

TRIAC (Forward Phase) DIMMING (Standard)

Utilizes standard TRIAC dimmers that are in wide use in installations across the US. Best for retrofit applications where TRIAC dimmers are installed.

Notes:

- 120VAC or 277VAC*
- Dims down to 5% light output (most cases)
- Consult Dimming manufacturer for installation instructions - DO NOT SHARE NEUTRALS!
- Must meet dimmer Minimum Load Requirements per dimming manufacturer

TRIAC Wiring Diagram

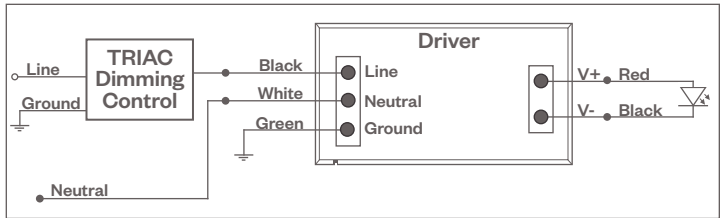

Compatible Dimmers†:

Wall Box (TRIAC 120VAC)	Central System
Lutron "Diva"	Lutron "GP" Panel
Lutron "Nova-T"	Lutron Grafik Eye QS
Lutron "Maestro"	
Lutron "Vareo"	
Lutron "Skylark"	

ELV - Electronic Low Voltage (Reverse Phase) DIMMING (Standard)

Utilizes specialized "ELV" dimmers.

Notes:

- 120VAC or 277VAC*
- Dims down to 5% light output (most cases)
- Consult Dimming manufacturer for installation instructions - DO NOT SHARE NEUTRALS!
- Must meet dimmer Minimum Load Requirements

ELV Wiring Diagram

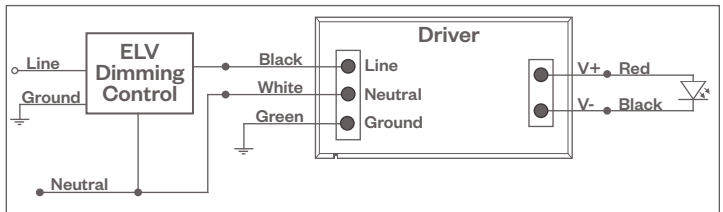

Compatible Dimmers†:

Wall Box (ELV 120VAC)	Wall Box (ELV 277VAC)	Central System
Lutron "Diva"	Leviton Revoir II AWSMT-E	Lutron "GP" Panel with PHPM-PA 120/277VAC
Lutron "Nova-T"		Lutron Grafik Eye QS with PHPM-PA 120/277VAC
Lutron "Maestro"		
Lutron "Vareo"		
Lutron "Skylark"		
Leviton "Surslide"		
Leviton "Vizio"		

Notes:

- * Driver is 277VAC dimmable with appropriate dimmer (by others). All provided wiring diagrams show 120VAC wiring colors and method. Please refer to 277VAC dimmer manufacturer installation instructions for 277VAC wiring diagrams.
- † The absence of a dimmer from the lists above does not imply incompatibility. Please consult factory for compatibility inquiries.

Hornet® HP

Square Lensed Downlight/Wall Wash



PROJECT:

TYPE:

DIMMING COMPATIBILITY:

Amerlux® Hornet fixtures are compatible with all major dimming protocols prevalent in the United States. Please see below for general compatibilities and wiring diagrams. Amerlux recommends testing your unique dimming configuration as the exact full configuration (Dimmer, Fixture Quantity, Voltage, etc) may affect dimming performance.

--- NOTE: INFORMATION BELOW IS FOR WIRED DIMMERS ONLY. FOR WIRELESS DIMMERS, CONSULT FACTORY ---

0-10V DIMMING

Integrates into a variety of building management and daylighting controls

Notes:

- 120VAC or 277VAC*
- Dims down to 1% light output
- Requires interface to turn off power to driver
- Consult Dimming manufacturer for installation instructions - DO NOT SHARE NEUTRALS!

0-10V Wiring Diagram

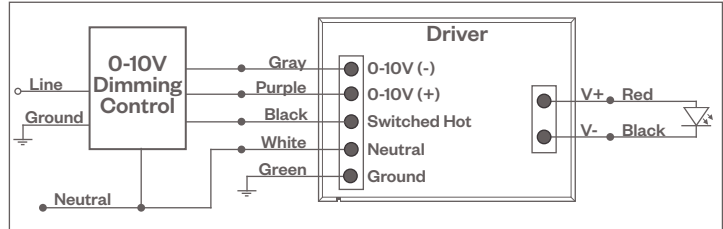

Compatible Dimmers*:

Wall Box

Lutron "Diva" - DTVV with PP-120H Interface

Leviton Renoir II 0-10V

Central System

Lutron Grafik Eye with GRX-TV1 Interface

LUTRON H-SERIES / ECOSYSTEM DIMMING

Integrates into Lutron EcoSystem building management

Notes:

- 120VAC or 277VAC*
- Dims down to 1% light output
- EcoSystem Control
- Consult Dimming manufacturer for installation instructions - DO NOT SHARE NEUTRALS!

HILUME-H-ECO, HILUME-5-ECO

EcoSystem Digital Control Wiring Diagram

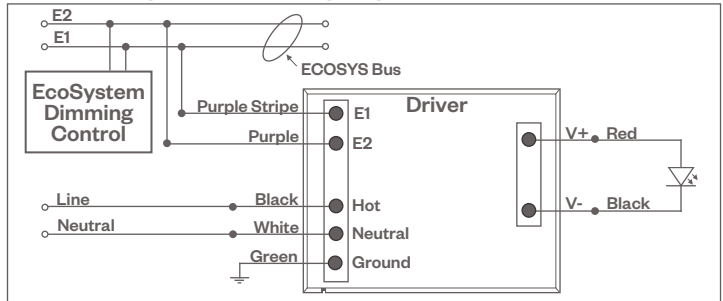

Compatible Dimmers*:

Lutron ECO System

Pow Pak Dimming Modules
Energj Savr Node
Grafik Eye QS/Homeworks
QS Control Unit
Quantum Hub
Homeworks QS/My Room

Central System

Lutron EcoSystem compatible controls

DALI DIMMING

Digital control protocol allows individual fixture control

Notes:

- 120VAC - 277VAC*
- Dims down to 1% light output in most cases

DALI Wiring Diagram

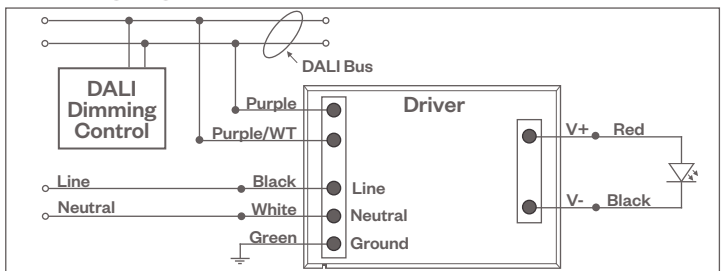

Compatible Dimmers*:

Wall Box (3-Wire Fluorescent)

Leviton CD250 Controller

Central System

Dynalite
Fifth Light

Notes:

- * Driver is 277VAC dimmable with appropriate dimmer (by others). All provided wiring diagrams show 120VAC wiring colors and method. Please refer to 277VAC dimmer manufacturer installation instructions for 277VAC wiring diagrams.
- † The absence of a dimmer from the lists above does not imply incompatibility. Please consult factory for compatibility inquiries.

PROJECT:

TYPE:

EMERGENCY DIMMING (-EM OPTION)

Wiring Diagram

