

HORNET® HP DOWNLIGHT

3.5" ROUND DOWNLIGHT TRIMLESS LED INTERNATIONAL

I-HDL-HP-RD-A14-TL
LED



APPLICATION:

Retail, commercial & hospitality accent/display lighting

CONSTRUCTION:

Die-cast aluminum trim ring
Die-cast optical head construction
Cast aluminum plaster frame with perforated face
Spring steel retaining clips
Painted finishes include matte white and optical matte black

ELECTRICAL:

Electronic constant current LED driver, 240v
ELV & Triac dimming standard

This product complies with IEEE C62.41 for surge endurance up to 2.5KV. Amerlux® recommends using additional surge protection with this unit (supplied by others), surge damage is not covered by warranty.

OPTICS:

Available in a variety of beam spreads
LED:

Color Temp Options: 2200K, 2700K, 3000K, 3500K, 4000K
CRI: 83 typ. (2700K, 3000K, 3500K, 4000K)
90+ typ. (2200K, 2700K, 3000K)

Optional Amerlux CrispWhite technology (16W max)

R9 Value: 11 (83CRI), 55 (90+CRI)

Binning: 3 MacAdam (SDMC)

Lumen Maintenance: >70% of initial lumens @ 50,000 hrs

Lumen Output (at 3000K):

16W: SP 1191 typ.	18W: SP 1323 typ.
NF 1112 typ.	NF 1236 typ.
FL 1067 typ.	FL 1185 typ.
WF 1011 typ.	WF 1123 typ.

LABELING:



For indoor use only

PROJECT:

TYPE:

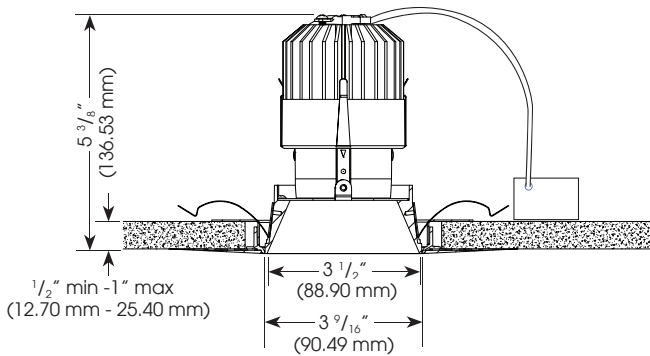

Ceiling Cut Out Dimension: 4 1/2" (114.3 mm)

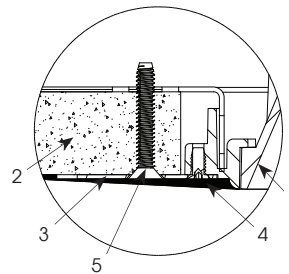

1. Reflector Trim
2. Ceiling 1/2" (1" Max.)
3. Cast Aluminum Plaster Frame
4. Plaster Skim Coat (By Others)
5. #6 Screw (by others)

Electrostatic sensitive device,
observe precautions for
handling

114.3 mm

ELECTRICAL

Electronic driver

	11W		16W		18W	
	System Watts	Amps	System Watts	Amps	System Watts	Amps
240v	11	0.05	16	0.07	18	0.08

ORDERING INFORMATION:

Model	Wattage	Lamp Type	Voltage	Aperture Finish	Beam Spread	Color Temp (CCT-CRI)	Listing Code	Options/Accessories	
I-HDL-HP-RD-A14-TL	11	LED	240	MB - matte black MW - matte white SLV - matte silver	SP - spot, 15°	27 - 2700K-83	CE	HEX - hexcell louver	
	16				NF - narrow flood, 20°	30 - 3000K-83		SOL - solite beam softening lens	
					18	MFL - medium flood, 24°		35 - 3500K-83	DALI - DALI driver
	FL - flood, 28°					40 - 4000K-83			
	WF - wide flood, 45°				229 - 2200K-90+ 279 - 2700K-90+ 309 - 3000K-90+	VWF - very wide flood, 60°			
	LS - linear spread, 60° x 10°								
									CRISP - CrispWhite (16W max)
									3CLA - 3K Class A

Example: I-HDL-HP-RD-A14-TL-18-LED-240-MB-FL-30-CE

Cat #:

Amerlux reserves the right to change details that do not affect overall function and performance.



3 year limited warranty
AMERLUX INTERNATIONAL
(see website for details)

HORNET® HP DOWNLIGHT

3.5" ROUND DOWNLIGHT TRIMLESS LED INTERNATIONAL

I-HDL-HP-RD-
A14-TL
LED



TYPE:



FIXTURE DATA: For 11W data, multiply by 0.62; For 16W data, multiply by 0.88

Complete photometric data (ies format) available upon request.

CCT Conversion Factor: 2700K-83 = 0.96; 3500K-83 = 1.02; 4000K-83 = 1.04; 2200K-90+ = 0.71; 2700-90+ = 0.80; 3000K-90+ = 0.83; CRISP = 0.65; 3CLA = 0.75

18W LED 3000K-83

SPOT
DISTRIBUTION
LTL # 818231

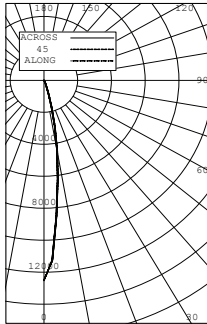

Candelas at Nadir	
Deg	Candela
0	12508
5	8495
15	1754
25	190
35	32
45	3

NARROW FLOOD
DISTRIBUTION
LTL # 818232

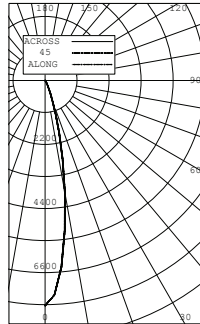

Candelas at Nadir	
Deg	Candela
0	7734
5	6428
15	1866
25	277
35	45
45	4

FLOOD
DISTRIBUTION
LTL # 818234

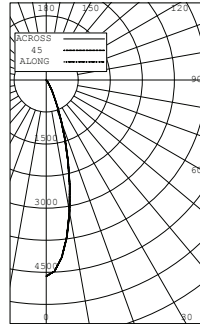

Candelas at Nadir	
Deg	Candela
0	4591
5	4168
15	1966
25	470
35	72
45	4

WIDE FLOOD
DISTRIBUTION
LTL # 818235

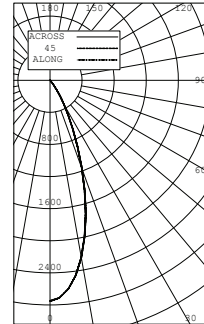

Candelas at Nadir	
Deg	Candela
0	2751
5	2614
15	1719
25	676
35	141
45	7

APPLICATION DATA:

Notes and Definitions:

Beam spread is to 50% center beam candlepower (CBCP).
 D=Distance to floor or wall.
 FC=Footcandles on floor or wall at center beam aiming location.
 L=Effective Visual Beam length in feet (50% of maximum footcandle level).
 W=Effective Visual Beam width in feet (50% of maximum footcandle level).
 CB=Distance across or down to center beam location.

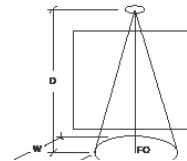

0° Aiming Angle
Horizontal
Footcandles

	D	FC	L	W
SPOT	5.0'	483	1.4	1.4
	7.5'	223	1.9	1.9
	10.0'	124	2.7	2.7
	12.5'	80	3.3	3.3
NARROW FLOOD	5.0'	231	2.1	2.1
	7.5'	120	2.9	2.9
	10.0'	71	3.7	3.7
	12.5'	47	4.6	4.6
FLOOD	5.0'	150	2.7	2.7
	7.5'	74	3.6	3.6
	10.0'	43	4.8	4.8
	12.5'	28	5.8	5.8
WIDE FLOOD	5.0'	97	3.2	3.2
	7.5'	46	4.6	4.6
	10.0'	27	6.1	6.1
	12.5'	17	7.5	7.5