

Passo SQ

6" Directional LED
Recessed Wall Luminaire

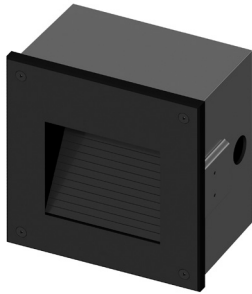

PSCD6

Features

The Passo family of luminaires includes high quality, architecturally relevant fixtures suitable for use in both outdoor or indoor applications. All members of the Passo family feature an independently sealed optical chamber and fully potted driver. These features are especially beneficial in exterior applications as they help compensate for the challenges in getting a good seal between a pre-installed back box and the faceplate as well as those challenges in fully sealing the conduit system. Each luminaire is available in a choice of three output levels to help tailor the desired illuminance to the project and a standard 0-10V dimmable driver allows even further flexibility.

Product Overview

Type:	Recessed Wall Luminaire
Wattage:	up to 16.2W
Lumen Output :	up to 188 lm
Color Temp:	2700K, 3000K, 4000K, Amber
Dimming:	0-10V down to 10%

PROJECT:

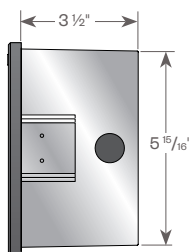
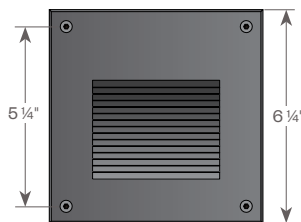

TYPE:

Application:

Designed for new construction in interior or exterior hollow walls or poured concrete.

Construction:

- Die-cast aluminum housing with protective powdercoat finish
- Sealed die-cast aluminum internal optical chamber
- Die-cast aluminum faceplate
- 1/8" tempered Solite™ lens

Driver:

- Drive Current (100, 175 or 350mA)
- 2.5kv surge protection
- Fully potted
- Input voltage 120V-277V auto-sensing
- 0-10V dimmable down to 10%

ETL listed, suitable for wet locations.

Optics:

Individually sealed optical chamber insures LEDs are secure independent of the installation of the back box.

Finish:

Premium quality thermoset polyester powdercoat faceplate for a durable finish.



5 year limited warranty
AMERLUX LED



Passo SQ

6" Directional LED Recessed Wall Luminaire



PROJECT:

TYPE:

Luminaire Ordering Information

PSCD6

1

2

3

1

Model
PSCD6

3

Finish
ANT - Anthracite Gray
BLK - Satin Black
CLB - Classic Bronze
SLV - Silver
WHT - White
CSTM - Custom

2

Performance Code
L27 - 2700K / 175mA
L30 - 3000K / 175mA
L40 - 4000K / 175mA
H27 - 2700K / 350mA
H30 - 3000K / 350mA
H40 - 4000K / 350mA
VH27 - 2700K / 700mA
VH30 - 3000K / 700mA
VH40 - 4000K / 700mA
AL - Amber Low
AH - Amber High

Back Box Ordering Information (Back Box must be ordered for a complete unit, ordered separately)

SQBX-6

1

1

Model
SQBX-6

Note: Back Box can be shipped ahead of the steplight, upon request.

Optional Adaptor Plate Ordering Information (see pg 4 for details)

For retrofit applications using an existing wall box or cavity.

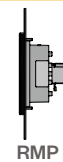
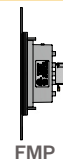

1

2

3

4

Model
FMP-PSCD6 - front mount adaptor plate
RMP-PSCx6 - rear mount adaptor plate

3

Mounting Hole Location
CRN - corner (1 in each corner)

2

Plate Size
----- x -----
(W) (H)

W: 8" min - 14" max
H: 8" min - 14" max

4

Finish
ANT - Anthracite Gray
BLK - Satin Black
CLB - Classic Bronze
SLV - Silver
WHT - White
CSTM - Custom

Note: A signed approval drawing showing the requested dimensions will be required to process an order.

Note: Back box is NOT used with this optional plate.

Passo SQ

6" Directional LED Recessed Wall Luminaire



Passo SQ 6" Directional Rec Wall Luminaire

PROJECT:

TYPE:

Construction Detail

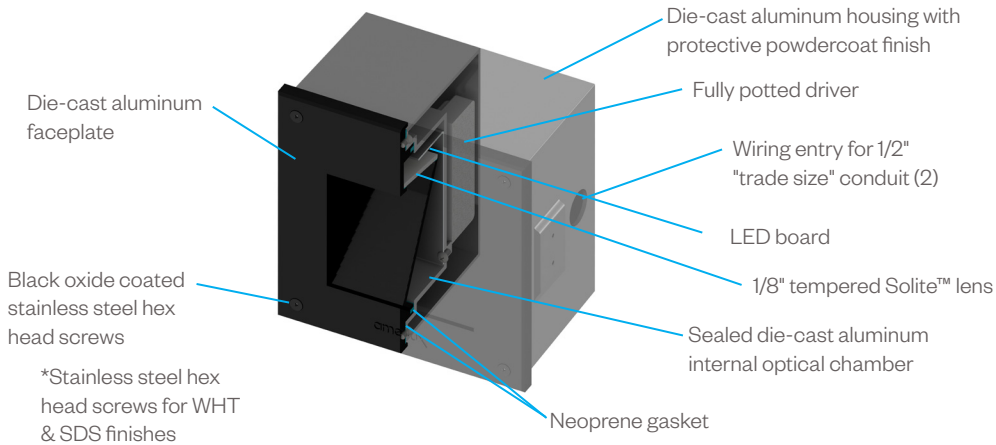

Application Brackets (included with order)

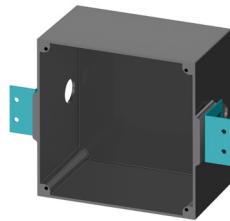

Horizontal Brackets
(Hollow Wall)

Performance Detail

PSCD6 Polar Graph

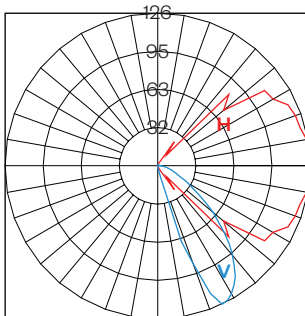

Performance Code	CCT/CRI	Approx. Lumens	Drive Current	Nominal Input Power
L27	2700K/80	68	175mA	4.2W
L30	3000K/80	71		
L40	4000K/70	76		
H27	2700K/80	95	350mA	8.1W
H30	3000K/80	100		
H40	4000K/70	106		
VH27	2700K/80	168	700mA	16.2W
VH30	3000K/80	177		
VH40	4000K/70	188		

Amber Option

Model Code	Output
PSCD6-AL	383 mW
PSCD6-AH	559 mW

Note: IES files available on our website. For VHxx data - use Hxx ies files with a 1.77 multiplier.

Passo SQ

6" Directional LED Recessed Wall Luminaire



PROJECT:

TYPE:

Adaptor Plate Detail

For retrofit applications using an existing wall box or cavity.

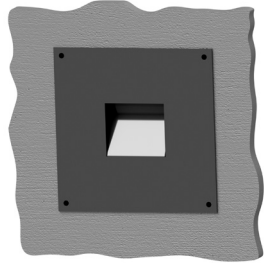

Front Mount Plate (FMP-PSCD6)

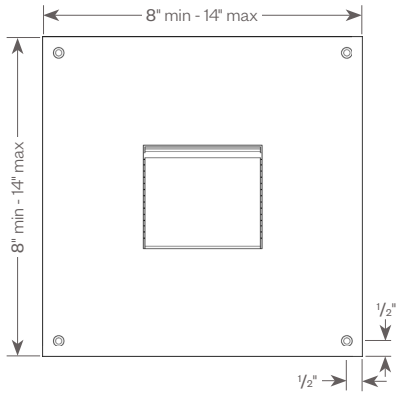

Standard dimensions from the corner are shown. If alternate dimensions are needed, please specify.

Space required to mount fixture.

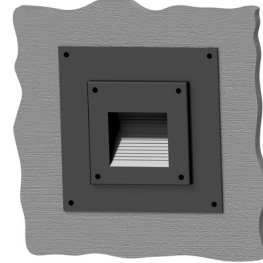
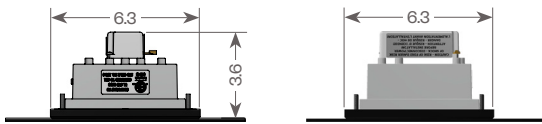

Rear Mount Plate (RMP-PSCx6)

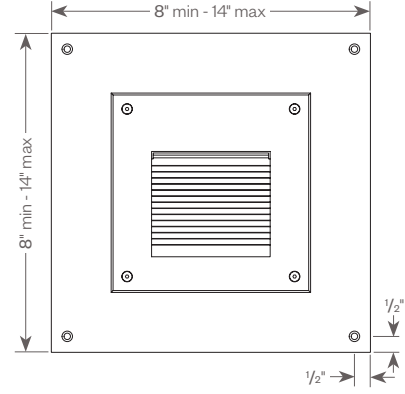

Standard dimensions from the corner are shown. If alternate dimensions are needed, please specify.

EDR Required for dimensions beyond the range shown.

Space required to mount fixture.

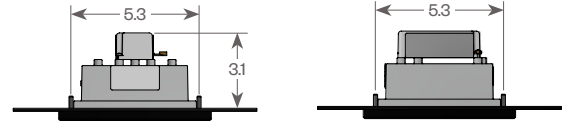

Note: A signed drawing will be required to process an order.

- 1 Model**
FMP-PSCD6 - front mount adaptor plate
RMP-PSCx6 - rear mount adaptor plate

- 2 Plate Size**
----- x -----
(W) (H)

W: 8" min - 14" max
H: 8" min - 14" max

- 3 Mounting Hole Location**
CRN - corner (1 in each corner)

- 4 Finish**
ANT - Anthracite Gray
BLK - Satin Black
CLB - Classic Bronze
SLV - Silver
WHT - White
CSTM - Custom