

DPS

Downlight Pendant-Small 18" LED Luminaire



Features

Improved performance, directional control, and efficacy allows this newest generation of the DPS to accommodate needs in the strictest environments. Multiple shade styles make this luminaire suitable for a wide variety of decorative applications, and the improved optics allow it to be used where Dark Sky luminaire requirements are in place.

Product Overview

Wattage:	43W, 49W, 63W, 70W
Lumen Output :	10,294 lm (70W, T3, 4000K)
Color Temp:	3000K, 4000K
Dimming:	0-10V dimming

* IDA Dark Sky approved in 3000K only

PROJECT:

TYPE:

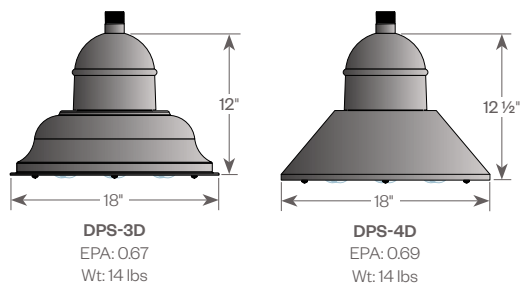
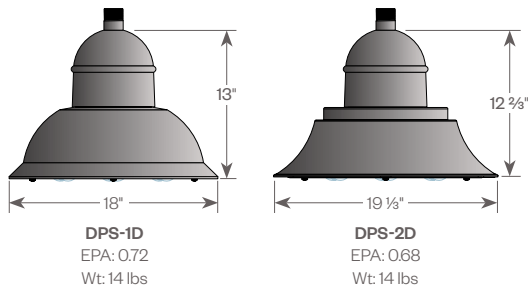

Installation:

The luminaire will mount to the bracket. Post top luminaire brackets will mount to a 3" OD post or tenon with (6) 5/16" stainless steel set screws. Wall bracket models have four 3/8" holes for mounting (wall mount hardware is not included).

Light Source:

The luminaire utilizes IP66 sealed optical modules consisting of a high performance LED board with an acrylic (TIR) lens to deliver maximum spacing and uniformity. A choice of Type II, Type III, Type IV, or Type V, IES distributions are available with the scalability to meet application criteria. Custom configurations available.

Driver:

Convection cooled driver with electronic constant current operation with over voltage and short circuit protection. Automatic voltage sensing for 120V to 277V input. 0-10V dimming.

Finish:

Durable thermoset polyester powder coat finish in the following:

- Satin Black (**BLK**)
- Classic Bronze (**CLB**)
- Gloss Textured Bronze (**GBZ**)
- Green (**GRN**)
- Gloss Textured Black (**GTB**)
- Textured Black (**TBK**)
- Gloss Textured Green (**TGR**)

Accessories:

- Backlight Shield
- Wireless control option

ETL listed, suitable for wet locations.

PROJECT:

TYPE:

Ordering Information



- | | |
|-------------------------------------------------------------------------------------------------------------------------------------------------------------------------------------------------------------------------------------------------------------------------------------------------------------------------------------------------------------------------------------|------------------------------------------------------------------------------------------------------------------------------------------------------------------------------------------------------------------------------------------------------------------------------------------------------------------------------------------------------------------------------------------------------------------------------------------------------------------------------------------------------------|
| <p>1 <u>Model</u>
DPS-1D
DPS-2D
DPS-3D
DPS-4D</p> <p>2 <u>LED Modules</u>
2M - 2 Modules
3M - 3 Modules</p> <p>3 <u>Light Distribution</u>
T2 - Type II
T3 - Type III
T4 - Type IV
T5 - Type V</p> <p>4 <u>Color Temp</u>
30* - 3000K
40 - 4000K
* DarkSky International approved in 3000K only</p> | <p>5 <u>Power Level</u>
530M
600M</p> <p>6 <u>Finish</u>
BLK - Satin Black
CLB - Classic Bronze
GBZ - Gloss Textured Bronze
GRN - Green
GTB - Gloss Textured Black
TBK - Textured Black
TGR - Gloss Textured Green
CSTM - Custom</p> <p>7 <u>Options/Accessories</u>
BLS - Backlight Shield (T2, T3 & T4 distributions only)
SSINT-1 - Integrated Wireless Control Node
(for operation on the SmartSite control platform)</p> |
|-------------------------------------------------------------------------------------------------------------------------------------------------------------------------------------------------------------------------------------------------------------------------------------------------------------------------------------------------------------------------------------|------------------------------------------------------------------------------------------------------------------------------------------------------------------------------------------------------------------------------------------------------------------------------------------------------------------------------------------------------------------------------------------------------------------------------------------------------------------------------------------------------------|

Mounting Ordering Information (see pg 3 for details)

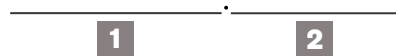

- | | |
|-------------------------------------------------------------------------------------------------------------------------------------------------------------------------------------------------------------------------------------------------------------------------------------------------------------------------------------------------------|---------------------------------------------------------------------------------------------------------------------------------------------------------------------------------------------------------------------------------------|
| <p>1 <u>Model</u>
PT01 - pendant crook, single arm
PT12 - pendant crook, double arm
WBR03 - wall bracket
WBR06-13PM - wall bracket with 13" extension arm
WBR06-15PM - wall bracket with 15" extension arm
CBR40-1-24-S - pendant bracket, single arm, 24"
CBR40-2-24-S - pendant bracket, double arm, 24" ea.</p> | <p>2 <u>Finish</u>
BLK - Satin Black
CLB - Classic Bronze
GBZ - Gloss Textured Bronze
GRN - Green
GTB - Gloss Textured Black
TBK - Textured Black
TGR - Gloss Textured Green
CSTM - Custom</p> |
|-------------------------------------------------------------------------------------------------------------------------------------------------------------------------------------------------------------------------------------------------------------------------------------------------------------------------------------------------------|---------------------------------------------------------------------------------------------------------------------------------------------------------------------------------------------------------------------------------------|

PROJECT:

TYPE:

Assembly Details

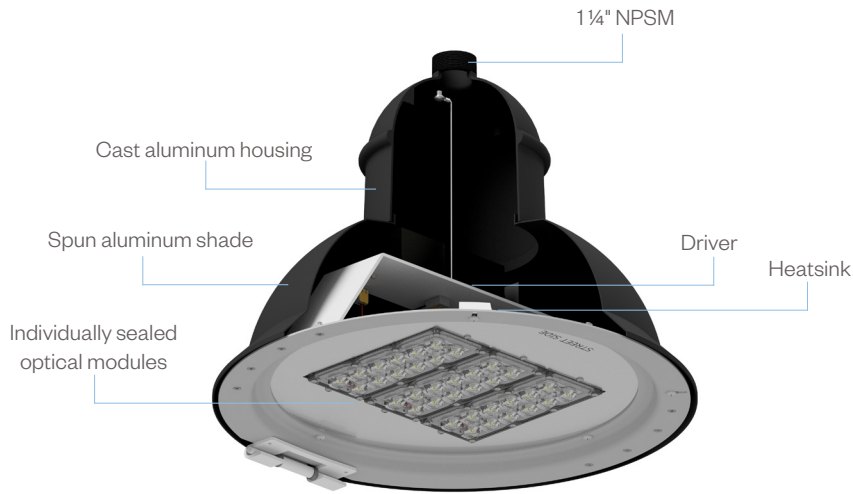

Mounting Options

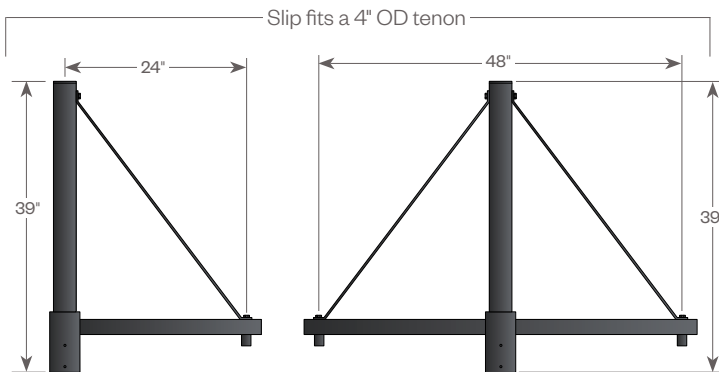
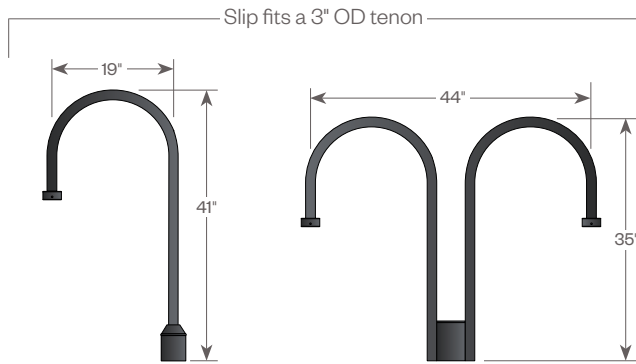

Wall Brackets

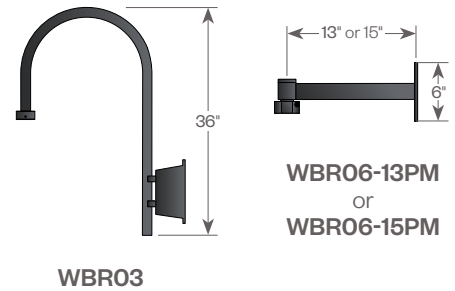

PROJECT:

TYPE:

Power

LED Modules	2M		3M	
Power	43W	49W	63W	70W
Amperage Draw @ 120V (A)	0.36	0.41	0.53	0.58
Amperage Draw @ 277V (A)	0.16	0.18	0.23	0.25

Performance Chart

Modules	System Watts	Distribution	CCT	Luminaire Lumens		Bug Rating
				530mA	600mA	
2M	43W (530mA) 49W (600mA)	T2	3,000K	5981	6501	1-0-1
			4,000K	6340	6891	
		T3	3,000K	6093	6623	
			4,000K	6459	7020	
		T4	3,000K	5795	6299	1-0-2
			4,000K	6143	6677	
		T5	3,000K	5966	6485	3-0-1
			4,000K	6324	6874	
3M	63W (530mA) 70W (600mA)	T2	3,000K	8769	9532	2-0-2
			4,000K	9295	10104	
		T3	3,000K	8934	9711	
			4,000K	9470	10294	
		T4	3,000K	8497	9236	
			4,000K	9007	9790	
		T5	3,000K	8748	9509	3-0-2
			4,000K	9273	10080	

Lumen Maintenance

Ambient Temp	50,000 Hours*	70,000 Hours*	90,000 Hours*	100,000 Hours*	Theoretical L70 Hours
25°C	>95.4%	>93.9%	>92.4%	>91.6%	>200,000

* Per IESNA TM-21 data

Lumen maintenance values apply to all output levels and distributions.

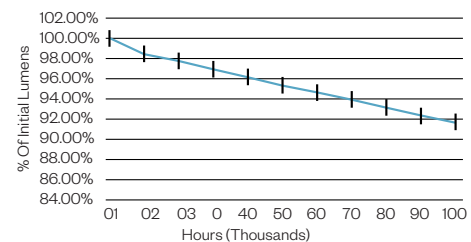

PROJECT:

TYPE:

Performance

DPS-xD-2M-T2-30-600M

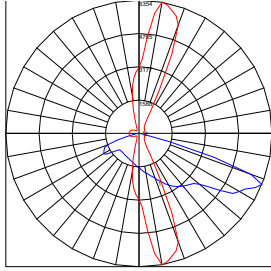

Typical T2 Polar Plot

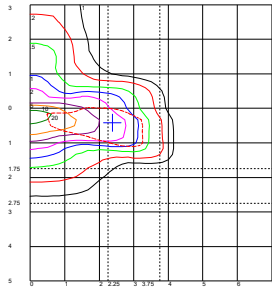

Typical T2 Isolines

DPS-xD-2M-T3-30-600M

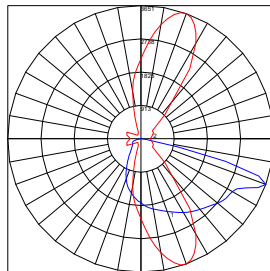

Typical T3 Polar Plot

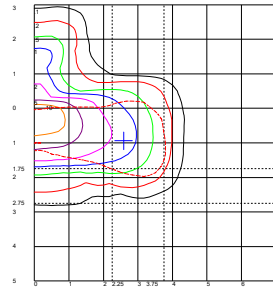

Typical T3 Isolines

DPS-xD-2M-T4-30-600M

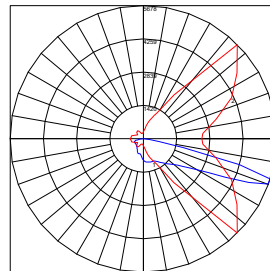

Typical T4 Polar Plot

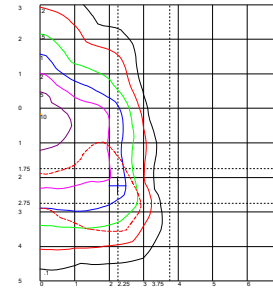

Typical T4 Isolines

DPS-xD-2M-T5-30-600M

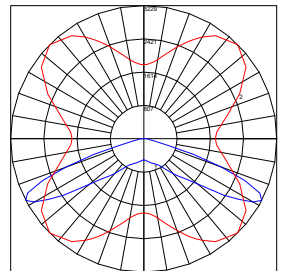

Typical T5 Polar Plot

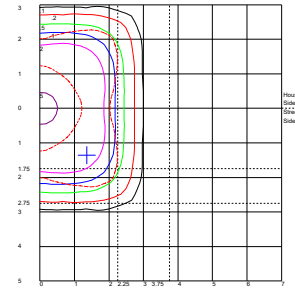

Typical T5 Isolines

Backlight Shield (BLS)

Shield can be easily installed in the field when required.

